



®

***gaskets***



**2017**

**CATÁLOGO DE APLICACIONES  
/CATALOG OF APPLICATIONS**

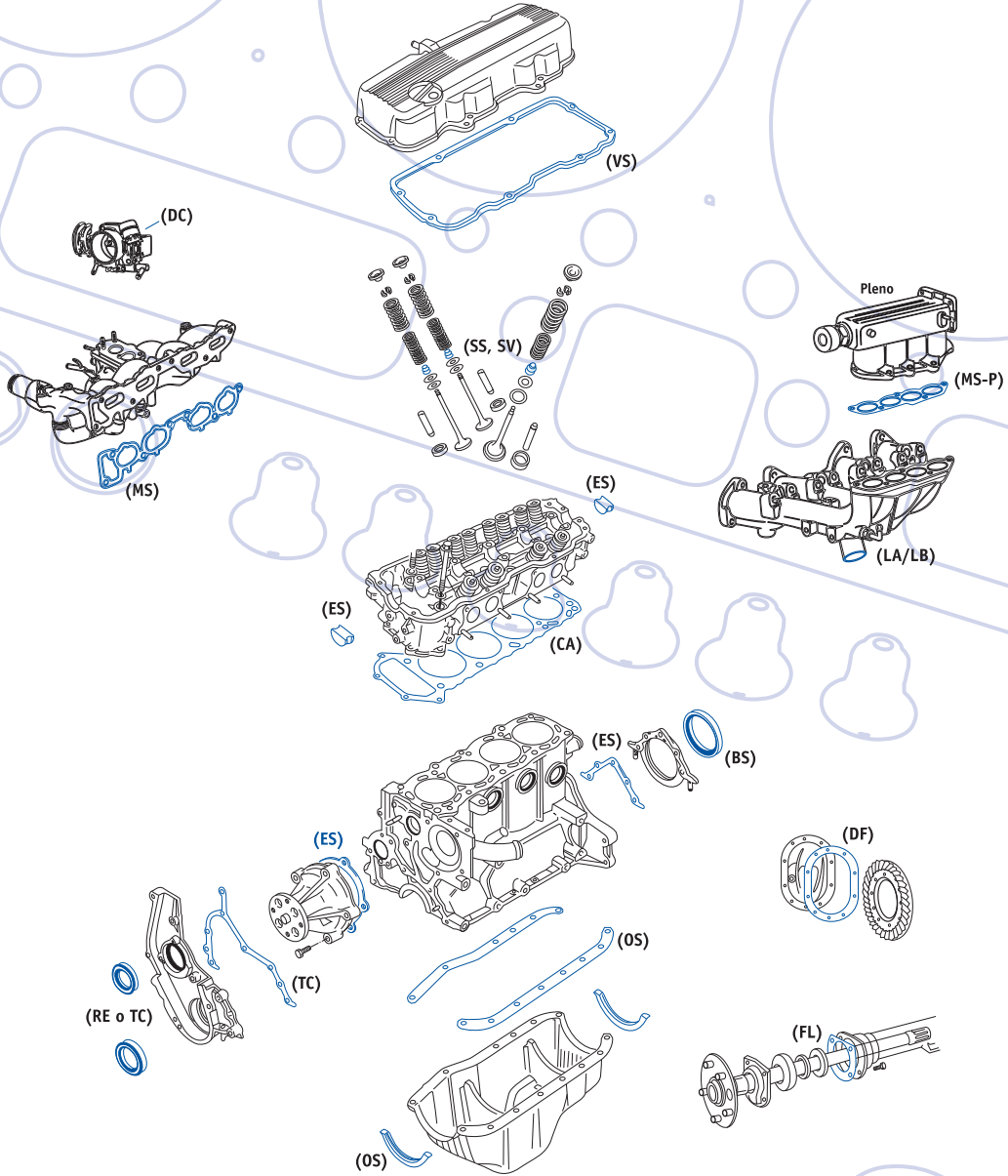

- FS** \_\_\_\_\_ Juego Completo  
Full Set
- HS** \_\_\_\_\_ Juego Superior  
Head Set
- LS** \_\_\_\_\_ Juego Inferior  
Lower Set
- CA** \_\_\_\_\_ Junta de Cabeza  
Head Gasket
- MS** \_\_\_\_\_ Múltiple de Admisión  
Intake Manifold
- MS-E /MS-P** \_\_\_\_\_ Múltiple de Escape y Pleno  
Exhaust and Plenum
- OS** \_\_\_\_\_ Cárter  
Oil Pan Set

- VS** \_\_\_\_\_ Tapa de Punterías  
Valve Cover
- TC** \_\_\_\_\_ Distribución  
Timing Cover
- BS** \_\_\_\_\_ Retén Cigüeñal  
Crank Seal
- RE** \_\_\_\_\_ Retén  
Oil Seal
- SS - SV** \_\_\_\_\_ Sellos de Válvula  
Valve Stem Seals
- LA - LB** \_\_\_\_\_ Aro / Tubo de Escape  
Exhaust Ring / Gasket

DC: Junta de Carburador / Carburetor Gasket  
 ES: Junta Varias / Miscellaneous Gaskets  
 DF: Junta Diferencial / Differential Gasket  
 FL: Junta Flecha Lateral / Shaft wheel Gasket





## Juntas de Cabeza

En **Grafito** con materiales premium y recubrimiento **epóxico termo estable**, resistente a la temperatura que ayuda al anclaje de su segundo recubrimiento de silicón para lograr un sellado eficiente.

**Multilamina** con acero de alta resistencia al igual que sus recubrimientos tales como: **Viton®**, **NBR** y **Silicón**.

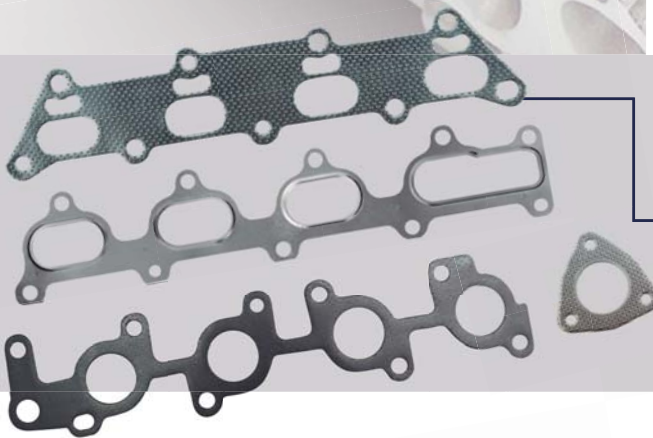
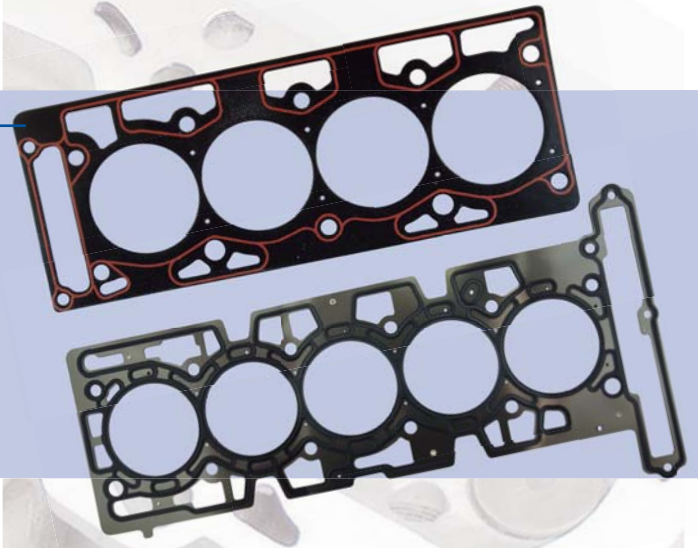

## Múltiples aros y juntas planas de escape

Fabricados todos en **grafito expandido** que resiste muy elevadas temperaturas y con excelente compresibilidad para absorber imperfecciones en las superficies a sellar.

## Admisión y empaques varios

Fabricados en **fibras sintéticas** que cubren requerimientos ASTM (American Society for Testing and Materials) en resistencia a altas temperaturas y compresibilidad como principales características en el sellado.

Empaques en **Nylon-Silicón** o bien como sustituto en **diseño DC de multi-capas a base de fibras sintéticas, lámina y recubrimiento epóxico termo-estable** que cubren toda la superficie de sellado con mayor garantía de resistencia.

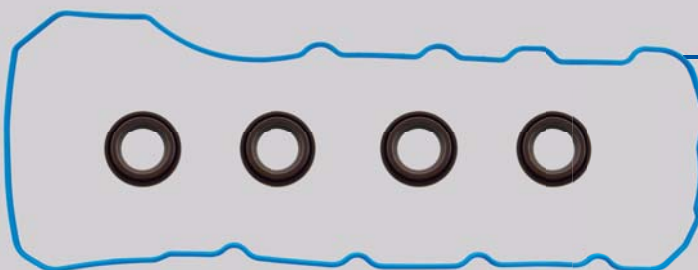
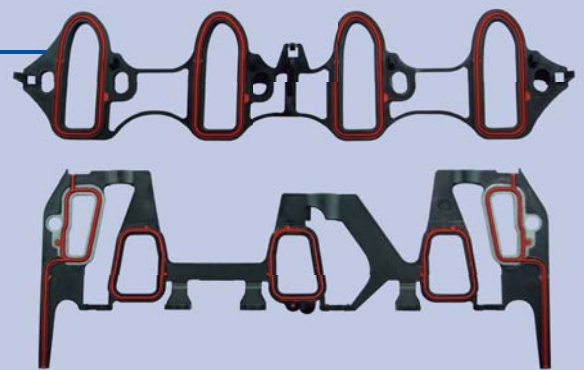

## Juntas y sellos de hule

Se usan materias primas de alto desempeño para uso automotriz como son **Teflon®**, **Viton®**, **Silicón**, **Poli acrilato** y **Nitrilo**, entre otras.



*Teflon® es una marca registrada de DuPont.  
Viton® es un producto de DuPont Performance Elastomers.*



## Head Gaskets

In **Graphite** with **premium materials** and thermal epoxy coating for a stable sealing and heat resistant working on his second silicone coating to achieve an efficient sealing.

**MLS** head gasket high performance steel and coating such as **Viton®**, **NBR** and **Silicone**.

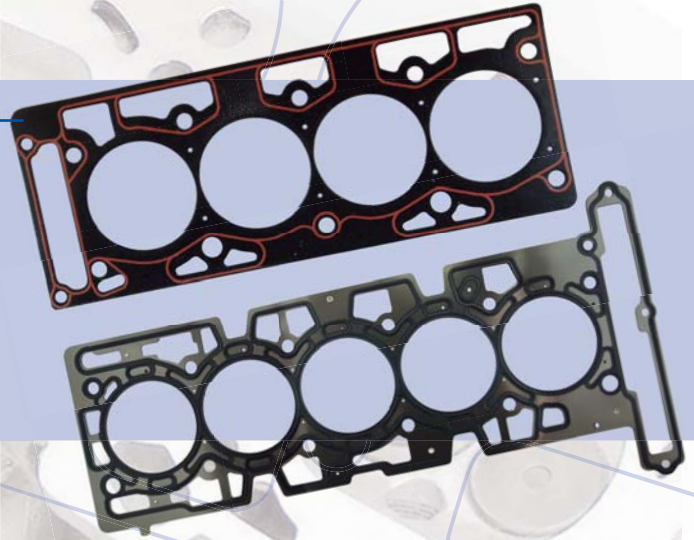

## Exhaust Manifold, rings and exhaust flat gaskets

All manufactured in **expanded graphite** which resists high temperatures and excellent compressibility to absorb imperfections in the surfaces to be sealed.

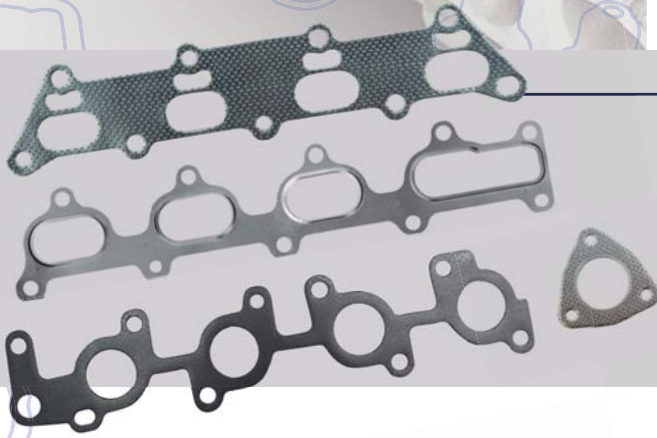

## Intake and Miscellaneous gaskets

Various gaskets including the intake gaskets, are manufactured of synthetic fibers covering **ASTM** ( American Society for Testing and Materials) standars about high temperature resistance and compressibility as main characteristics for sealing requirements.

Nylon-Silicone gaskets or its substitute on DC design about multi layer of fiber and steel with a thermo stable epoxi coating achieving a performance sealing for covering entire sealing surface.

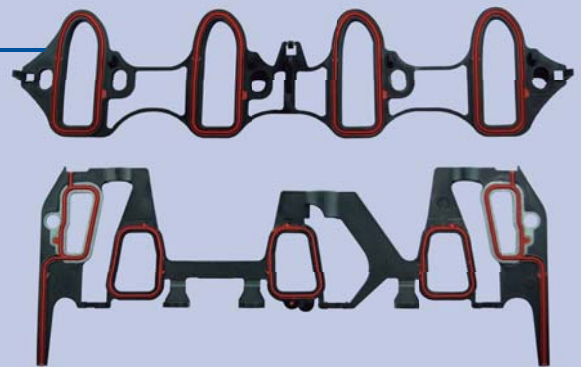

## Rubber Gaskets and Seals

Manufactured with high performance materials for automotive use, Such as **Teflon®**, **Viton®**, **Silicone**, **Polyacrylate NBR**, and others.

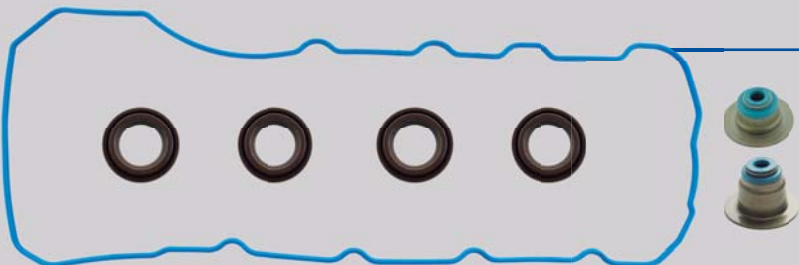

**\* JUEGOS COMPLETOS**



1.5L	MOTOR	MODELOS	DESDE / A	JUNTA DE CABEZA	MULTIPLE DE ADMISIÓN O PLENO
ENGINE	MODELS	FROM / TO	HEAD GASKET	INTAKE	
4L SOHC 8V E15	TSURU	1983/1988	CA-1216-G	MS-41216-A	
<b>PS-1216</b>					
MULTIPLE DE ESCAPE		PUNTERIAS		CARTER	
EXHAUST		VALVE COVER		OIL PAN	
MS-41216-E		VS-31216-R		OS-11216	
DISTRIBUCIÓN		RETÉN CIGÜEÑAL		SELLOS DE VALVULA	
TIMING COVER		CRANK SEAL		STEM SEALS	
TC-61216		BS-71216		SS-81216	
				JUNTAS VARIAS	
				MISCELLANEOUS	

- 01 Muestra que el catálogo esta ordenado por marca.
- 02 Litraje del motor, siendo ordenado de manera ascendente.
- 03 Indica las características del motor
- 04 Modelo
- 05 Año de la fabricación del motor y modelo.

\* En cada indice por marca de la sección de **Juegos Completos** existe un código QR el cual al escanearlo con su spartphone lo dirigirá a la página del catálogo digital para una búsqueda más específica de juegos no impresos en este catálogo.

Identifiquelo con la siguiente imagen:



DC gaskets		2017	INDICE / INDEX	
CATÁLOGO DE APLICACIONES / APPLICATION CATALOG		JUEGOS COMPLETOS / FULL SET		
		TOYOTA		
LITROS	MODELO	AÑO	PAGINA	
LITERS	MODEL	YEAR	PAGE	
1.5L	TERCEL	1980/1988	*	
1.5L	TERCEL	1987/1994	*	
1.5L	TERCEL PRASEO	1992/1995	*	
1.5L	TERCEL PRASEO	1992/1999	*	
1.4L	COROLLA CABRINA	1977/1979	1	
1.6L	COROLLA CELICA GEO PRIZM	1988/1993	*	
1.6L	COROLLA PRIZM	1993/1997	*	
1.8L	CELICA COROLLA MIRZ MATRIX PONTIAC VIBE PRIZM	1998/2009	*	
1.8L	COROLLA CELICA GEO PRIZM	1997/1997	*	
2.0L	CELICA CAMRY	1983/1986	*	
2.0L	VAN CARGA	1984/1985	*	
2.0L	CAMRY CELICA MIRZ	1987/1991	1	
2.0L	RAV4	2001/2003	1	
2.3L	CELICA CORONA PICKUP	1979/1980	1	
2.3L	MIRZ TURBO	1991	*	
2.3L	VAN CARGA PASAJEROS	1986/1989	1	
2.3L	CAMRY CELICA MIRZ	1993/1995	1	
2.4L	PICKUP CORONA CELICA	1981/1982	1	
2.4L	PICKUP CELICA HRUNNER	1983/1984	1	
2.4L	PICKUP CELICA HRUNNER	1985/1995	1	
2.4L	PRIZM	1991/1997	*	
2.4L	PANV CAMRY HIGHLANDER	2002/2007	*	
2.4L	TACOMA	1994/2004	*	
2.7L	TACOMA T100 HRUNNER	1994/2004	*	
2.7L	HACE HUELA VENZA	2005/2010	1	
3.0L	HRUNNER PICKUP T100	1988/1995	1	
3.0L	SUPRA LEXUS SCION ESSEX G350G	1993/1996	*	
3.0L	CAMRY LEXUS ES300	1992/1995	*	
3.0L	CAMRY HRUNNER SUPRA SOLARA	1994/2000	*	
3.4L	TACOMA HRUNNER T100 TUNDRA	1995/2004	1	
4.0L	LEXUS L460 SC400	1990/1997	*	
4.0L	LEXUS GS400 LS400 SC400	1989/2000	*	
4.0L	LAND CRUISER	1988/1992	*	
4.2L	LAND CRUISER	1985/1987	*	
4.7L	HINO SERIE 500	2009/2014	1	

**NOTA:** Asegúrese de colocar correctamente la imagen, para una lectura correcta.

\* Otra manera de dirigirse a nuestro catálogo digital es en: [catalogo.dcp.com.mx](http://catalogo.dcp.com.mx)

En cualquiera de estas dos opciones le deberá arrojar la siguiente pantalla:

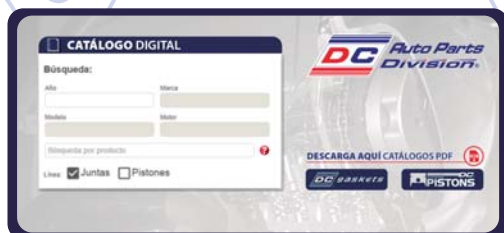



\* FULL SET



1.5L	MOTOR	MODELOS	DESDE / A	JUNTA DE CABEZA	MULTIPLE DE ADMISION O PLENO
ENGINE	MODELS	FROM / TO	HEAD GASKET	INTAKE	
4L SOHC 8V E15	TSURU I	1983/1985	CA-1216-G	MS-41216-A	
FS-1216			MULTIPLE DE ESCAPE	PUNTERIAS	CARTER
			EXHAUST	VALVE COVER	OIL PAN
			MS-41216-E	VS-31216-R	OS-11216
DISTRIBUCION	RETÉN CIGÜERAL	SELLOS DE VALVULA	JUNTAS VARIAS		
TIMING COVER	CRANK SEAL	STEM SEALS	MISCELLANEOUS		
TC-41216	BS-71216	SS-81216			

- 01 Shows the catalog is ordered by manufacturer.
- 02 Engine size, in ascending form.
- 03 Indicates engine specifications.
- 04 Car and truck models.
- 05 Year reference of engine and model.

\* Each Make index in the Full Set Section, will shows a QR code to be scanned by smartphones and redirecting you to the website (Digital Catalog) with a new sort for all the Full Sets does not show in this catalog.

QR image reference.



LITROS		MODELO	AÑO	PÁGINA
LITERS	MODEL	YEAR	PAGE	
1.5L	TERCEL	1980/1988	*	
1.5L	TERCEL	1987/1994	*	
1.5L	TERCEL PASO	1992/1995	*	
1.5L	TERCEL PASO	1995/1999	*	
1.5L	TERCEL PASO	1977/1979	*	
1.6L	COROLLA	1988/1993	*	
1.6L	COROLLA CELICA GEO PRIZM	1993/1997	*	
1.6L	COROLLA PRIZM	1993/1997	*	
1.6L	CELICA COROLLA MRZ MATRIX PONTIAC VIBE PRIZM	1998/2009	*	
1.6L	COROLLA CELICA GEO PRIZM	1993/1997	*	
1.6L	CELICA CAMRY	1983/1988	*	
2.0L	WAN CARGA	1984/1985	*	
2.0L	CAMRY CELICA MRZ	1987/1993	*	
2.0L	RAVA	2001/2003	*	
2.2L	CELICA CORONA PICK-UP	1975/1980	*	
2.2L	MRZ TURBO	1991	*	
2.2L	WAN CARGA / PALADINOS	1986/1989	*	
2.2L	CAMRY CELICA MRZ	1983/1993	*	
2.4L	PICK-UP CORONA CELICA	1981/1982	*	
2.4L	PICK-UP CELICA 4RUNNER	1983/1984	*	
2.4L	PICK-UP CELICA 4RUNNER	1983/1993	*	
2.4L	PREVIA	1991/1997	*	
2.4L	BAVA CAMRY HIGHLANDER	2002/2007	*	
2.4L	TACOMA	1994/2004	*	
2.7L	TACOMA 100 4RUNNER	1994/2004	*	
2.7L	HACE HELIX VENZA	2005/2010	*	
3.0L	4RUNNER PICK-UP 1100	1988/1995	*	
3.0L	SUNRA LEXUS SCION ESQO GSSD	1993/1998	*	
3.0L	CAMRY 4RUNNER HONDA SOLARA	1994/2000	*	
3.4L	TACOMA 4RUNNER 1-100 TUNDRA	1995/2004	*	
4.0L	LEXUS LAMB SC400	1990/1997	*	
4.0L	LEXUS GLEAM LEXUS SC400	1988/2000	*	
4.0L	LAND CRUISER	1988/1992	*	
4.2L	LAND CRUISER	1983/1987	*	
4.7L	HINO SERRA 500	2008/2014	*	

NOTE: Make sure to have the QR image in the correctly position for a success reading.

\* Another way to link our digital catalog is at: [catalogo.dcp.com.mx](http://catalogo.dcp.com.mx)

In either of these two options will display the following screen:

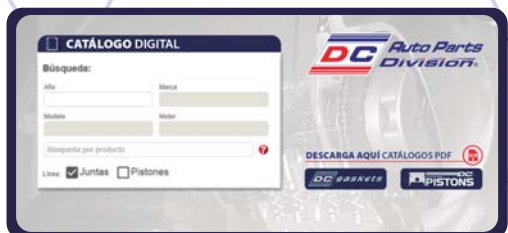

<b>NOMENCLATURA / NOMENCLATURE</b>	I
<b>MATERIALES Y ATRIBUTOS / MATERIALS AND ATTRIBUTES</b>	III
<b>COMO USAR ESTE CATÁLOGO / HOW TO USE THIS CATALOG</b>	V
<b>INDICE GENERAL / GENERAL INDEX</b>	VII
<b>SECCIÓN JUEGOS COMPLETOS / FULL SETS SECTION</b>	
-AMC JEEP	1
-CHRYSLER	13
-FORD	49
-GENERAL MOTORS	91
-HONDA	133
-ISUZU	139
-MAZDA	145
-NISSAN	153
-RENAULT	173
-TOYOTA	179
-VOLKSWAGEN	191
<b>JUNTAS DE CABEZA / HEAD GASKETS</b>	203
<b>JUNTAS EN SOBREMEDIDA / OVER SIZE HEAD GASKETS</b>	273
<b>APLICACIONES DIESEL / DIESEL APPLICATIONS</b>	279
<b>SELLOS DE VÁLVULA / STEAM SEALS</b>	289
<b>RETENES / OIL SEALS</b>	301
<b>JUNTAS DE ESCAPE / EXHAUST GASKETS</b>	305
<b>NUEVOS PRODUCTOS / NEW INTEGRATIONS</b>	325
<b>INTERCAMBIOS / INTERCHANGES</b>	339





El catálogo de aplicaciones DC es el resultado de una ardua labor que combina experiencia, investigación, conocimientos y una valiosa recopilación de datos sumamente útiles para el mecánico automotriz. Sin embargo, la empresa no se hace responsable por errores u omisiones que pudiera tener el catálogo, ya que el contenido se presenta como información complementaria.

Agradecemos su preferencia

---

The DC catalog for engine gasket applications is the result after an arduous work, wich combine experience, research and knowledge, besides a valuable gathering of data, greatly useful for automotive mechanics. However DC company is not responsible for errors or missing information in the catalog, due to the shown contents are complementary details only.

We appreciate your preference.



**AMC, JEEP**

**MARCA  
/MAKE**

CATÁLOGO DE APLICACIONES / APPLICATION CATALOG









LITROS	MODELO	AÑO	PÁGINA
LITERS	MODEL	YEAR	PAGE
<b>2.5L</b>	EAGLE, WAGONEER, CHEROKEE, WRANGLER	1983/1985	<b>5</b>
<b>2.5L</b>	COMANCHE, CJ7, WRANGLER, WAGONEER	1986/1990	<b>5</b>
<b>3.2L</b>	EAGLE, RAMBLER AMERICAN, PACER, AMBASSADOR, JAVELIN	1965/1983	<b>6</b>
<b>3.7L</b>	DAKOTA, RAM 1500, JEEP LIBERTY (CABEZA EN GRAFITO)	2002/2005	<b>39</b>
<b>3.7L</b>	DAKOTA, RAM 1500, JEEP LIBERTY (CABEZA EN MLS)	2002/2005	<b>40</b>
<b>3.8L</b>	EAGLE, RAMBLER AMERICAN, PACER, AMBASSADOR, JAVELIN	1965/1983	<b>6</b>
<b>4.0L</b>	EAGLE, CHEROKEE, WAGONEER, COMANCHE	1987/1990	<b>7</b>
<b>4.0L</b>	EAGLE, CHEROKEE, COMANCHE, WRANGLER	1991/1995	<b>7</b>
<b>4.0L</b>	CHEROKEE, WRANGLER	1996/1998	<b>8</b>
<b>4.0L</b>	CHEROKEE, WRANGLER	1999/2006	<b>8</b>
<b>4.2L</b>	EAGLE, RAMBLER AMERICAN, PACER, AMBASSADOR, JAVELIN	1965/1983	<b>9</b>
<b>4.2L</b>	EAGLE, WRANGLER, CJ7, J10	1986/1988	<b>9</b>
<b>4.2L</b>	EAGLE, GRAND WAGONEER, WRANGLER	1985/1989	<b>10</b>
<b>4.6L</b>	EAGLE, RAMBLER AMERICAN, PACER, WAGONEER, JAVELIN	1965/1987	<b>10</b>
<b>4.7L</b>	RAM 1500, 2500, GRAND CHEROKEE, DURANGO, DAKOTA (CABEZA EN GRAFITO)	1999/2005	<b>43</b>
<b>4.7L</b>	RAM 1500, 2500, GRAND CHEROKEE, DURANGO, DAKOTA (CABEZA EN MLS)	1999/2005	<b>44</b>
<b>5.6L</b>	AMBASSADOR, JAVELIN, RAMBLER	1967/1974	<b>*</b>
<b>5.2L</b>	RAM 1500, 2500, 3500, DURANGO, GRAND CHEROKEE, B1500, 2500, 3500.	1992/2002	<b>45</b>
<b>5.7L</b>	RAM 1500, 2500, 3500, DURANGO, GRAND CHEROKEE, COMANDER	2003/2009	<b>46</b>
<b>5.9L</b>	AMBASSADOR, JAVELIN, MATADOR, CHEROKEE, WAGONEER, GRAND WAGONNER.	1971/1991	<b>11</b>
<b>6.4L</b>	AMBASSADOR, JAVELIN, RAMBLER.	1971/1978	<b>*</b>
<b>6.6L</b>	AMBASSADOR, JAVELIN, MATADOR, CHEROKEE, WAGONNER.	1971/1983	<b>*</b>





2.5L	MOTOR	MODELOS	DESDE / A	JUNTA DE CABEZA	MULTIPLE DE ADMISIÓN O PLENO
ENGINE	MODELS	FROM / TO	HEAD GASKET	INTAKE	
4L AMC OHV 8V VIN U,C	EAGLE, WAGONEER, CHEROKEE, WRANGLER	1983/1985	CA-703-G 	MS-4703 	
FS-703 			MULTIPLE DE ESCAPE EXHAUST N/A	PUNTERIAS VALVE COVER VS-3703-R 	CARTER OIL PAN OS-1703 
DISTRIBUCIÓN TIMING COVER TC-6710 	RETÉN CIGÜEÑAL CRANK SEAL BS-7703 	SELLOS DE VALVULA STEM SEALS SS-8140-8P 	JUNTAS VARIAS MISCELLANEOUS		

2.5L	MOTOR	MODELOS	DESDE / A	JUNTA DE CABEZA	MULTIPLE DE ADMISIÓN O PLENO
ENGINE	MODELS	FROM / TO	HEAD GASKET	INTAKE	
4L AMC OHV 8V VIN U, H	COMANCHE, CJ7, WRANGLER, WAGONEER	1986/1990	CA-703-G 	MS-4703 	
FS-703-1 			MULTIPLE DE ESCAPE EXHAUST N/A	PUNTERIAS VALVE COVER VS-3703-R 	CARTER OIL PAN OS-1703 
DISTRIBUCIÓN TIMING COVER TC-6710 	RETÉN CIGÜEÑAL CRANK SEAL BS-7703 	SELLOS DE VALVULA STEM SEALS SS-8140-8P 	JUNTAS VARIAS MISCELLANEOUS		





3.2L	MOTOR	MODELOS	DESDE / A	JUNTA DE CABEZA		MÚLTIPLE DE ADMISIÓN O PLENO	
ENGINE	MODELS	FROM / TO	HEAD GASKET		INTAKE		
L6 OHV 12V 199"	EAGLE, RAMBLER AMERICAN, PACER, AMBASSADOR, JAVELIN	1965/1983	CA-710-G		MS-4711		
FS-710							
		MÚLTIPLE DE ESCAPE		PUNTERIAS	CARTER		
		EXHAUST		VALVE COVER	OIL PAN		
		N/A		VS-3710	OS-1710		
		N/A					
DISTRIBUCIÓN		RETÉN CIGÜEÑAL		SELLOS DE VALVULA		JUNTAS VARIAS	
TIMING COVER		CRANK SEAL		STEM SEALS		MISCELLANEOUS	
TC-6710		BS-7710		SS-8710			

3.8L	MOTOR	MODELOS	DESDE / A	JUNTA DE CABEZA		MÚLTIPLE DE ADMISIÓN O PLENO	
ENGINE	MODELS	FROM / TO	HEAD GASKET		INTAKE		
L6 OHV 12V 232"	EAGLE, RAMBLER AMERICAN, PACER, AMBASSADOR, JAVELIN	1965/1983	CA-710-G		MS-4711		
FS-710							
		MÚLTIPLE DE ESCAPE		PUNTERIAS	CARTER		
		EXHAUST		VALVE COVER	OIL PAN		
		N/A		VS-3710	OS-1710		
		N/A					
DISTRIBUCIÓN		RETÉN CIGÜEÑAL		SELLOS DE VALVULA		JUNTAS VARIAS	
TIMING COVER		CRANK SEAL		STEM SEALS		MISCELLANEOUS	
TC-6710		BS-7710		SS-8710			



4.0L	MOTOR	MODELOS	DESDE / A	JUNTA DE CABEZA		MÚLTIPLE DE ADMISIÓN O PLENO
ENGINE		MODELS	FROM / TO	HEAD GASKET		INTAKE
L6 AMC OHV 12V 242"	EAGLE, CHEROKEE, WAGONEER, COMANCHE	1987/1990	CA-715-G			MS-4715 
<b>FS-715</b> 						
DISTRIBUCIÓN TIMING COVER		RETÉN CIGÜEÑAL CRANK SEAL	SELLOS DE VALVULA STEM SEALS	PUNTERIAS VALVE COVER		CARTER OIL PAN
TC-6710 	BS-7710 	SS-8141-V 	VS-003715 		OS-1710 	
JUNTAS VARIAS MISCELLANEOUS						

4.0L	MOTOR	MODELOS	DESDE / A	JUNTA DE CABEZA		MÚLTIPLE DE ADMISIÓN O PLENO
ENGINE		MODELS	FROM / TO	HEAD GASKET		INTAKE
L6 AMC OHV 12V 242"	EAGLE, CHEROKEE, COMANCHE, WRANGLER	1991/1995	CA-715-G			MS-4715-1 
<b>FS-715-1</b> 						
DISTRIBUCIÓN TIMING COVER		RETÉN CIGÜEÑAL CRANK SEAL	SELLOS DE VALVULA STEM SEALS	PUNTERIAS VALVE COVER		CARTER OIL PAN
TC-6710 	BS-7710 	SS-8141-V 	VS-3715 		OS-1715-R 	
JUNTAS VARIAS MISCELLANEOUS						



4.0L	MOTOR	MODELOS	DESDE / A	JUNTA DE CABEZA		MÚLTIPLE DE ADMISIÓN O PLENO	
ENGINE	MODELS	FROM / TO	HEAD GASKET		INTAKE		
L6 AMC OHV 12V 242"	CHEROKEE, WRANGLER	1996/1998	CA-715-G		MS-4715-1		
FS-715-2			MÚLTIPLE DE ESCAPE		PUNTERIAS	CARTER	
			EXHAUST		VALVE COVER	OIL PAN	
			N/A		VS-3715	OS-1715-R	
			N/A				
DISTRIBUCIÓN		RETÉN CIGÜEÑAL		SELLOS DE VALVULA		JUNTAS VARIAS	N/A
TIMING COVER		CRANK SEAL		STEM SEALS		MISCELLANEOUS	
TC-6710		BS-7715		SS-8141-V		N/A	

4.0L	MOTOR	MODELOS	DESDE / A	JUNTA DE CABEZA		MÚLTIPLE DE ADMISIÓN O PLENO	
ENGINE	MODELS	FROM / TO	HEAD GASKET		INTAKE		
L6 OHV 12V 242"	CHEROKEE, WRANGLER	1999/2006	CA-715-G		MS-004715-2		
FS-715-3			MÚLTIPLE DE ESCAPE		PUNTERIAS	CARTER	
			EXHAUST		VALVE COVER	OIL PAN	
			N/A		VS-3715-1R	OS-1715-R	
			N/A				
DISTRIBUCIÓN		RETÉN CIGÜEÑAL		SELLOS DE VALVULA		JUNTAS VARIAS	N/A
TIMING COVER		CRANK SEAL		STEM SEALS		MISCELLANEOUS	
TC-6710		BS-7715				N/A	





4.2L	MOTOR	MODELOS	DESDE / A	JUNTA DE CABEZA		MÚLTIPLE DE ADMISIÓN O PLENO	
ENGINE	MODELS	FROM / TO	HEAD GASKET		INTAKE		
L6 OHV 12V 258"	EAGLE, RAMBLER AMERICAN, PACER, AMBASSADOR, JAVELIN	1965/1983	CA-710-G		MS-4711		
FS-710							
			MÚLTIPLE DE ESCAPE		PUNTERIAS	CARTER	
			EXHAUST		VALVE COVER	OIL PAN	
			N/A		VS-3710	OS-1710	
			N/A				
DISTRIBUCIÓN		RETÉN CIGÜEÑAL		SELLOS DE VALVULA		JUNTAS VARIAS	
TIMING COVER		CRANK SEAL		STEM SEALS		MISCELLANEOUS	
TC-6710		BS-7710		SS-8710			

4.2L	MOTOR	MODELOS	DESDE / A	JUNTA DE CABEZA		MÚLTIPLE DE ADMISIÓN O PLENO	
ENGINE	MODELS	FROM / TO	HEAD GASKET		INTAKE		
L6 OHV 12V 258"	EAGLE, WRANGLER, CJ7, J10	1986/1988	CA-710-G		MS-4711		
FS-710-1							
			MÚLTIPLE DE ESCAPE		PUNTERIAS	CARTER	
			EXHAUST		VALVE COVER	OIL PAN	
			** N/A **		VS-3711	OS-1710	
			N/A				
DISTRIBUCIÓN		RETÉN CIGÜEÑAL		SELLOS DE VALVULA		JUNTAS VARIAS	
TIMING COVER		CRANK SEAL		STEM SEALS		MISCELLANEOUS	
TC-6710		BS-7710		SS-8710			







4.2L	MOTOR	MODELOS	DESDE / A	JUNTA DE CABEZA	MULTIPLE DE ADMISIÓN O PLENO
ENGINE	MODELS	FROM / TO	HEAD GASKET	INTAKE	
L6 OHV 12V 258"	EAGLE, GRAND WAGONEER, WRANGLER	1985/1989	CA-710-G	MS-4711	
FS-710-2			MULTIPLE DE ESCAPE	PUNTERIAS	CARTER
			EXHAUST	VALVE COVER	OIL PAN
			N/A	VS-3715	OS-1710
			N/A		
DISTRIBUCIÓN	RETÉN CIGÜEÑAL		SELLOS DE VALVULA	JUNTAS VARIAS	
TIMING COVER	CRANK SEAL		STEM SEALS	MISCELLANEOUS	
TC-6710	BS-7710		SS-8710		

4.6L	MOTOR	MODELOS	DESDE / A	JUNTA DE CABEZA	MULTIPLE DE ADMISIÓN O PLENO
ENGINE	MODELS	FROM / TO	HEAD GASKET	INTAKE	
L6 OHV 12V 282"	EAGLE, RAMBLER AMERICAN, PACER, WAGONEER, JAVELIN	1965/1987	CA-710-G	MS-4711	
FS-710			MULTIPLE DE ESCAPE	PUNTERIAS	CARTER
			EXHAUST	VALVE COVER	OIL PAN
			N/A	VS-3710	OS-1710
			N/A		
DISTRIBUCIÓN	RETÉN CIGÜEÑAL		SELLOS DE VALVULA	JUNTAS VARIAS	
TIMING COVER	CRANK SEAL		STEM SEALS	MISCELLANEOUS	
TC-6710	BS-7710		SS-8710		

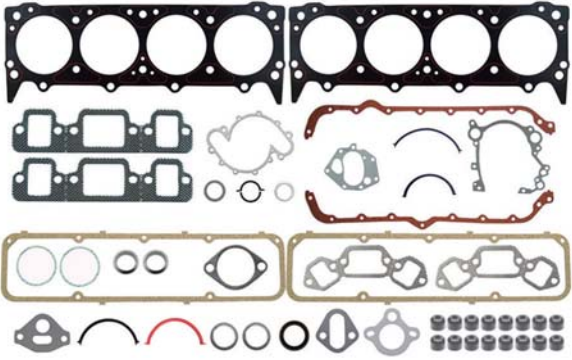

5.9L	MOTOR	MODELOS	DESDE / A	JUNTA DE CABEZA	MULTIPLE DE ADMISIÓN O PLENO
ENGINE	MODELS	FROM / TO	HEAD GASKET	INTAKE	
V8 OHV 16V 360"	AMBASSADOR, JAVELIN, MATADOR, CHEROKEE, WAGONEER, GRAND WAGONNER	1971/1991	<p>CA-718-G</p> 		
<p>FS-718</p> 				<p>MULTIPLE DE ESCAPE</p> <p>EXHAUST</p>	<p>PUNTERIAS</p> <p>VALVE COVER</p>
					<p>CARTER</p> <p>OIL PAN</p> <p>OS-1718</p> 
<p>DISTRIBUCIÓN</p> <p>TIMING COVER</p>		<p>RETÉN CIGÜEÑAL</p> <p>CRANK SEAL</p> <p>BS-7718</p> 	<p>SELLOS DE VALVULA</p> <p>STEM SEALS</p>	<p>JUNTAS VARIAS</p> <p>MISCELLANEOUS</p>	



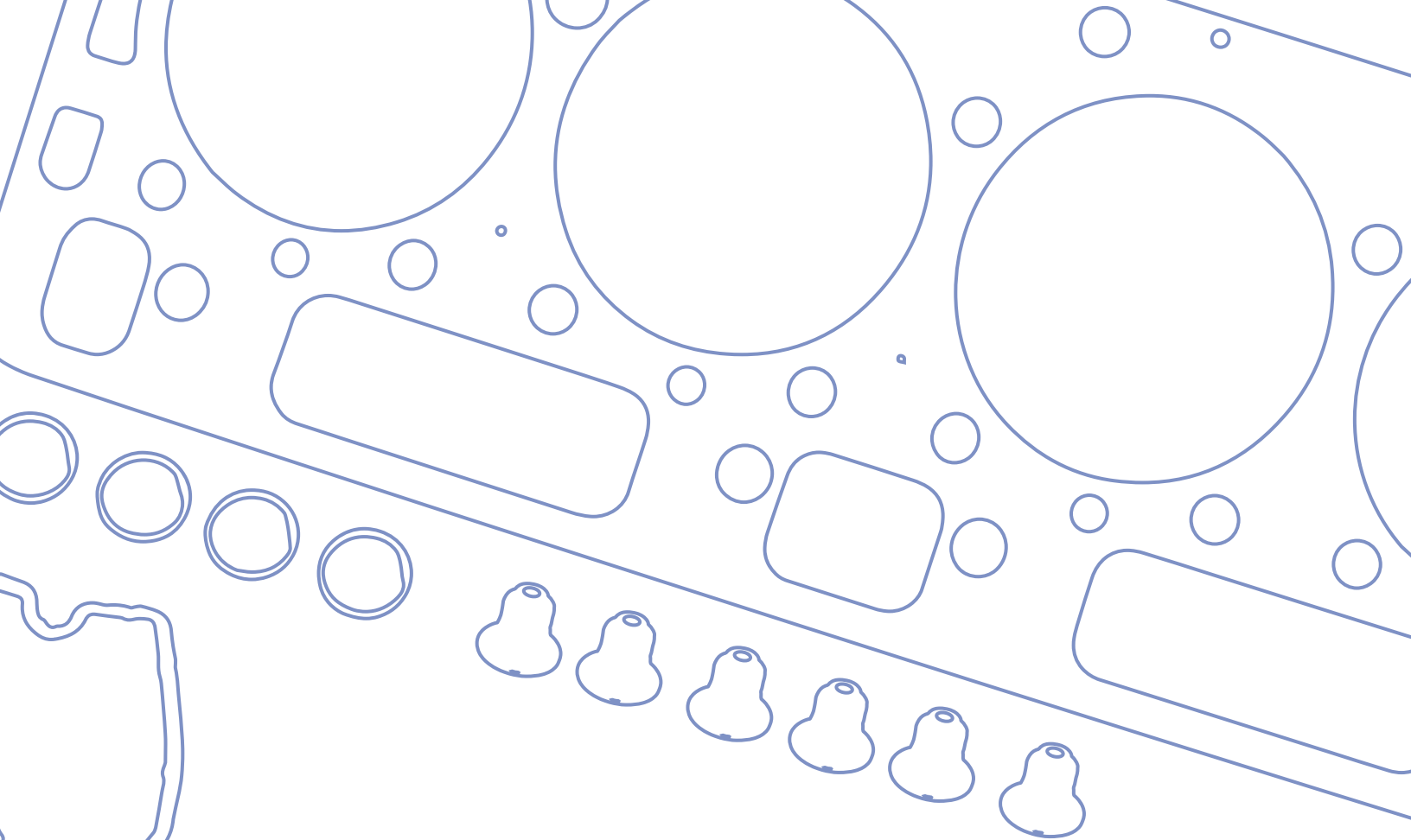

**— ■ CHRYSLER DODGE**

**MARCA  
/MAKE**

CATÁLOGO DE APLICACIONES / APPLICATION CATALOG

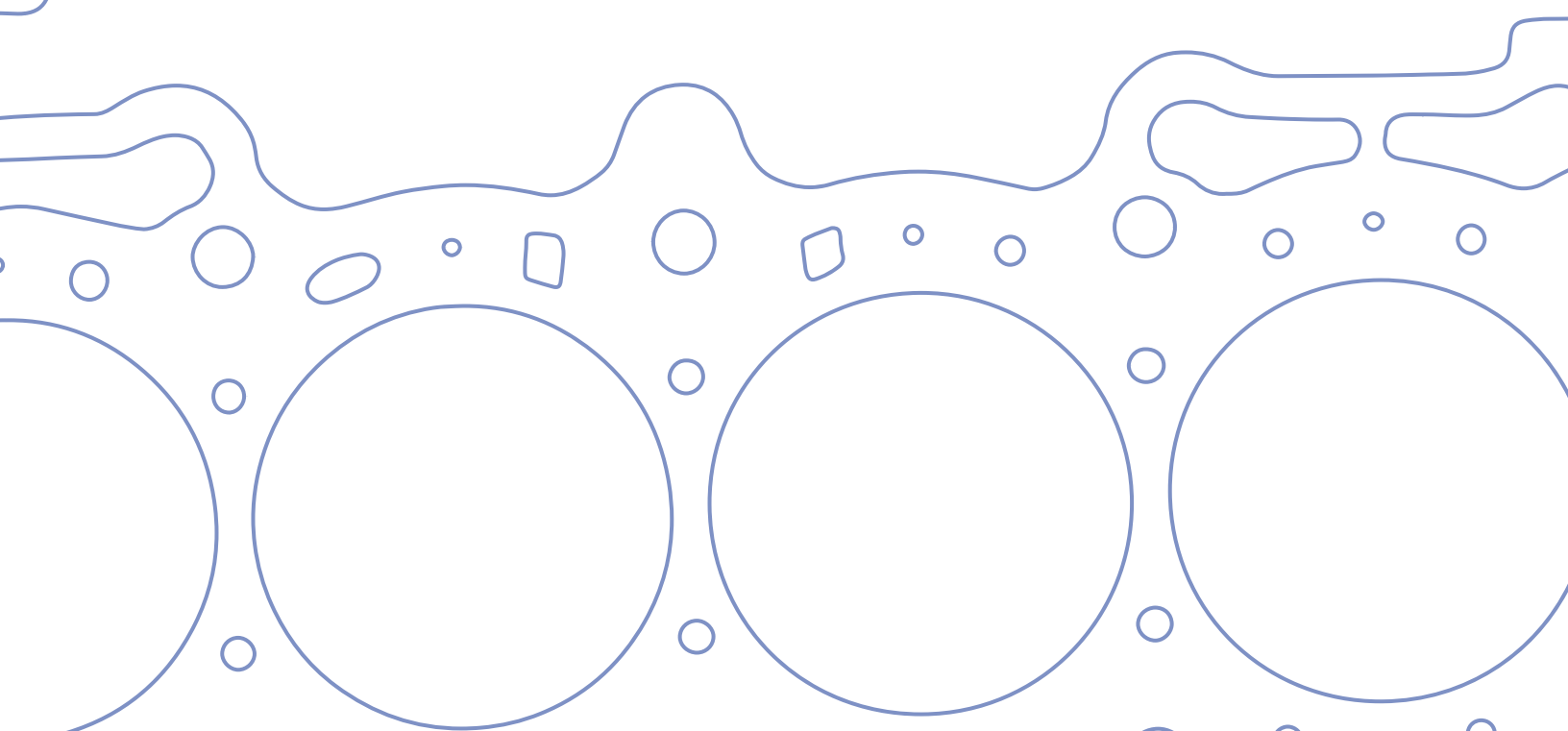







LITROS	MODELO	AÑO	PÁGINA
LITERS	MODEL	YEAR	PAGE
1.0L	ATOS	2000/2003	19
1.1L	ATOS	2004/2009	19
1.2L	i 10	2012/2014	20
1.4L	ATTITUDE	2006/2011	20
1.4L	COLT, MIRAGE, EXCEL	1979/1991	21
1.5L	VERNA	2000/2006	21
1.5L	MIRAGE	1997/2002	*
1.5L	COLT, MIRAGE, EXCEL	1979/1984	22
1.5L	COLT, MIRAGE, VISTA	1985/1990	22
1.5L	COLT, MIRAGE, VISTA	1991/1996	23
1.8L	EXPO, COLT, MIRAGE	1993/1996	*
1.8L	MIRAGE	1997/2002	*
1.8L	ELANTRA, TIBURON	1998/2002	*
1.8L	ECLIPSE, TALON, COLT, LASER	1989/1994	23
2.0L	COLT, VISTA, GALANT, 2000GTX, STELLAR	1984/1990	24
2.0L	ECLIPSE, GALANT, 2000 GTX, TALON	1990/1994	24
2.0L	ECLIPSE, EAGLE TALON	1993/1999	25
2.0L	NEON, SEBRING	1995/1999	*
2.0L	NEON, STRATUS, BREEZE	1996/2000	*
2.0L	NEON	1996/1999	25
2.0L	NEON, CIRRUS, STRATUS	1999/2005	26
2.2L	VOYAGER, DART K, SHADOW, SPIRIT, DAYTONA, LeBARON	1981/1988	26
2.2L	SHADOW, DART K, LeBARON, TOWN & COUNTRY, LANCER	1983/1990	27
2.2L	SHADOW, VOYAGER, SPIRIT, DAKOTA, PHANTOM, LeBARON	1990/1995	27
2.4L	H-100	2003/2005	28
2.4L	PATRIOT, JOURNEY, COMPASS, CALIBER, AVENGER (CABEZA EN GRAFITO)	2007/2013	28
2.4L	PATRIOT, JOURNEY, COMPASS, CALIBER, AVENGER (CABEZA EN MLS)	2007/2013	29
2.4L	PT CRUISER	2001	*
2.4L	STRATUS, CIRRUS, VOYAGER, SEBRING	1995/2000	29
2.4L	PT CRUISER (CABEZA EN MLS)	2002/2007	30
2.4L	PT CRUISER (CABEZA EN GRAFITO)	2002/2007	30
2.4L	ECLIPSE, GALANT, OUTLANDER, LANCER	2005/2009	31
2.4L	ECLIPSE, GALANT, SEBRING	2001/2005	*
2.5L	H-100	2005/2009	31
2.5L	VOYAGER, DART K, SHADOW, SPIRIT, DAYTONA, LeBARON	1981/1988	32
2.5L	SHADOW, DART K, LeBARON, TOWN & COUNTRY, LANCER	1983/1990	32
2.5L	SHADOW, VOYAGER, SPIRIT, DAKOTA, PHANTOM, LeBARON	1990/1995	33
2.5L	STRATUS, CIRRUS, SEBRING	1995/2000	33
2.6L	CARAVAN, VOYAGER, LeBARON, RAM 50	1981/1989	34
2.7L	INTREPID, CONCORDE	1998/2000	34
2.7L	INTREPID, CONCORDE, SEBRING, CIRRUS	2001/2010	35
2.8L	DART, LANCER, BARRACUDA	1960/1984	*
3.0L	CARAVAN, VOYAGER, LeBARON, DYNASTY	1987/1995	35
3.0L	GRAND CARAVAN, SHADOW, SPIRIT, GRAND VOYAGER, LeBARON.	1987/1995	36



LITROS LITERS	MODELO MODEL	AÑO YEAR	PÁGINA PAGE
3.0L	MONACO, EAGLE PREMIER	1990/1992	36
3.2L	RAM CHARGER, CHALLENGER, CHARGER, CORONET, BARRACUDA, AUTOS Y CAMIONES TODOS	1960/1984	*
3.2L	INTREPID, CONCORDE	1998/2001	*
3.3L	GRAND CARAVAN, GRAND VOYAGER	1990/2000	37
3.3L	TOWN & COUNTRY, CARAVAN, VOYAGER	2001/2010	*
3.5L	CONCORDE, INTREPID (CABEZAS DE MLS)	1993/1997	*
3.5L	INTREPID, CONCORDE, NEW YORKER	1993/1997	37
3.5L	JOURNEY, AVENGER, SEBRING, CHARGER, CHALLENGER	2007/2010	38
3.6L	CORONET, CUSTOM, DELUXE	1952/1960	*
3.6L	TOWN & COUNTRY, CARAVAN, AVENGER, JOURNEY, CHALLENGER, RAM 1500, 200	2011/2013	38
3.7L	DART, RAM CHARGER, CHALLENGER, CHARGER, CORONET, BARRACUDA, AUTOS Y CAMIONES TODOS.	1960/1984	*
3.7L	D-150, D-250, B150, B250	1981/1991	39
3.7L	DAKOTA, RAM 1500, JEEP LIBERTY (CABEZA EN GRAFITO)	2002/2005	39
3.7L	DAKOTA, RAM 1500, JEEP LIBERTY (CABEZA EN MLS)	2002/2005	40
3.7L	DAKOTA, RAM 1500, NITRO	2006/2012	40
3.8L	CORONET, CUSTOM, DELUXE	1952/1960	*
3.8L	TOWN & COUNTRY, GRAND CARAVAN, GRAND VOYAGER (CARTER Y PUNTERIAS DE SILICON).	1998/2000	41
3.8L	TOWN & COUNTRY, GRAND CARAVAN, PACIFICA	2002/2008	*
3.8L	TOWN & COUNTRY, CARAVAN, VOYAGER (CARTER Y PUNTERIAS DE CORCHO).	1994/2001	41
3.9L	DAKOTA AMERICANAS, B150, B250	1987/1989	42
3.9L	RAM VAN, W150, D150, D250	1990/1991	42
3.9L	DAKOTA, RAM 1500, RAM VAN	1992/2001	43
4.1L	NEWPORT, TOWN & COUNTRY, WINDSOR	1954/1960	*
4.3L	NEWPORT, TOWN & COUNTRY, WINDSOR	1954/1960	*
4.5L	VALIANT, DART, CHARGER, BARRACUDA, MONACO, CORONET	1964/1969	*
4.7L	RAM 1500, 2500, GRAND CHEROKEE, DURANGO, DAKOTA (CABEZA EN GRAFITO)	1999/2005	43
4.7L	RAM 1500, 2500, GRAND CHEROKEE, DURANGO, DAKOTA (CABEZA EN MLS)	1999/2005	44
5.2L	CORONET, CHARGER, SERIES D100, D200, D300	1959/1966	*
5.2L	VALIANT, DART, CHARGER, BARRACUDA, MONACO, CORONET	1964/1969	*
5.2L	CORONET, CHALLENGER, CHARGER, BARRACUDA	1967/1978	*
5.2L	B150, B250, B350, W150, W250, RAMCHARGER, DAKOTA	1989/1992	44
5.2L	RAM 1500, 2500, 3500, DURANGO, GRAND CHEROKEE, B1500, 2500, 3500.	1992/2002	45
5.7L	300 C, CHALLENGER, CHARGER	2005/2012	45
5.7L	RAM 1500, 2500, 3500, DURANGO, GRAND CHEROKEE, COMANDER	2003/2009	46
5.9L	RAM 2500, 3500 CUMMINS TURBO	2003/2008	*
5.9L	RAMCHARGER, B100, B200, B300, D100, D200, D300, CORONET, DART, MONACO	1971/1980	*

\* Escanear código QR para consultar en catálogo electrónico o diríjase a [catalogo.dcp.com.mx](http://catalogo.dcp.com.mx).



LITROS	MODELO	AÑO	PÁGINA
LITERS	MODEL	YEAR	PAGE
5.9L	RAMCHARGER, W150, W250, W350, D250, D350, CAMION MICRO	1981/1989	46
5.9L	RAMCHARGER, D150, D250, D350, W150, W250, W350, MICROBUS	1990/1992	47
5.9L	RAM 1500, 2500, 3500, DURANGO, DAKOTA	1993/2003	47
7.2L	CHARGER, CORONET, BARRACUDA, CHALLENGER, MONACO, CORONET, FURY	1966/1978	*
8.0L	RAM 2500, 3500, VIPER,	1992/2003	*













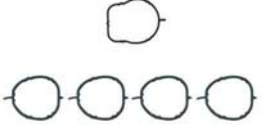
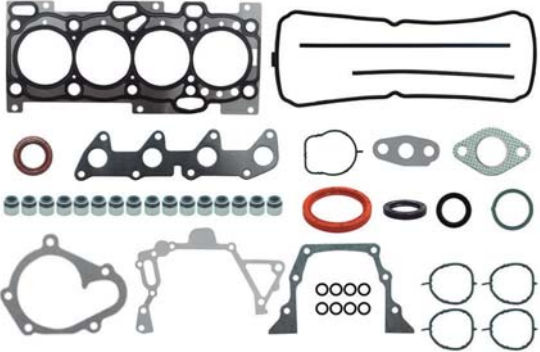





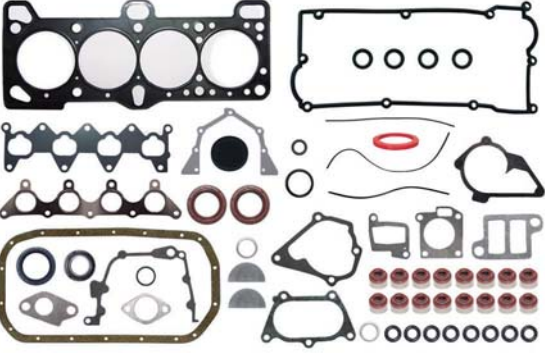

1.0L	MOTOR	MODELOS	DESDE / A	JUNTA DE CABEZA	MULTIPLE DE ADMISIÓN O PLENO
ENGINE	MODELS	FROM / TO	HEAD GASKET	INTAKE	
4L SOHC.12 V G4HC	ATOS.	2000/2003	CA-201-G 	MS-4201 	
FS-201 			MULTIPLE DE ESCAPE EXHAUST MS-4201-E 	PUNTERIAS VALVE COVER VS-3201-R 	CARTER OIL PAN OS-1201 
DISTRIBUCIÓN TIMING COVER TC-6201 	RETÉN CIGÜEÑAL CRANK SEAL BS-7201 	SELLOS DE VALVULA STEM SEALS SS-8201-PA 	MISCELLANEOUS		

1.1L	MOTOR	MODELOS	DESDE / A	JUNTA DE CABEZA	MULTIPLE DE ADMISIÓN O PLENO
ENGINE	MODELS	FROM / TO	HEAD GASKET	INTAKE	
4L SOHC 12 V G4HC	ATOS.	2004/2009	CA-201-1G 	MS-4201 	
FS-201-1 			MULTIPLE DE ESCAPE EXHAUST MS-4201-E 	PUNTERIAS VALVE COVER VS-3201-1R 	CARTER OIL PAN OS-1201 
DISTRIBUCIÓN TIMING COVER TC-6201 	RETÉN CIGÜEÑAL CRANK SEAL BS-7201 	SELLOS DE VALVULA STEM SEALS SS-8201-PA 	JUNTAS VARIAS MISCELLANEOUS		

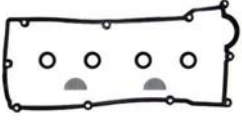

1.2L	MOTOR	MODELOS	DESDE / A	JUNTA DE CABEZA		MÚLTIPLE DE ADMISIÓN O PLENO
ENGINE	MODELS	FROM / TO	HEAD GASKET		INTAKE	
4L, SOHC 12V	i 10.	2012/2014	CA-207-ML 		MS-4207-A 	
FS-207-ML 			MÚLTIPLE DE ESCAPE	PUNTERIAS	CARTER	
			EXHAUST	VALVE COVER	OIL PAN	
			MS-4201-E 	VS-3207-R 	N/A	
DISTRIBUCIÓN	RETÉN CIGÜEÑAL	SELLOS DE VALVULA	JUNTAS VARIAS	N/A		
TIMING COVER	CRANK SEAL	STEM SEALS	MISCELLANEOUS			
TC-6201 	BS-7201 	SS-8201-PA 	N/A			

1.4L	MOTOR	MODELOS	DESDE / A	JUNTA DE CABEZA		MÚLTIPLE DE ADMISIÓN O PLENO
ENGINE	MODELS	FROM / TO	HEAD GASKET		INTAKE	
4L, DOHC 16V G4EE G4KF	ATTITUDE.	2006/2011	CA-204-ML 		MS-4204 	
FS-204-ML 			MÚLTIPLE DE ESCAPE	PUNTERIAS	CARTER	
			EXHAUST	VALVE COVER	OIL PAN	
			MS-4203-E 	VS-3204-R 	OS-1203 	
DISTRIBUCIÓN	RETÉN CIGÜEÑAL	SELLOS DE VALVULA	JUNTAS VARIAS	N/A		
TIMING COVER	CRANK SEAL	STEM SEALS	MISCELLANEOUS			
TC-6204 	BS-7203 	SS-8252-1V 	N/A			



















1.4L	MOTOR	MODELOS	DESDE / A	JUNTA DE CABEZA	MULTIPLE DE ADMISIÓN O PLENO
ENGINE	MODELS	FROM / TO	HEAD GASKET	INTAKE	
4L, SOHC 8V MOTOR MIT-SUBISHI G15B	COLT, MIRAGE, EXCEL.	1979/1991	CA-230-G 	MS-4230 	
FS-230 			MULTIPLE DE ESCAPE EXHAUST MS-4230-E 	PUNTERIAS VALVE COVER VS-3230-R 	CARTER OIL PAN OS-1230 
DISTRIBUCIÓN TIMING COVER TC-6230 	RETÉN CIGÜEÑAL CRANK SEAL BS-7230 	SELLOS DE VALVULA STEM SEALS SS-8230-PA 	JUNTAS VARIAS MISCELLANEOUS N/A	N/A	

1.5L	MOTOR	MODELOS	DESDE / A	JUNTA DE CABEZA	MULTIPLE DE ADMISIÓN O PLENO
ENGINE	MODELS	FROM / TO	HEAD GASKET	INTAKE	
4L, SOHC 12V G4EK	VERNA.	2000/2006	CA-203-ML 	MS-4203 	
FS-203-ML 			MULTIPLE DE ESCAPE EXHAUST MS-4203-1E 	PUNTERIAS VALVE COVER VS-3203-R 	CARTER OIL PAN OS-1203 
DISTRIBUCIÓN TIMING COVER TC-6203-1 	RETÉN CIGÜEÑAL CRANK SEAL BS-7203 	SELLOS DE VALVULA STEM SEALS SS-8203-V (pendiente componente)	JUNTAS VARIAS MISCELLANEOUS		





1.5L	MOTOR	MODELOS	DESDE / A	JUNTA DE CABEZA		MÚLTIPLE DE ADMISIÓN O PLENO
ENGINE	MODELS	FROM / TO	HEAD GASKET		INTAKE	
4L, SOHC 8V MOTOR MIT-SUBISHI G15B	COLT, MIRAGE, EXCEL.	1979/1984	<b>CA-230-G</b> 		<b>MS-4230</b> 	
<b>FS-230</b>			<b>MÚLTIPLE DE ESCAPE</b> <b>EXHAUST</b> <b>MS-4230-E</b> 		<b>PUNTERIAS</b> <b>VALVE COVER</b> <b>VS-3230-R</b> 	<b>CARTER</b> <b>OIL PAN</b> <b>OS-1230</b> 
<b>DISTRIBUCIÓN</b> TIMING COVER		<b>RETÉN CIGÜEÑAL</b> CRANK SEAL		<b>SELLOS DE VALVULA</b> STEM SEALS	<b>JUNTAS VARIAS</b> MISCELLANEOUS	N/A
<b>TC-6230</b> 		<b>BS-7230</b> 		<b>SS-8230-PA</b> 	N/A	

1.5L	MOTOR	MODELOS	DESDE / A	JUNTA DE CABEZA		MÚLTIPLE DE ADMISIÓN O PLENO
ENGINE	MODELS	FROM / TO	HEAD GASKET		INTAKE	
4L, SOHC 12V	COLT, MIRAGE, VISTA	1985/1990	<b>CA-230-G</b> 		<b>MS-4230-1</b> 	
<b>FS-230-1</b>			<b>MÚLTIPLE DE ESCAPE</b> <b>EXHAUST</b> <b>MS-4230-E</b> 		<b>PUNTERIAS</b> <b>VALVE COVER</b> <b>VS-3230-R</b> 	<b>CARTER</b> <b>OIL PAN</b> <b>OS-1230</b> 
<b>DISTRIBUCIÓN</b> TIMING COVER		<b>RETÉN CIGÜEÑAL</b> CRANK SEAL		<b>SELLOS DE VALVULA</b> STEM SEALS	<b>JUNTAS VARIAS</b> MISCELLANEOUS	
<b>TC-6230</b> 		<b>BS-7230</b> 		<b>SS-8230-PA</b> 		



1.5L	MOTOR	MODELOS	DESDE / A	JUNTA DE CABEZA		MÚLTIPLE DE ADMISIÓN O PLENO
ENGINE	MODELS	FROM / TO	HEAD GASKET		INTAKE	
4L, SOHC 12V MOTOR MITSUBISHI G15B	COLT, MIRAGE, VISTA	1991/1996	CA-230-G		MS-4230-2	
<b>FS-230-2</b>			<b>MÚLTIPLE DE ESCAPE</b> EXHAUST MS-4230-1E		<b>PUNTERIAS</b> VALVE COVER VS-3230-1R	<b>CARTER</b> OIL PAN OS-1230
<b>DISTRIBUCIÓN</b> TIMING COVER TC-6230		<b>RETÉN CIGÜEÑAL</b> CRANK SEAL BS-7230		<b>SELLOS DE VALVULA</b> STEM SEALS SS-8230-PA		<b>JUNTAS VARIAS</b> MISCELLANEOUS N/A

1.8L	MOTOR	MODELOS	DESDE / A	JUNTA DE CABEZA		MÚLTIPLE DE ADMISIÓN O PLENO
ENGINE	MODELS	FROM / TO	HEAD GASKET		INTAKE	
4L, SOHC 8V MOTOR MITSUBISHI 4G37 VIN T	ECLIPSE, TALON, COLT, LASER.	1989/1994	CA-237-G		MS-4231	
<b>FS-237</b>			<b>MÚLTIPLE DE ESCAPE</b> EXHAUST MS-4237-1E		<b>PUNTERIAS</b> VALVE COVER VS-3232-R	<b>CARTER</b> OIL PAN ** N/A **
<b>DISTRIBUCIÓN</b> TIMING COVER TC-6237-1		<b>RETÉN CIGÜEÑAL</b> CRANK SEAL BS-7237		<b>SELLOS DE VALVULA</b> STEM SEALS SS-8250-V		<b>JUNTAS VARIAS</b> MISCELLANEOUS N/A



2.0L	MOTOR	MODELOS	DESDE / A	JUNTA DE CABEZA		MÚLTIPLE DE ADMISIÓN O PLENO
ENGINE	MODELS	FROM / TO	HEAD GASKET		INTAKE	
4L, SOHC 8V MOTOR MIT-SUBISHI G63B 4G63 VIN V	COLT, VISTA, GALANT, 2000GTX, STELLAR.	1984/1990	CA-235-G		MS-4235	
FS-235						
DISTRIBUCIÓN		RETÉN CIGÜEÑAL	SELLOS DE VALVULA	JUNTAS VARIAS	N/A	
TIMING COVER		CRANK SEAL	STEM SEALS	MISCELLANEOUS		
TC-6235	BS-7235	SS-8230-PA	N/A			

2.0L	MOTOR	MODELOS	DESDE / A	JUNTA DE CABEZA		MÚLTIPLE DE ADMISIÓN O PLENO
ENGINE	MODELS	FROM / TO	HEAD GASKET		INTAKE	
4L, DOHC 16V MOTOR MIT-SUBISHI 4G63T VIN R U	ECLIPSE, GALANT, 2000 GTX, TALON.	1990/1994	CA-235-1G		MS-4235-1	
FS-235-1						
DISTRIBUCIÓN		RETÉN CIGÜEÑAL	SELLOS DE VALVULA	JUNTAS VARIAS		
TIMING COVER		CRANK SEAL	STEM SEALS	MISCELLANEOUS		
TC-6235	BS-7250	SS-8230-PA	235.1			





2.0L	MOTOR	MODELOS	DESDE / A	JUNTA DE CABEZA	MULTIPLE DE ADMISIÓN O PLENO
ENGINE	MODELS	FROM / TO	HEAD GASKET	INTAKE	
4L, DOHC 16V MOTOR MITSUBISHI 4G63T VIN F	ECLIPSE, EAGLE TALON	1993/1999	CA-235-G 		
FS-236 			MULTIPLE DE ESCAPE EXHAUST	PUNTERIAS VALVE COVER	CARTER OIL PAN
			MS-4235-1E 	VS-3235-2R 	N/A
DISTRIBUCIÓN TIMING COVER	RETÉN CIGÜEÑAL CRANK SEAL		SELLOS DE VALVULA STEM SEALS	JUNTAS VARIAS MISCELLANEOUS	N/A
TC-6235-2 	BS-7205 		SS-8235 	N/A	

2.0L	MOTOR	MODELOS	DESDE / A	JUNTA DE CABEZA	MULTIPLE DE ADMISIÓN O PLENO
ENGINE	MODELS	FROM / TO	HEAD GASKET	INTAKE	
4L, SOHC 16V VIN C	NEON.	1996/1999	CA-242-G 	MS-4243-1 	
FS-242-1 			MULTIPLE DE ESCAPE EXHAUST	PUNTERIAS VALVE COVER	CARTER OIL PAN
			MS-4243-E 	VS-3243-1R 	OS-1242-HD 
DISTRIBUCIÓN TIMING COVER	RETÉN CIGÜEÑAL CRANK SEAL		SELLOS DE VALVULA STEM SEALS	JUNTAS VARIAS MISCELLANEOUS	
TC-6242-2 	BS-7240 		SS-8242-V 		



2.0L	MOTOR	MODELOS	DESDE / A	JUNTA DE CABEZA	MULTIPLE DE ADMISIÓN O PLENO
ENGINE	MODELS	FROM / TO	HEAD GASKET	INTAKE	
4L, SOHC 16V VIN C, F	NEON, CIRRUS, STRATUS	1999/2005	<b>CA-242-G</b> 	<b>MS-4243-1</b> 	
<b>FS-243-1</b>					
<b>DISTRIBUCIÓN</b>	<b>RETÉN CIGÜEÑAL</b>	<b>SELLOS DE VALVULA</b>	<b>JUNTAS VARIAS</b>		
<b>TIMING COVER</b>	<b>CRANK SEAL</b>	<b>STEM SEALS</b>	<b>MISCELLANEOUS</b>		
TC-6242-1	BS-7240	SS-8242-V			

2.2L	MOTOR	MODELOS	DESDE / A	JUNTA DE CABEZA	MULTIPLE DE ADMISIÓN O PLENO
ENGINE	MODELS	FROM / TO	HEAD GASKET	INTAKE	
4L, SOHC 8V VIN K C D EXCEPTO TURBO	VOYAGER, DART K, SHADOW, SPIRIT, DAYTONA, LeBARON.	1981/1988	<b>CA-240-G</b> 	<b>MS-4240</b> 	
<b>FS-240</b>					
<b>DISTRIBUCIÓN</b>	<b>RETÉN CIGÜEÑAL</b>	<b>SELLOS DE VALVULA</b>	<b>JUNTAS VARIAS</b>		
<b>TIMING COVER</b>	<b>CRANK SEAL</b>	<b>STEM SEALS</b>	<b>MISCELLANEOUS</b>		
TC-6240	BS-7240	SS-8240-S			





2.2L	MOTOR	MODELOS	DESDE / A	JUNTA DE CABEZA		MULTIPLE DE ADMISIÓN O PLENO	
ENGINE	MODELS	FROM / TO	HEAD GASKET		INTAKE		
4L, SOHC 8V MOTOR TURBO	SHADOW, DART K, LeBARON, TOWN & COUNTRY, LANCER	1983/1990	CA-240-G		MS-4240		
FS-240-1			MULTIPLE DE ESCAPE		PUNTERIAS	CARTER	
			EXHAUST		VALVE COVER	OIL PAN	
			** N/A **		VS-3240-1	OS-1240-1C	
			N/A				
DISTRIBUCIÓN		RETÉN CIGÜEÑAL		SELLOS DE VALVULA		JUNTAS VARIAS	
TIMING COVER		CRANK SEAL		STEM SEALS		MISCELLANEOUS	
TC-6240-1		BS-7240		SS-8240-S			

2.2L	MOTOR	MODELOS	DESDE / A	JUNTA DE CABEZA		MULTIPLE DE ADMISIÓN O PLENO	
ENGINE	MODELS	FROM / TO	HEAD GASKET		INTAKE		
4L, SOHC 8V MOTOR TURBO CARTER Y PUNTERIA SILICON	SHADOW, VOYAGER, SPIRIT, DAKOTA, PHANTOM, LeBARON	1990/1995	CA-240-G		MS-4240		
FS-240-2			MULTIPLE DE ESCAPE		PUNTERIAS	CARTER	
			EXHAUST		VALVE COVER	OIL PAN	
			** N/A **		VS-3240-2R	OS-1240-1R	
			N/A				
DISTRIBUCIÓN		RETÉN CIGÜEÑAL		SELLOS DE VALVULA		JUNTAS VARIAS	
TIMING COVER		CRANK SEAL		STEM SEALS		MISCELLANEOUS	
TC-6240-2		BS-7240		SS-8240-S			



2.4L	MOTOR	MODELOS	DESDE / A	JUNTA DE CABEZA	MULTIPLE DE ADMISIÓN O PLENO
ENGINE	MODELS	FROM / TO	HEAD GASKET	INTAKE	
4L, SOHC 8V G64B 464B	H-100.	2003/2005	CA-202-G 	MS-4235 	
FS-202 			MULTIPLE DE ESCAPE EXHAUST	PUNTERIAS VALVE COVER	CARTER OIL PAN
DISTRIBUCIÓN TIMING COVER			SELLOS DE VALVULA STEM SEALS	JUNTAS VARIAS MISCELLANEOUS	
TC-6235 	RETÉN CIGÜEÑAL CRANK SEAL	SS-8250-N 	OS-1235 		
	BS-7250 				

2.4L	MOTOR	MODELOS	DESDE / A	JUNTA DE CABEZA	MULTIPLE DE ADMISIÓN O PLENO
ENGINE	MODELS	FROM / TO	HEAD GASKET	INTAKE	
4L, DOHC 16V MOTOR GEMA VIN W, K	PATRIOT, JOURNEY, COMPASS, CALIBER, AVENGER (CABEZA EN GRÁFITO).	2007/2013	CA-226-G 	MS-4226-A 	
FS-226-G 			MULTIPLE DE ESCAPE EXHAUST	PUNTERIAS VALVE COVER	CARTER OIL PAN
DISTRIBUCIÓN TIMING COVER			SELLOS DE VALVULA STEM SEALS	JUNTAS VARIAS MISCELLANEOUS	
TC-6226 	RETÉN CIGÜEÑAL CRANK SEAL	SS-8226-V 	N/A		
	BS-7226 				











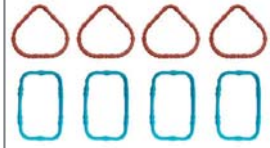
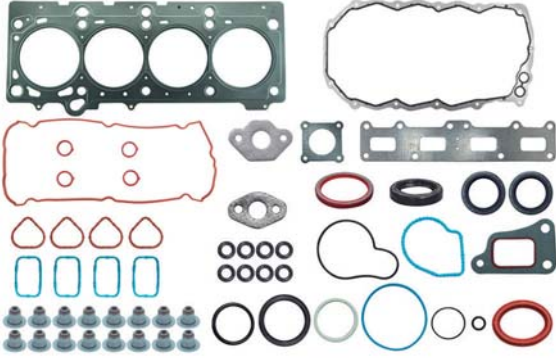

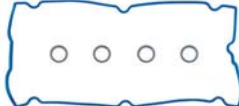

2.4L	MOTOR	MODELOS	DESDE / A	JUNTA DE CABEZA	MULTIPLE DE ADMISIÓN O PLENO
ENGINE	MODELS	FROM / TO	HEAD GASKET	INTAKE	
4L, DOHC 16V MOTOR GEMA VIN W, B	PATRIOT, JOURNEY, COMPASS, CALIBER, AVENGER (CABEZA EN MLS).	2007/2013	CA-226-ML 	MS-4226-A 	
FS-226-ML 			MULTIPLE DE ESCAPE EXHAUST	PUNTERIAS VALVE COVER	CARTER OIL PAN
			MS-4226-E 	VS-3226-R 	
DISTRIBUCIÓN TIMING COVER		RETÉN CIGÜEÑAL CRANK SEAL		SELLOS DE VALVULA STEM SEALS	JUNTAS VARIAS MISCELLANEOUS
TC-6226		BS-7226		SS-8226-V 	N/A

2.4L	MOTOR	MODELOS	DESDE / A	JUNTA DE CABEZA	MULTIPLE DE ADMISIÓN O PLENO
ENGINE	MODELS	FROM / TO	HEAD GASKET	INTAKE	
4L, DOHC 16V VIN X, B	STRATUS, CIRRUS, VOYAGER, SEBRING.	1995/2000	CA-245-G 	MS-4242 	
FS-245 			MULTIPLE DE ESCAPE EXHAUST	PUNTERIAS VALVE COVER	CARTER OIL PAN
			MS-4242-E 	VS-3242-1R 	OS-1245-HD 
DISTRIBUCIÓN TIMING COVER		RETÉN CIGÜEÑAL CRANK SEAL		SELLOS DE VALVULA STEM SEALS	JUNTAS VARIAS MISCELLANEOUS
TC-6242-1		BS-7240		SS-8242-V 	N/A

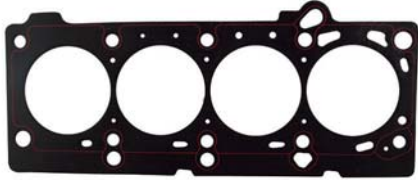
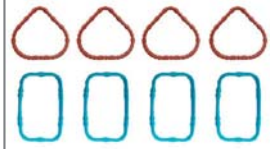
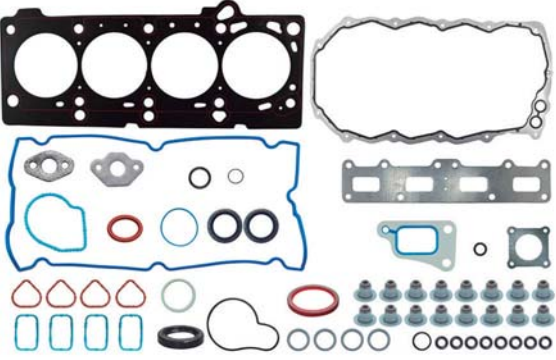

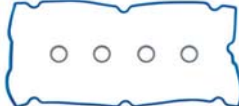

2.4L	MOTOR	MODELOS	DESDE / A	JUNTA DE CABEZA	MULTIPLE DE ADMISIÓN O PLENO
ENGINE	MODELS	FROM / TO	HEAD GASKET	INTAKE	
4L, DOHC 16V VIN X, B	PT CRUISER (CABEZA EN MLS).	2002/2007	<b>CA-245-1ML</b> 	<b>MS-4245-1</b> 	
<b>FS-245-1ML</b> 			<b>MULTIPLE DE ESCAPE</b> <b>EXHAUST</b> <b>MS-4245-1E</b> 	<b>PUNTERIAS</b> <b>VALVE COVER</b> <b>VS-3245-R</b> 	<b>CARTER</b> <b>OIL PAN</b> <b>OS-1245-2</b> 
<b>DISTRIBUCIÓN</b> <b>TIMING COVER</b> <b>TC-6242-1</b> 	<b>RETÉN CIGÜEÑAL</b> <b>CRANK SEAL</b> <b>BS-7240</b> 	<b>SELLOS DE VALVULA</b> <b>STEM SEALS</b> <b>SS-8242-V</b> 	<b>JUNTAS VARIAS</b> <b>MISCELLANEOUS</b> <b>N/A</b>		

2.4L	MOTOR	MODELOS	DESDE / A	JUNTA DE CABEZA	MULTIPLE DE ADMISIÓN O PLENO
ENGINE	MODELS	FROM / TO	HEAD GASKET	INTAKE	
4L, DOHC 16V VIN X, B	PT CRUISER (CABEZA EN GRAFITO).	2002/2007	<b>CA-245-1G</b> 	<b>MS-4245-1</b> 	
<b>FS-245-1</b> 			<b>MULTIPLE DE ESCAPE</b> <b>EXHAUST</b> <b>MS-4245-1E</b> 	<b>PUNTERIAS</b> <b>VALVE COVER</b> <b>VS-3245-R</b> 	<b>CARTER</b> <b>OIL PAN</b> <b>OS-1245-2</b> 
<b>DISTRIBUCIÓN</b> <b>TIMING COVER</b> <b>TC-6242-1</b> 	<b>RETÉN CIGÜEÑAL</b> <b>CRANK SEAL</b> <b>BS-7240</b> 	<b>SELLOS DE VALVULA</b> <b>STEM SEALS</b> <b>SS-8242-V</b> 	<b>JUNTAS VARIAS</b> <b>MISCELLANEOUS</b> <b>N/A</b>		



2.4L	MOTOR	MODELOS	DESDE / A	JUNTA DE CABEZA	MULTIPLE DE ADMISIÓN O PLENO
ENGINE	MODELS	FROM / TO	HEAD GASKET	INTAKE	
4L, SOHC 16V MOTOR MITSUBISHI 4G69	ECLIPSE, GALANT, OUTLANDER, LANCER.	2005/2009	CA-247-ML 	MS-4247-A 	
FS-247-ML 			MULTIPLE DE ESCAPE EXHAUST	PUNTERIAS VALVE COVER VS-3247-R 	CARTER OIL PAN OS-1251-1 
DISTRIBUCIÓN TIMING COVER TC-6247 	RETÉN CIGÜEÑAL CRANK SEAL BS-7226 	SELLOS DE VALVULA STEM SEALS SS-8109-S 	JUNTAS VARIAS MISCELLANEOUS N/A	N/A	

2.5L	MOTOR	MODELOS	DESDE / A	JUNTA DE CABEZA	MULTIPLE DE ADMISIÓN O PLENO
ENGINE	MODELS	FROM / TO	HEAD GASKET	INTAKE	
4L, SOHC 8V TDI MOTOR MITSUBISHI 4D56T	H-100.	2005/2009	CA-206-D 	MS-4206-D 	
FS-206-D 			MULTIPLE DE ESCAPE EXHAUST ** N/A **	PUNTERIAS VALVE COVER VS-3206-RD 	CARTER OIL PAN OS-1250 
DISTRIBUCIÓN TIMING COVER TC-6206-D 	RETÉN CIGÜEÑAL CRANK SEAL BS-7206-D 	SELLOS DE VALVULA STEM SEALS SS-8250-N 	JUNTAS VARIAS MISCELLANEOUS N/A	N/A	





2.5L	MOTOR	MODELOS	DESDE / A	JUNTA DE CABEZA		MÚLTIPLE DE ADMISIÓN O PLENO
ENGINE	MODELS	FROM / TO	HEAD GASKET		INTAKE	
4L, SOHC 8V VIN K C D EXCEPTO TURBO	VOYAGER, DART K, SHADOW, SPIRIT, DAYTONA, LeBARON.	1981/1988	CA-240-G		MS-4240	
FS-240			MÚLTIPLE DE ESCAPE		PUNTERIAS	CARTER
			EXHAUST		VALVE COVER	OIL PAN
			** N/A **		VS-3240	OS-1240
			N/A			
DISTRIBUCIÓN	RETÉN CIGÜEÑAL	SELLOS DE VALVULA	JUNTAS VARIAS			
TIMING COVER	CRANK SEAL	STEM SEALS	MISCELLANEOUS			
TC-6240	BS-7240	SS-8240-S				









2.5L	MOTOR	MODELOS	DESDE / A	JUNTA DE CABEZA		MÚLTIPLE DE ADMISIÓN O PLENO
ENGINE	MODELS	FROM / TO	HEAD GASKET		INTAKE	
4L, SOHC 8V MOTOR TURBO	SHADOW, DART K, LeBARON, TOWN & COUNTRY, LANCER	1983/1990	CA-240-G		MS-4240	
FS-240-1			MÚLTIPLE DE ESCAPE		PUNTERIAS	CARTER
			EXHAUST		VALVE COVER	OIL PAN
			** N/A **		VS-3240-1	OS-1240-1C
			N/A			
DISTRIBUCIÓN	RETÉN CIGÜEÑAL	SELLOS DE VALVULA	JUNTAS VARIAS			
TIMING COVER	CRANK SEAL	STEM SEALS	MISCELLANEOUS			
TC-6240-1	BS-7240	SS-8240-S				

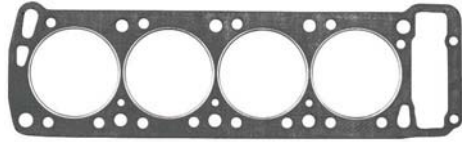



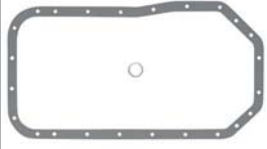

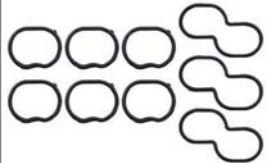
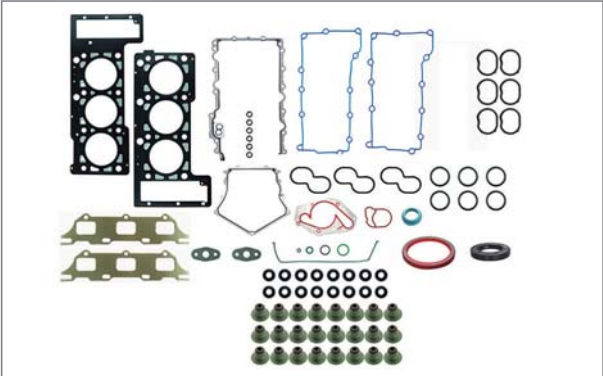

2.5L	MOTOR	MODELOS	DESDE / A	JUNTA DE CABEZA	MULTIPLE DE ADMISIÓN O PLENO
ENGINE	MODELS	FROM / TO	HEAD GASKET	INTAKE	
4L, SOHC 8V MOTOR TURBO CARTER Y PUNTERIA SILICON	SHADOW, VOYAGER, SPIRIT, DAKOTA, PHANTOM, LeBARON	1990/1995	CA-240-G 	MS-4240 	
<b>FS-240-2</b> 			MULTIPLE DE ESCAPE EXHAUST	PUNTERIAS VALVE COVER	CARTER OIL PAN
			** N/A ** N/A	VS-3240-2R 	OS-1240-1R 
DISTRIBUCIÓN TIMING COVER		RETÉN CIGÜEÑAL CRANK SEAL		SELLOS DE VALVULA STEM SEALS	JUNTAS VARIAS MISCELLANEOUS
TC-6240-2		BS-7240		SS-8240-S 	

2.5L	MOTOR	MODELOS	DESDE / A	JUNTA DE CABEZA	MULTIPLE DE ADMISIÓN O PLENO
ENGINE	MODELS	FROM / TO	HEAD GASKET	INTAKE	
V6, SOHC 24V MOTOR MITSUBISHI 6G73 VIN H	STRATUS, CIRRUS, SEBRING (CABEZAS DE GRAFITO).	1995/2000	CA-252-G 	MS-4252 	
<b>FS-252</b> 			MULTIPLE DE ESCAPE EXHAUST	PUNTERIAS VALVE COVER	CARTER OIL PAN
			MS-4252-E 	VS-3252-R 	OS-1252 
DISTRIBUCIÓN TIMING COVER		RETÉN CIGÜEÑAL CRANK SEAL		SELLOS DE VALVULA STEM SEALS	JUNTAS VARIAS MISCELLANEOUS
TC-6252		BS-7240		SS-8252-S 	

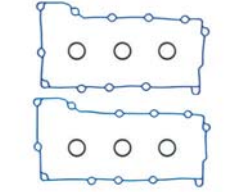
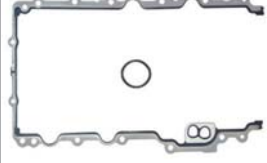

2.6L	MOTOR	MODELOS	DESDE / A	JUNTA DE CABEZA		MÚLTIPLE DE ADMISIÓN O PLENO	
ENGINE	MODELS	FROM / TO	HEAD GASKET		INTAKE		
4L, SOHC 8V MOTOR G54B VIN G, E	CARAVAN, VOYAGER, LeBARON, RAM 50.	1981/1989	<b>CA-250-G</b> 		<b>MS-4250</b> 		
<b>FS-250</b>							
							
<b>MÚLTIPLE DE ESCAPE</b>		<b>PUNTERIAS</b>		<b>CARTER</b>			
<b>EXHAUST</b>		<b>VALVE COVER</b>		<b>OIL PAN</b>			
<b>MS-4250-E</b>		<b>VS-3250-R</b>		<b>OS-1250</b>			
							
<b>DISTRIBUCIÓN</b>	<b>RETÉN CIGÜEÑAL</b>	<b>SELLOS DE VALVULA</b>	<b>JUNTAS VARIAS</b>	N/A			
<b>TIMING COVER</b>	<b>CRANK SEAL</b>	<b>STEM SEALS</b>	<b>MISCELLANEOUS</b>				
<b>TC-6250</b>		<b>BS-7250</b>					

2.7L	MOTOR	MODELOS	DESDE / A	JUNTA DE CABEZA		MÚLTIPLE DE ADMISIÓN O PLENO	
ENGINE	MODELS	FROM / TO	HEAD GASKET		INTAKE		
V6, DOHC 24V VIN R	INTREPID, CONCORDE.	1998/2000	<b>CA-280-ML Y CA-281-ML</b> <p>PARA VER IMAGEN DIRIGIRSE A SECCIÓN DE JUNTAS DE CABEZA.                      TO SEE IMAGE GO TO HEAD GASKET SECTION</p>		<b>MS-4280</b> 		
<b>FS-280</b>							
							
<b>MÚLTIPLE DE ESCAPE</b>		<b>PUNTERIAS</b>		<b>CARTER</b>			
<b>EXHAUST</b>		<b>VALVE COVER</b>		<b>OIL PAN</b>			
<b>MS-4280-E</b>		<b>VS-3280-R</b>		<b>OS-1280-R</b>			
							
<b>DISTRIBUCIÓN</b>	<b>RETÉN CIGÜEÑAL</b>	<b>SELLOS DE VALVULA</b>	<b>JUNTAS VARIAS</b>	N/A			
<b>TIMING COVER</b>	<b>CRANK SEAL</b>	<b>STEM SEALS</b>	<b>MISCELLANEOUS</b>				
<b>TC-6280</b>		<b>BS-7240</b>					









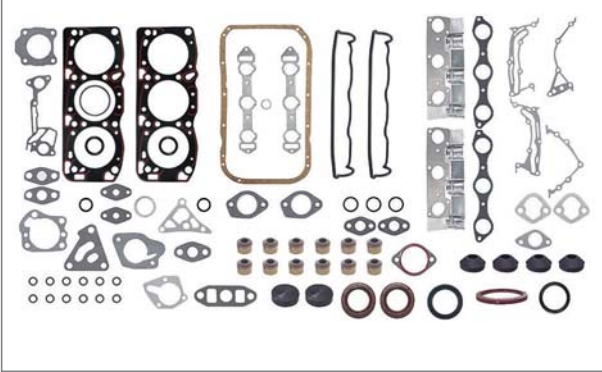

2.7L	MOTOR	MODELOS	DESDE / A	JUNTA DE CABEZA	MULTIPLE DE ADMISIÓN O PLENO
ENGINE	MODELS	FROM / TO	HEAD GASKET	INTAKE	
V6, DOHC 24V VIN R, D, T, U	INTREPID, CONCORDE, SEBRING, CIRRUS	2001/2010	CA-280-ML Y CA-281-ML	MS-4280	
<p>PARA VER IMAGEN DIRIGIRSE A SECCIÓN DE JUNTAS DE CABEZA.</p> <p>TO SEE IMAGE GO TO HEAD GASKET SECTION</p>					
<p>FS-280-1</p>			<p>MULTIPLE DE ESCAPE</p> <p>EXHAUST</p> <p>MS-4280-E</p>	<p>PUNTERIAS</p> <p>VALVE COVER</p> <p>VS-3280-1R</p>	<p>CARTER</p> <p>OIL PAN</p> <p>OS-1280-R</p>
<p>DISTRIBUCIÓN</p> <p>TIMING COVER</p> <p>TC-6280</p>	<p>RETÉN CIGÜEÑAL</p> <p>CRANK SEAL</p> <p>BS-7240</p>	<p>SELLOS DE VALVULA</p> <p>STEM SEALS</p> <p>SS-8280-V</p>	<p>JUNTAS VARIAS</p> <p>MISCELLANEOUS</p> <p>N/A</p>	N/A	

3.0L	MOTOR	MODELOS	DESDE / A	JUNTA DE CABEZA	MULTIPLE DE ADMISIÓN O PLENO
ENGINE	MODELS	FROM / TO	HEAD GASKET	INTAKE	
V6, SOHC 12V MOTOR MITSUBISHI 6G72 MULT. ESCAPE S/DEFLECTOR	CARAVAN, VOYAGER, LeBARON, DYNASTY.	1987/1995	CA-253-G	MS-4253	
<p>FS-253</p>			<p>MULTIPLE DE ESCAPE</p> <p>EXHAUST</p> <p>MS-4253-3E</p>	<p>PUNTERIAS</p> <p>VALVE COVER</p> <p>VS-3253-R</p>	<p>CARTER</p> <p>OIL PAN</p> <p>OS-1253</p>
<p>DISTRIBUCIÓN</p> <p>TIMING COVER</p> <p>TC-6253</p>	<p>RETÉN CIGÜEÑAL</p> <p>CRANK SEAL</p> <p>BS-7253</p>	<p>SELLOS DE VALVULA</p> <p>STEM SEALS</p> <p>SS-8253</p>	<p>JUNTAS VARIAS</p> <p>MISCELLANEOUS</p> <p>N/A</p>	N/A	

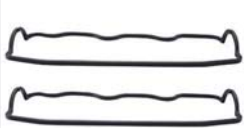

3.0L	MOTOR	MODELOS	DESDE / A	JUNTA DE CABEZA		MULTIPLE DE ADMISIÓN O PLENO
ENGINE	MODELS	FROM / TO	HEAD GASKET		INTAKE	
V6, SOHC 12V MOTOR MITSUBISHI 6G72 MULT. ESCAPE C/DEFLECTOR	GRAND CARAVAN, SHADOW, SPIRIT, GRAND VOYAGER, LeBARON,	1987/1995				
FS-253-1						
MULTIPLE DE ESCAPE		PUNTERIAS		CARTER		
EXHAUST		VALVE COVER		OIL PAN		
MS-4253-2E		VS-3253-R		OS-1253		
						
DISTRIBUCIÓN	RETÉN CIGÜEÑAL	SELLOS DE VALVULA		JUNTAS VARIAS		N/A
TIMING COVER	CRANK SEAL	STEM SEALS		MISCELLANEOUS		
TC-6253	BS-7253	SS-8253		N/A		

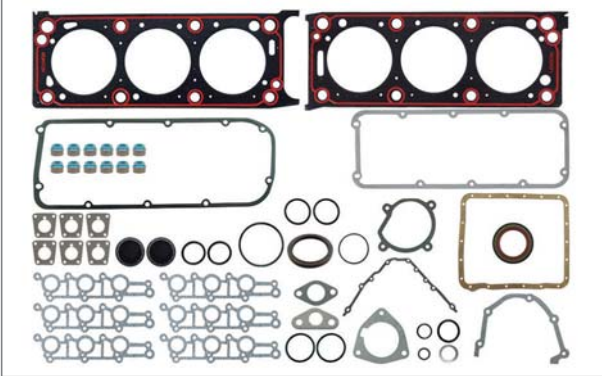
3.0L	MOTOR	MODELOS	DESDE / A	JUNTA DE CABEZA		MULTIPLE DE ADMISIÓN O PLENO
ENGINE	MODELS	FROM / TO	HEAD GASKET		INTAKE	
V6, OHV 12V VIN V	MONACO, EAGLE PREMIER	1990/1992	<p>** N/A **</p> <p>N/A</p>			
FS-285						
MULTIPLE DE ESCAPE		PUNTERIAS		CARTER		
EXHAUST		VALVE COVER		OIL PAN		
** N/A **		** N/A **				
N/A		N/A				
DISTRIBUCIÓN	RETÉN CIGÜEÑAL	SELLOS DE VALVULA		JUNTAS VARIAS		N/A
TIMING COVER	CRANK SEAL	STEM SEALS		MISCELLANEOUS		
** N/A **	** N/A **	** N/A **		N/A		





3.3L	MOTOR	MODELOS	DESDE / A	JUNTA DE CABEZA	MULTIPLE DE ADMISIÓN O PLENO
ENGINE	MODELS	FROM / TO	HEAD GASKET	INTAKE	
V6, OHV 12V NO INCLUYE CONCHA DE ADMISION	GRAND CARAVAN, GRAND VOYAGER.	1990/2000	<p>CA-254-G Y CA-255-G</p> <p>PARA VER IMAGEN DIRIGIRSE A SECCIÓN DE JUNTAS DE CABEZA.</p> <p>TO SEE IMAGE GO TO HEAD GASKET SECTION</p>	<p>MS-4254-A</p>	
<p>FS-254</p>			<p>MULTIPLE DE ESCAPE</p> <p>EXHAUST</p> <p>MS-4254-E</p>	<p>PUNTERIAS</p> <p>VALVE COVER</p> <p>VS-3254-HD</p>	<p>CARTER</p> <p>OIL PAN</p> <p>OS-1254-HD</p>
<p>DISTRIBUCIÓN</p> <p>TIMING COVER</p> <p>TC-6254</p>	<p>RETÉN CIGÜEÑAL</p> <p>CRANK SEAL</p> <p>BS-7240-1</p>	<p>SELLOS DE VALVULA</p> <p>STEM SEALS</p> <p>SS-8240-S</p>	<p>JUNTAS VARIAS</p> <p>MISCELLANEOUS</p> <p>N/A</p>	N/A	

3.5L	MOTOR	MODELOS	DESDE / A	JUNTA DE CABEZA	MULTIPLE DE ADMISIÓN O PLENO
ENGINE	MODELS	FROM / TO	HEAD GASKET	INTAKE	
V6, SOHC 24V VIN F	INTREPID, CONCORDE, NEW YORKER.	1993/1997	<p>CA-261-G</p>	<p>MS-4261</p>	
<p>FS-261</p>			<p>MULTIPLE DE ESCAPE</p> <p>EXHAUST</p> <p>MS-4262-E</p>	<p>PUNTERIAS</p> <p>VALVE COVER</p> <p>VS-3261-HD</p>	<p>CARTER</p> <p>OIL PAN</p> <p>OS-1261-R</p>
<p>DISTRIBUCIÓN</p> <p>TIMING COVER</p> <p>TC-6261</p>	<p>RETÉN CIGÜEÑAL</p> <p>CRANK SEAL</p> <p>BS-7253</p>	<p>SELLOS DE VALVULA</p> <p>STEM SEALS</p> <p>SV-8262-V</p>	<p>JUNTAS VARIAS</p> <p>MISCELLANEOUS</p> <p>N/A</p>	N/A	



3.5L	MOTOR	MODELOS	DESDE / A	JUNTA DE CABEZA	MULTIPLE DE ADMISIÓN O PLENO
ENGINE	MODELS	FROM / TO	HEAD GASKET	INTAKE	
V6, SOHC 24V	JOURNEY, AVENGER, SEBRING, CHARGER, CHALLENGER, MODELO 300.	2007/2010	<p>CA-268-ML Y CA-268-1ML</p> <p>PARA VER IMAGEN DIRIGIRSE A SECCIÓN DE JUNTAS DE CABEZA.</p> <p>TO SEE IMAGE GO TO HEAD GASKET SECTION</p>	MS-4261-3LS	
FS-268-ML					
DISTRIBUCIÓN		RETÉN CIGÜEÑAL	SELLOS DE VALVULA	JUNTAS VARIAS	N/A
TIMING COVER		CRANK SEAL	STEM SEALS	MISCELLANEOUS	
TC-6268		BS-7268-LT	SS-8268-V	N/A	

3.6L	MOTOR	MODELOS	DESDE / A	JUNTA DE CABEZA	MULTIPLE DE ADMISIÓN O PLENO
ENGINE	MODELS	FROM / TO	HEAD GASKET	INTAKE	
V6, DOHC 24V MOTOR PENTASTAR VIN G	TOWN & COUNTRY, CARAVAN, AVENGER, JOURNEY, CHALLENGER, RAM 1500, 200.	2011/2013	<p>CA-269-ML Y CA-269-1ML</p> <p>PARA VER IMAGEN DIRIGIRSE A SECCIÓN DE JUNTAS DE CABEZA.</p> <p>TO SEE IMAGE GO TO HEAD GASKET SECTION</p>	MS-4269	
FS-269-ML					
DISTRIBUCIÓN		RETÉN CIGÜEÑAL	SELLOS DE VALVULA	JUNTAS VARIAS	N/A
TIMING COVER		CRANK SEAL	STEM SEALS	MISCELLANEOUS	
				N/A	



3.7L	MOTOR	MODELOS	DESDE / A	JUNTA DE CABEZA	MULTIPLE DE ADMISIÓN O PLENO
ENGINE	MODELS	FROM / TO	HEAD GASKET	INTAKE	
L6, OHV 12V MOTOR 225"	D-150, D-250, B150, B250	1981/1991	CA-225-G	MS-4220	
<b>FS-225-1</b> 					
<b>DISTRIBUCIÓN</b>		<b>RETÉN CIGÜEÑAL</b>	<b>SELLOS DE VALVULA</b>	<b>JUNTAS VARIAS</b>	
<b>TIMING COVER</b>		<b>CRANK SEAL</b>	<b>STEM SEALS</b>	<b>MISCELLANEOUS</b>	
TC-6220		BS-7220-R	SS-8220-A		

3.7L	MOTOR	MODELOS	DESDE / A	JUNTA DE CABEZA	MULTIPLE DE ADMISIÓN O PLENO
ENGINE	MODELS	FROM / TO	HEAD GASKET	INTAKE	
V6, SOHC 12V VIN K CABEZA DE GRAFITO	DAKOTA, RAM 1500, JEEP LIBERTY (CABEZA EN GRAFITO).	2002/2005	CA-271-G	MS-4271	
<b>FS-271</b> 					
<b>DISTRIBUCIÓN</b>		<b>RETÉN CIGÜEÑAL</b>	<b>SELLOS DE VALVULA</b>	<b>JUNTAS VARIAS</b>	
<b>TIMING COVER</b>		<b>CRANK SEAL</b>	<b>STEM SEALS</b>	<b>MISCELLANEOUS</b>	
TC-6271		BS-7271	SS-8271-12V		





3.7L	MOTOR	MODELOS	DESDE / A	JUNTA DE CABEZA	MULTIPLE DE ADMISIÓN O PLENO
ENGINE	MODELS	FROM / TO	HEAD GASKET	INTAKE	
V6, SOHC 12V VIN K CABEZA DE MLS	DAKOTA, RAM 1500, JEEP LIBERTY (CABEZA EN MLS).	2002/2005	CA-271-ML 	MS-4271 	
FS-271-ML 			MULTIPLE DE ESCAPE EXHAUST MS-4271-E 	PUNTERIAS VALVE COVER VS-3271-R 	CARTER OIL PAN OS-1271-R 
DISTRIBUCIÓN TIMING COVER TC-6271	 RETÉN CIGÜEÑAL CRANK SEAL BS-7271 	SELLOS DE VALVULA STEM SEALS SS-8271-12V 	JUNTAS VARIAS MISCELLANEOUS 		

3.7L	MOTOR	MODELOS	DESDE / A	JUNTA DE CABEZA	MULTIPLE DE ADMISIÓN O PLENO
ENGINE	MODELS	FROM / TO	HEAD GASKET	INTAKE	
V6, SOHC 12V VIN K	DAKOTA, RAM 1500, NITRO	2006/2012	CA-271-ML 	MS-4271 	
FS-271-1ML 			MULTIPLE DE ESCAPE EXHAUST MS-4271-E 	PUNTERIAS VALVE COVER VS-3271-1R 	CARTER OIL PAN OS-1271-R 
DISTRIBUCIÓN TIMING COVER TC-6271-2	 RETÉN CIGÜEÑAL CRANK SEAL BS-7271 	SELLOS DE VALVULA STEM SEALS SS-8271-12V 	JUNTAS VARIAS MISCELLANEOUS 		











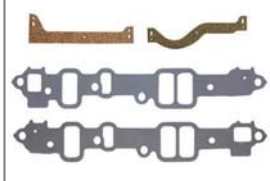
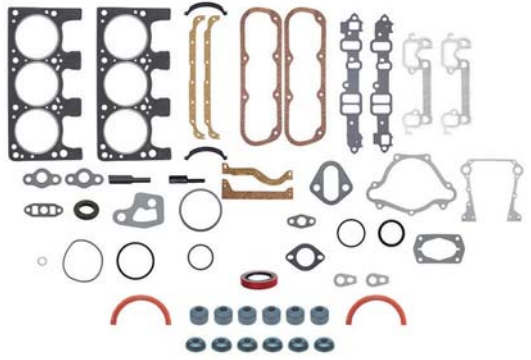
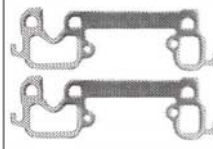
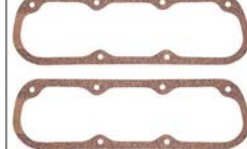



3.8L	MOTOR	MODELOS	DESDE / A	JUNTA DE CABEZA	MULTIPLE DE ADMISIÓN O PLENO
ENGINE	MODELS	FROM / TO	HEAD GASKET	INTAKE	
V6, OHV 12V VIN P, L NO INCLUYE VALLE DE ADMISION	TOWN & COUNTRY, GRAND CARAVAN, GRAND VOYAGER (CARTER Y PUNTERIAS DE SILICON).	1994/2001	CA-263-G Y CA-264-G	MS-4254-A	
<b>FS-254-1G</b> 			<p>PARA VER IMAGEN DIRIGIRSE A SECCIÓN DE JUNTAS DE CABEZA.</p> <p>TO SEE IMAGE GO TO HEAD GASKET SECTION</p>		
<b>DISTRIBUCIÓN</b> TIMING COVER TC-6254 		<b>RETÉN CIGÜEÑAL</b> CRANK SEAL BS-7240-1 	<b>SELLOS DE VALVULA</b> STEM SEALS SS-8240-1V 	<b>JUNTAS VARIAS</b> MISCELLANEOUS N/A	N/A

3.8L	MOTOR	MODELOS	DESDE / A	JUNTA DE CABEZA	MULTIPLE DE ADMISIÓN O PLENO
ENGINE	MODELS	FROM / TO	HEAD GASKET	INTAKE	
V6, OHV 12V VIN L NO INCLUYE ADMISION	TOWN & COUNTRY, CARAVAN, VOYAGER (CARTER Y PUNTERIAS DE CORCHO).	1998/2001	CA-263-G	MS-4254-A	
<b>FS-263</b> 					
<b>DISTRIBUCIÓN</b> TIMING COVER TC-6254 		<b>RETÉN CIGÜEÑAL</b> CRANK SEAL BS-7253 	<b>SELLOS DE VALVULA</b> STEM SEALS SS-8240-S 	<b>JUNTAS VARIAS</b> MISCELLANEOUS N/A	N/A

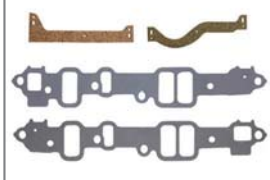
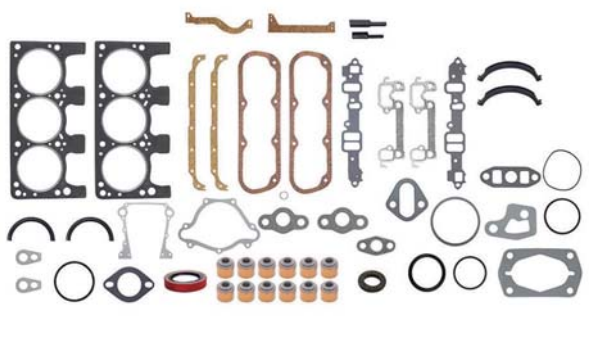
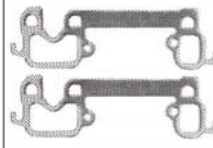



3.9L	MOTOR	MODELOS	DESDE / A	JUNTA DE CABEZA		MÚLTIPLE DE ADMISIÓN O PLENO
ENGINE	MODELS	FROM / TO	HEAD GASKET		INTAKE	
V6, OHV 12V VIN X	DAKOTA AMERICANAS, B150, B250	1987/1989	<b>CA-265-G</b> 		<b>MS-4265</b> 	
<b>FS-265</b> 			<b>MÚLTIPLE DE ESCAPE</b> <b>EXHAUST</b> <b>MS-4265-E</b> 	<b>PUNTERIAS</b> <b>VALVE COVER</b> <b>VS-3265</b> 	<b>CARTER</b> <b>OIL PAN</b> <b>OS-1265</b> 	
<b>DISTRIBUCIÓN</b> <b>TIMING COVER</b> <b>TC-6256</b> 	<b>RETÉN CIGÜEÑAL</b> <b>CRANK SEAL</b> <b>BS-7275-R</b> 	<b>SELLOS DE VALVULA</b> <b>STEM SEALS</b> <b>SS-8260-1</b> 	<b>JUNTAS VARIAS</b> <b>MISCELLANEOUS</b> <b>N/A</b>	N/A		

3.9L	MOTOR	MODELOS	DESDE / A	JUNTA DE CABEZA		MÚLTIPLE DE ADMISIÓN O PLENO
ENGINE	MODELS	FROM / TO	HEAD GASKET		INTAKE	
V6, OHV 12V VIN X	RAM VAN, W150, D150, D250, DAKOTA	1990/1991	<b>CA-265-G</b> 		<b>MS-4265</b> 	
<b>FS-265-1</b> 			<b>MÚLTIPLE DE ESCAPE</b> <b>EXHAUST</b> <b>MS-4265-E</b> 	<b>PUNTERIAS</b> <b>VALVE COVER</b> <b>VS-3265</b> 	<b>CARTER</b> <b>OIL PAN</b> <b>OS-1265</b> 	
<b>DISTRIBUCIÓN</b> <b>TIMING COVER</b> <b>TC-6256</b> 	<b>RETÉN CIGÜEÑAL</b> <b>CRANK SEAL</b> <b>BS-7260</b> 	<b>SELLOS DE VALVULA</b> <b>STEM SEALS</b> <b>SS-8261-1V</b> 	<b>JUNTAS VARIAS</b> <b>MISCELLANEOUS</b> <b>N/A</b>	N/A		



3.9L	MOTOR	MODELOS	DESDE / A	JUNTA DE CABEZA		MULTIPLE DE ADMISIÓN O PLENO												
ENGINE	MODELS	FROM / TO	HEAD GASKET		INTAKE													
V6, OHV 12V VIN X MOTOR MAGNUM	DAKOTA, RAM 1500, RAM VAN.	1992/2001	CA-270-G		MS-4270													
FS-270			<table border="1"> <tr> <th>MULTIPLE DE ESCAPE</th> <th>PUNTERIAS</th> <th>CARTER</th> </tr> <tr> <th>EXHAUST</th> <th>VALVE COVER</th> <th>OIL PAN</th> </tr> <tr> <td>MS-4270-E</td> <td>VS-3270-HD</td> <td>OS-1270-R</td> </tr> <tr> <td> </td> <td> </td> <td> </td> </tr> </table>		MULTIPLE DE ESCAPE	PUNTERIAS	CARTER	EXHAUST	VALVE COVER	OIL PAN	MS-4270-E	VS-3270-HD	OS-1270-R					
MULTIPLE DE ESCAPE	PUNTERIAS	CARTER																
EXHAUST	VALVE COVER	OIL PAN																
MS-4270-E	VS-3270-HD	OS-1270-R																
DISTRIBUCIÓN	RETÉN CIGÜEÑAL	SELLOS DE VALVULA	JUNTAS VARIAS	N/A														
TIMING COVER	CRANK SEAL	STEM SEALS	MISCELLANEOUS															
TC-6270	BS-7270-R	SS-8270-V	N/A															

4.7L	MOTOR	MODELOS	DESDE / A	JUNTA DE CABEZA		MULTIPLE DE ADMISIÓN O PLENO												
ENGINE	MODELS	FROM / TO	HEAD GASKET		INTAKE													
V8, SOHC 16V VIN J, P, N MOTOR POWER TECH CABEZA DE GRAFITO	RAM 1500, 2500, GRAND CHE-ROKEE, DURANGO, DAKOTA (CABEZA EN GRAFITO).	1999/2005	CA-272-G		MS-4272													
FS-272			<table border="1"> <tr> <th>MULTIPLE DE ESCAPE</th> <th>PUNTERIAS</th> <th>CARTER</th> </tr> <tr> <th>EXHAUST</th> <th>VALVE COVER</th> <th>OIL PAN</th> </tr> <tr> <td>MS-4272-E</td> <td>VS-3272-R</td> <td>OS-1272-R</td> </tr> <tr> <td> </td> <td> </td> <td> </td> </tr> </table>		MULTIPLE DE ESCAPE	PUNTERIAS	CARTER	EXHAUST	VALVE COVER	OIL PAN	MS-4272-E	VS-3272-R	OS-1272-R					
MULTIPLE DE ESCAPE	PUNTERIAS	CARTER																
EXHAUST	VALVE COVER	OIL PAN																
MS-4272-E	VS-3272-R	OS-1272-R																
DISTRIBUCIÓN	RETÉN CIGÜEÑAL	SELLOS DE VALVULA	JUNTAS VARIAS	N/A														
TIMING COVER	CRANK SEAL	STEM SEALS	MISCELLANEOUS															
TC-6271	BS-7271	SS-8271-1V	N/A															



4.7L	MOTOR	MODELOS	DESDE / A	JUNTA DE CABEZA		MÚLTIPLE DE ADMISIÓN O PLENO
ENGINE	MODELS	FROM / TO	HEAD GASKET		INTAKE	
V8, SOHC 16V VIN J, P, N MOTOR POWER TECH CABEZA DE MLS	RAM 1500, 2500, GRAND CHE-ROKEE, DURANGO, DAKOTA (CABEZA EN MLS).	1999/2005	<b>CA-272-ML</b> 		<b>MS-4272</b> 	
<b>FS-272-ML</b>						
<b>MÚLTIPLE DE ESCAPE</b>		<b>PUNTERIAS</b>		<b>CARTER</b>		
<b>EXHAUST</b>		<b>VALVE COVER</b>		<b>OIL PAN</b>		
<b>MS-4272-E</b>		<b>VS-3272-R</b>		<b>OS-1272-R</b>		
<b>DISTRIBUCIÓN</b>	<b>RETÉN CIGÜEÑAL</b>			<b>SELLOS DE VALVULA</b>	<b>JUNTAS VARIAS</b>	N/A
<b>TIMING COVER</b>	<b>CRANK SEAL</b>			<b>STEM SEALS</b>	<b>MISCELLANEOUS</b>	
<b>TC-6272</b>	<b>BS-7271</b>				<b>N/A</b>	

5.2L	MOTOR	MODELOS	DESDE / A	JUNTA DE CABEZA		MÚLTIPLE DE ADMISIÓN O PLENO
ENGINE	MODELS	FROM / TO	HEAD GASKET		INTAKE	
V8, OHV 16V VIN Y	B150, B250, B350, W150, W250, RAMCHARGER, DAKOTA.	1989/1992	<b>CA-275-G</b> 		<b>MS-4275</b> 	
<b>FS-275</b>						
<b>MÚLTIPLE DE ESCAPE</b>		<b>PUNTERIAS</b>		<b>CARTER</b>		
<b>EXHAUST</b>		<b>VALVE COVER</b>		<b>OIL PAN</b>		
<b>MS-4261-E</b>		<b>VS-3260-HD</b>		<b>OS-1256-2</b>		
<b>DISTRIBUCIÓN</b>	<b>RETÉN CIGÜEÑAL</b>			<b>SELLOS DE VALVULA</b>	<b>JUNTAS VARIAS</b>	N/A
<b>TIMING COVER</b>	<b>CRANK SEAL</b>			<b>STEM SEALS</b>	<b>MISCELLANEOUS</b>	
<b>TC-6270</b>	<b>BS-7260</b>				<b>N/A</b>	





5.2L	MOTOR	MODELOS	DESDE / A	JUNTA DE CABEZA	MULTIPLE DE ADMISIÓN O PLENO		
ENGINE	MODELS	FROM / TO	HEAD GASKET	INTAKE			
V8, OHV 16V VIN Y, T	RAM 1500, 2500, 3500, DURANGO, GRAND CHEVROKKEE, B1500, 2500, 3500	1992/2002	CA-275-G	MS-4275-1			
<b>FS-275-2</b>			<b>MULTIPLE DE ESCAPE</b> EXHAUST MS-4275-E	<b>PUNTERIAS</b> VALVE COVER VS-3275-HD	<b>CARTER</b> OIL PAN OS-1275-R		
<b>DISTRIBUCIÓN</b> TIMING COVER TC-6270		<b>RETÉN CIGÜEÑAL</b> CRANK SEAL BS-7270-R		<b>SELLOS DE VALVULA</b> STEM SEALS SS-8270-V		<b>JUNTAS VARIAS</b> MISCELLANEOUS N/A	

5.7L	MOTOR	MODELOS	DESDE / A	JUNTA DE CABEZA	MULTIPLE DE ADMISIÓN O PLENO		
ENGINE	MODELS	FROM / TO	HEAD GASKET	INTAKE			
V8, OHV 16V MOTOR HEMI CABEZA DE GRAFITO	300C, CHALLENGER, CHARGER.	2005/2012	CA-273-G Y CA-274-G	MS-4273			
			<p>PARA VER IMAGEN DIRIGIRSE A SECCIÓN DE JUNTAS DE CABEZA.</p> <p>TO SEE IMAGE GO TO HEAD GASKET SECTION</p>				
<b>FS-273</b>			<b>MULTIPLE DE ESCAPE</b> EXHAUST MS-4273-E	<b>PUNTERIAS</b> VALVE COVER VS-3273-R	<b>CARTER</b> OIL PAN OS-1273-R		
<b>DISTRIBUCIÓN</b> TIMING COVER TC-6273		<b>RETÉN CIGÜEÑAL</b> CRANK SEAL BS-7271		<b>SELLOS DE VALVULA</b> STEM SEALS SS-8273-V		<b>JUNTAS VARIAS</b> MISCELLANEOUS N/A	





5.7L	MOTOR	MODELOS	DESDE / A	JUNTA DE CABEZA	MULTIPLE DE ADMISIÓN O PLENO
ENGINE	MODELS	FROM / TO	HEAD GASKET	INTAKE	
V8, OHV 16V MOTOR HEMI CABEZA DE MLS	RAM 1500, 2500, 3500, DURANGO, GRAND CHE- ROKEE, COMAN- DER	2003/2009	CA-273-ML Y CA-279-ML	MS-4273	
<b>FS-273-ML</b> 			<p>PARA VER IMAGEN DIRIGIRSE A SECCIÓN DE JUNTAS DE CABEZA.</p> <p>TO SEE IMAGE GO TO HEAD GASKET SECTION</p>		
			MULTIPLE DE ESCAPE	PUNTERIAS	CARTER
			EXHAUST	VALVE COVER	OIL PAN
			MS-4273-E	VS-3273-R	OS-1273-1R
DISTRIBUCIÓN	RETÉN CIGÜEÑAL		SELLOS DE VALVULA	JUNTAS VARIAS	
TIMING COVER	CRANK SEAL		STEM SEALS	MISCELLANEOUS	
TC-6273	BS-7271		SS-8273-V		

5.9L	MOTOR	MODELOS	DESDE / A	JUNTA DE CABEZA	MULTIPLE DE ADMISIÓN O PLENO
ENGINE	MODELS	FROM / TO	HEAD GASKET	INTAKE	
V8, OHV 16V VIN W, 5, Z, T, W, U	RAMCHARGER, W150, W250, W350, D250, D350, CAMION MICRO	1981/1989	CA-260-G	MS-4260	
<b>FS-260-3</b> 					
			MULTIPLE DE ESCAPE	PUNTERIAS	CARTER
			EXHAUST	VALVE COVER	OIL PAN
			MS-4261-E	VS-3260	OS-1256-3
DISTRIBUCIÓN	RETÉN CIGÜEÑAL		SELLOS DE VALVULA	JUNTAS VARIAS	
TIMING COVER	CRANK SEAL		STEM SEALS	MISCELLANEOUS	
TC-6256	BS-7260		SS-8261-1V		N/A



5.9L	MOTOR	MODELOS	DESDE / A	JUNTA DE CABEZA		MÚLTIPLE DE ADMISIÓN O PLENO
ENGINE		MODELS	FROM / TO	HEAD GASKET		INTAKE
V8, OHV 16V VIN 5, Z		RAMCHARGER, D150, D250, D350, W150, W250, W350, MICROBUS	1990/1992	CA-260-G 		MS-4260-2 
<b>FS-260-6</b>						
<b>DISTRIBUCIÓN</b>		<b>RETÉN CIGÜEÑAL</b>		<b>SELLOS DE VALVULA</b>		<b>JUNTAS VARIAS</b>
<b>TIMING COVER</b>		<b>CRANK SEAL</b>		<b>STEM SEALS</b>		<b>MISCELLANEOUS</b>
TC-6256 		BS-7260 		SS-8261-1V 		N/A

5.9L	MOTOR	MODELOS	DESDE / A	JUNTA DE CABEZA		MÚLTIPLE DE ADMISIÓN O PLENO
ENGINE		MODELS	FROM / TO	HEAD GASKET		INTAKE
V8, OHV 16V VIN Z MOTOR MAGNUM		RAM 1500, 2500, 3500, DURANGO, DAKOTA	1993/2003	CA-275-G 		MS-4275-1 
<b>FS-275-1</b>						
<b>DISTRIBUCIÓN</b>		<b>RETÉN CIGÜEÑAL</b>		<b>SELLOS DE VALVULA</b>		<b>JUNTAS VARIAS</b>
<b>TIMING COVER</b>		<b>CRANK SEAL</b>		<b>STEM SEALS</b>		<b>MISCELLANEOUS</b>
TC-6270 		BS-7275-R 		SS-8270-V 		N/A



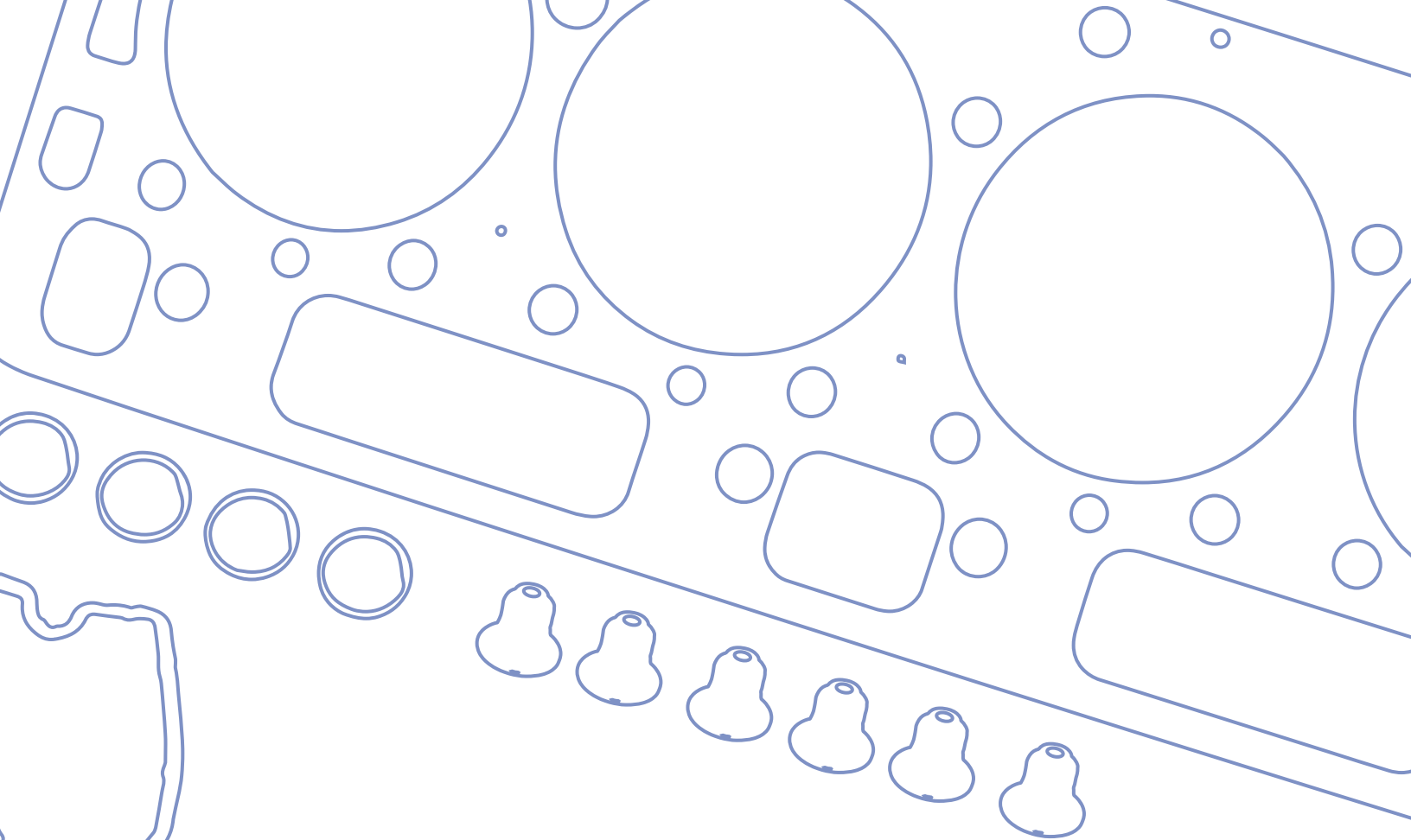

**FORD**

**MARCA  
/MAKE**

CATÁLOGO DE APLICACIONES / APPLICATION CATALOG

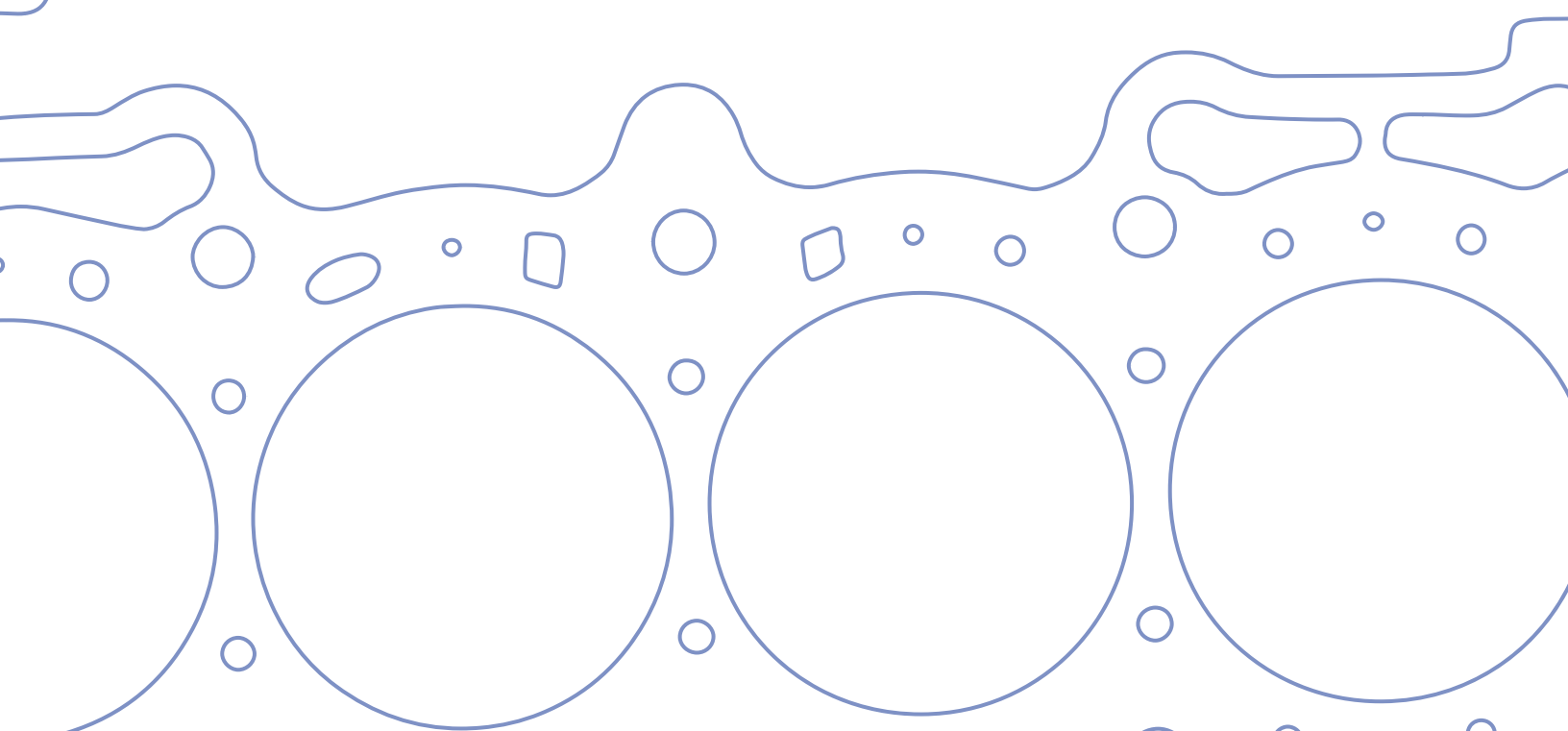







LITROS	MODELO	AÑO	PÁGINA
LITERS	MODEL	YEAR	PAGE
1.3L	FIESTA.	1997/2001	55
1.4L	FIESTA.	1998/2001	*
1.6L	FIESTA, IKON, Ka, COURIER.	2001/2010	55
1.6L	MAZDA 3.	2006/2007	*
1.8L	ESCORT, TRACER.	1991/1996	*
1.8L	COURIER PICKUP	1974	*
1.9L	MERCURY TRACER, ESCORT.	1981/1999	56
1.9L	ESCORT TRACER.	1991/1996	56
2.0L	ESCORT, TRACER, FOCUS.	1981/2004	57
2.0L	FOCUS.	2000/2004	57
2.0L	MAZDA B2000, COURIER.	1970/1984	58
2.0L	COURIER MA/MB	1979/1982	58
2.0L	COURIER PICKUP ; MAZDA 626, B2000	1979/1984	*
2.0L	RANGER.	1983-1986	59
2.0L	RANGER	1987/1988	59
2.0L	CONTOUR, ESCORT, FOCUS, ZX2.	1995/1997	60
2.0L	CONTOUR, MYSTIQUE, ESCORT,	1995/1999	*
2.0L	FOCUS, ESCORT	2001/2003	*
2.0L	FOCUS SVT	2002/2004	*
2.0L	FOCUS	2000/2003	*
2.0L	ECOSPORT, FOCUS.	2001/2010	60
2.0L	ECOSPORT, MEXICO.	2005/2009	*
2.0L	ECOSPORT	2005/2008	61
2.2L	TRANSIT VAN.	2008/2012	*
2.3L	TEMPO, TOPAZ.	1984/1994	61
2.3L	RANGER.	1974/2002	62
2.3L	RANGER	1981/1986	62
2.3L	MUSTANG, COUGAR, MARQUIS	1986/1988	63
2.3L	MUSTANG, RANGER	1989/1990	63
2.3L	RANGER	1988/1992	64
2.3L	RANGER	1985/1986	64
2.3L	RANGER	1986/1987	65
2.3L	RANGER	1993/1994	65
2.3L	RANGER	1998/2001	66
2.3L	FUSION, MILAN, MAZDA 3.	2006/2009	*
2.4L	FALCON, MAVERICK, CUSTOM ECONOLINE.	1960/1983	*
2.5L	TEMPO, TOPAZ GLS	1989/1994	66
2.5L	CONTOUR, MYSTIQUE, MAZDA MPV.	1995/2000	*
2.5L	CONTOUR, MYSTIQUE.	1995/2000	*
2.5L	PROBE, 626, MILLENIA.	1993/1997	*
2.5L	CONTOUR, TAURUS, MYSTIQUE	1995/2002	*
2.5L	COUGAR, MAZDA MPV.	2001/2002	*
2.8L	AEROSTAR, BRONCO II, RANGER.	1974/1986	67
2.8L	AEROSTAR BRONCO II RANGER	1983/1986	67
2.8L	BRONCO II, RANGER.	1974/1986	*



LITROS	MODELO	AÑO	PÁGINA
LITERS	MODEL	YEAR	PAGE
2.8L	FALCON, MAVERICK, CUSTOM ECONOLINE,	1960/1972	*
2.9L	RANGER, BRONCO II, SCORPIO	1986/1992	68
2.9L	EXPLORER, RANGER.	1986/1992	*
3.0L	RANGER, AEROSTAR, TAURUS.	1986/1990	68
3.0L	RANGER	1990	69
3.0L	TAURUS SABLE TEMPO TOPAZ	1992/1994	69
3.0L	AEROSTAR, B3000.	1986/1990	70
3.0L	AEROSTAR	1990/1990	70
3.0L	AEROSTAR	1996/1997	71
3.0L	AEROSTAR, B3000.	1986/1995	*
3.0L	TAURUS, SABLE.	1999/2004	*
3.0L	TAURUS.	2001/2004	*
3.0L	ESCAPE, TAURUS, SABLE.	2001/2004	*
3.0L	TAURUS, TRIBUTE, SABLE.	1999/2004	*
3.0L	SABLE, TAURUS	2000/2002	*
3.0L	LINCOLN LS	2002/2005	*
3.5L	CUSTOM, WAGON PICK-UP.	1954-1964	71
3.8L	FORD FAIRMONT.	1982/1983	72
3.8L	COUGAR, THUNDERBIRD	1984/1987	72
3.8L	COUGAR, THUNDERBIRD	1988/1994	*
3.8L	COUGAR, THUNDERBIRD SUPERCHARGED	1989/1993	73
3.8L	TAURUS, CONTINENTAL, SABLE	1994/1995	73
3.8L	WINDSTAR	1998/2001	*
3.8L	WINDSTAR.	1994/1995	74
3.8L	TAURUS, CONTINENTAL, SABLE	1989/1993	74
3.8L	AUTOS, WINDSTAR	1994/1995	75
3.8L	WINDSTAR, ECONOLINE.	1997/1998	75
3.8L	MUSTANG, WINDSTAR, LOBO F-150.	1995/2003	*
3.8L	WINDSTAR, F-150,	1997/1998	76
3.8L	WINDSTAR, F-150, ECONOLINE	1997/1998	76
3.8L	WINDSTAR, F-150, ECONOLINE	2001/2004	77
3.8L	WINDSTAR, F-150, LOBO.	1995/2003	*
3.8L	LOBO, E-150, F-150, PICK-UP.	1998/2004	*
3.9L	AUTOS Y CAMIONETAS.	1965/1986	*
3.9L	AUTOS Y CAMIONETAS	1987	*
3.9L	CAMIONES, AUTOS	1955/1959	*
4.0L	EXPLORER, RANGER.	1990/1994	77
4.0L	AEROSTAR, EXPLORER, RANGER	1997/2000	78
4.0L	EXPLORER, MONTAINNER.	1997/2001	78
4.0L	EXPLORER, MONTAINNER.	1997/2010	*
4.0L	EXPLORER, RANGER.	1997/2010	*
4.1L	AUTOS CAMIONES	1969/1980	79
4.2L	AUTOS MERCURY.	1949/1954	*
4.2L	MUSTANG, THUNDERBIRD, CAPRI.	1980/1982	*
4.6L	C.VICTORIA, CONTINENTAL, GRAND MARQUIS.	1991/1994	79

\* Escanear código QR para consultar en catálogo electrónico o diríjase a [catalogo.dcp.com.mx](http://catalogo.dcp.com.mx).



LITROS	MODELO	AÑO	PÁGINA
LITERS	MODEL	YEAR	PAGE
4.6L	MUSTANG , GRAND MARQUIS.	1995/1998	80
4.6L	F-250 PICK-UP	1996/1999	80
4.6L	F-150,F-250,LOBO TRUCKS	1997/1999	81
4.6L	GRAND MARQUIS, F-150, F250, LOBO.	2000/2003	81
4.6L	GRAND MARQUIS, F-150, F250, LOBO.	1997/1999	82
4.9L	BRONCO,ECONOLINE,F-150,F-250	1988/1991	*
4.9L	BRONCO,ECONOLINE,F-150,F-250	1991/1997	*
4.9L	BRONCO,ECONOLINE,F-150,F-250	1991/1992	*
4.9L	BRONCO,ECONOLINE,F-150,F-250	1988/1997	*
5.0L	AUTOS Y CAMIONES.	1962/1997	*
5.0L	BRONCO,CUSTOM,ECONOLINE,MUSTANG	1962/1978	82
5.0L	BRONCO,CUSTOM,ECONOLINE,MUSTANG	1979/1982	83
5.0L	AUTOS Y CAMIONES	1982/1985	83
5.0L	GRAND MARQUIS ,CROWN VICTORIA	1986/1990	84
5.0L	F-250,F-350,COUGAR,THUNDERBIRD	1991/1997	84
5.0L	COUGAR,GRAND MARQUIS,F-250,	1991/1997	85
5.4L	AUTOS Y CAMIONES.	1961/1976	85
5.4L	F-250, F-150, LOBO , G, MARQUIS.	1991/2007	*
5.4L	F-150,F-250,LOBO TRUCKS	1997/1998	*
5.4L	F-150, F250, LOBO.	1991/2009	*
5.4L	EXPEDITION , LOBO, F-150, F-250 NAVIGATOR.	2004/2010	*
5.4L	TRUCKS F-500	1973/1978	*
5.8L	TRUCKS, GALAXIE, GRAND MARQUIS.	1969/1983	86
5.8L	AUTOS Y CAMIONES	1975/983	86
5.8L	AUTOS Y CAMIONES	1984/1990	87
5.8L	F-250,F-350,MICROBUS	1991/1997	87
5.8L	F-150, PICK-UP, TRUCKS.	1970/1982	88
6.1L	CAMIONES.	1979/1989	88
6.8L	TRUCKS, F-450 SUPER DUTY.	1997/1999	89
6.8L	TRUCKS, F-450 SUPER DUTY, EXCURSION.	1997/2003	*
6.8L	F-450,SUPER DUTY.	1999/2007	*
6.8L	ECONOLINE, SUPER DUTY , F-450.	1997/2003	*
7.0L	GALAXIE, CUSTOM 500, F-350, F-600.	1968/1985	89
7.3L	F SUPER DUTY ,F-250-E250-E-350	1988/1995	*
7.3L	E-250, E-350, ECONOLINE.	1994/2003	*
7.5L	GALAXIE, CUSTOM 500, F-350, F-700.	1968/1985	90
7.5L	E-250,SUPER DUTY F-250	1988/1997	*







1.3L	MOTOR	MODELOS	DESDE / A	JUNTA DE CABEZA	MÚLTIPLE DE ADMISIÓN O PLENO
ENGINE	MODELS	FROM / TO	HEAD GASKET	INTAKE	
4L OHV 8V ENDURA	FIESTA.	1997/2001	CA-302-G 	MS-4302 	
FS-302 			MÚLTIPLE DE ESCAPE EXHAUST MS-4302-E 	PUNTERIAS VALVE COVER VS-3302 	CARTER OIL PAN OS-1302 
DISTRIBUCIÓN TIMING COVER TC-6302 	RETÉN CIGÜEÑAL CRANK SEAL BS-7302 	SELLOS DE VALVULA STEM SEALS SS-8302-V 	JUNTAS VARIAS MISCELLANEOUS		

1.6L	MOTOR	MODELOS	DESDE / A	JUNTA DE CABEZA	MÚLTIPLE DE ADMISIÓN O PLENO
ENGINE	MODELS	FROM / TO	HEAD GASKET	INTAKE	
4L SOHC 8V ZETEC ROCAM	FIESTA, IKON, Ka, COURIER.	2001/2010	CA-317-G Y CA-317-GX  PARA VER IMAGEN DIRIGIRSE A SECCIÓN DE JUNTAS DE CABEZA. TO SEE IMAGE GO TO HEAD GASKET SECTION	MS-4317 	
FS-317 			MÚLTIPLE DE ESCAPE EXHAUST MS-4317-E 	PUNTERIAS VALVE COVER VS-3317-R 	CARTER OIL PAN OS-1317-R 
DISTRIBUCIÓN TIMING COVER TC-6317 	RETÉN CIGÜEÑAL CRANK SEAL BS-7317-NT 	SELLOS DE VALVULA STEM SEALS SS-8317-V 	JUNTAS VARIAS MISCELLANEOUS		



1.9L	MOTOR	MODELOS	DESDE / A	JUNTA DE CABEZA		MÚLTIPLE DE ADMISIÓN O PLENO
ENGINE	MODELS	FROM / TO	HEAD GASKET		INTAKE	
4L SOHC 8V	MERCURY TRACER, ESCORT.	1981/1999	CA-303-G		MS-4303	
FS-303			MÚLTIPLE DE ESCAPE		PUNTERIAS	CARTER
			EXHAUST		VALVE COVER	OIL PAN
			MS-4303-E	VS-3303	OS-1303	
DISTRIBUCIÓN		RETÉN CIGÜEÑAL		SELLOS DE VALVULA		JUNTAS VARIAS
TIMING COVER		CRAK SEAL		STEM SEALS		MISCELLANEOUS
TC-6303-2		BS-7300		SS-8303-V		

1.9L	MOTOR	MODELOS	DESDE / A	JUNTA DE CABEZA		MÚLTIPLE DE ADMISIÓN O PLENO
ENGINE	MODELS	FROM / TO	HEAD GASKET		INTAKE	
4L SOHC 8V	ESCORT TRACER.	1991/1996	CA-303-1G		MS-4301	
FS-303-2			MÚLTIPLE DE ESCAPE		PUNTERIAS	CARTER
			EXHAUST		VALVE COVER	OIL PAN
			MS-4303-E	VS-3303-2	OS-1303-1R	
DISTRIBUCIÓN		RETÉN CIGÜEÑAL		SELLOS DE VALVULA		JUNTAS VARIAS
TIMING COVER		CRAK SEAL		STEM SEALS		MISCELLANEOUS
TC-6303-2		BS-7300		SS-8301-V		



2.0L	MOTOR	MODELOS	DESDE / A	JUNTA DE CABEZA	MÚLTIPLE DE ADMISIÓN O PLENO
ENGINE	MODELS	FROM / TO	HEAD GASKET	INTAKE	
4L SOHC 8V	ESCORT, TRACER, FOCUS.	1981/2004	CA-303-1G 	MS-4301 	
FS-303-1 			MÚLTIPLE DE ESCAPE EXHAUST MS-4303-E 	PUNTERIAS VALVE COVER VS-3303-1R 	CARTER OIL PAN OS-1303-1R 
DISTRIBUCIÓN TIMING COVER TC-6303-2 	RETÉN CIGÜEÑAL CRANK SEAL BS-7300 	SELLOS DE VALVULA STEM SEALS SS-8301-V 	JUNTAS VARIAS MISCELLANEOUS		

2.0L	MOTOR	MODELOS	DESDE / A	JUNTA DE CABEZA	MÚLTIPLE DE ADMISIÓN O PLENO
ENGINE	MODELS	FROM / TO	HEAD GASKET	INTAKE	
4L SOHC 8V SPI	FOCUS	2000/2005	CA-303-1G 	MS-4303-3 	
FS-303-4 			MÚLTIPLE DE ESCAPE EXHAUST MS-4303-E 	PUNTERIAS VALVE COVER VS-3303-3HD 	CARTER OIL PAN OS-1303-2R 
DISTRIBUCIÓN TIMING COVER TC-6303-2 	RETÉN CIGÜEÑAL CRANK SEAL BS-7300 	SELLOS DE VALVULA STEM SEALS SS-8301-V 	JUNTAS VARIAS MISCELLANEOUS		





2.0L	MOTOR	MODELOS	DESDE / A
ENGINE		MODELS	FROM / TO
4L OHV		MAZDA B2000, COURIER.	1970/1984

FS-304

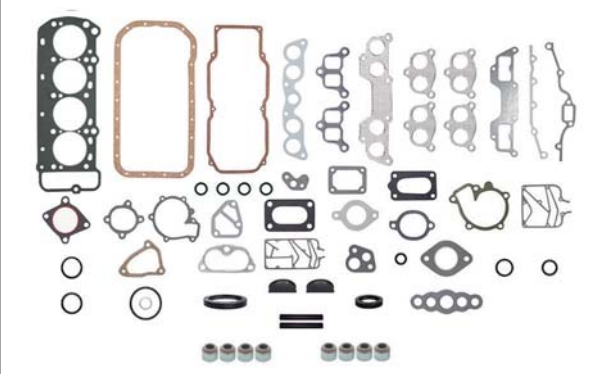

JUNTA DE CABEZA
HEAD GASKET
CA-304-G

MULTIPLE DE ADMISIÓN O PLENO
INTAKE
MS-4304

MULTIPLE DE ESCAPE
EXHAUST
MS-4304-E

PUNTERIAS
VALVE COVER
VS-3304

CARTER
OIL PAN
OS-1304

DISTRIBUCIÓN
TIMING COVER
TC-6304



RETÉN CIGÜEÑAL
CRANK SEAL
BS-7304



SELLOS DE VALVULA
STEM SEALS
SS-8304-V



JUNTAS VARIAS
MISCELLANEOUS

2.0L	MOTOR	MODELOS	DESDE / A
ENGINE		MODELS	FROM / TO
4L SOHC 8V		COURIER MA/MB	1979/1982

FS-304-1



JUNTA DE CABEZA
HEAD GASKET
CA-304-G

MULTIPLE DE ADMISIÓN O PLENO
INTAKE
MS-4304-1

MULTIPLE DE ESCAPE
EXHAUST
MS-4304-E

PUNTERIAS
VALVE COVER
VS-3304

CARTER
OIL PAN
OS-1304

DISTRIBUCIÓN
TIMING COVER
TC-6304



RETÉN CIGÜEÑAL
CRANK SEAL
BS-7304



SELLOS DE VALVULA
STEM SEALS
SS-8304-V



JUNTAS VARIAS
MISCELLANEOUS



2.0L	MOTOR	MODELOS	DESDE / A	JUNTA DE CABEZA	MULTIPLE DE ADMISIÓN O PLENO		
ENGINE	MODELS	FROM / TO	HEAD GASKET	INTAKE			
4L SOHC 8V CARB	RANGER.	1983-1986	CA-306-G	MS-4306			
<b>FS-306</b> 							
			MULTIPLE DE ESCAPE	PUNTERIAS	CARTER		
			EXHAUST	VALVE COVER	OIL PAN		
			MS-4305-E	VS-3306	OS-1305		
DISTRIBUCIÓN		RETÉN CIGÜEÑAL		SELLOS DE VALVULA		JUNTAS VARIAS	
TIMING COVER		CRANK SEAL		STEM SEALS		MISCELLANEOUS	
TC-6305		BS-7305		SS-8300		RE-16018	

2.0L	MOTOR	MODELOS	DESDE / A	JUNTA DE CABEZA	MULTIPLE DE ADMISIÓN O PLENO		
ENGINE	MODELS	FROM / TO	HEAD GASKET	INTAKE			
4L SOHC 8V	RANGER	1987/1988	CA-306-G	MS-4306			
<b>FS-306-1</b> 							
			MULTIPLE DE ESCAPE	PUNTERIAS	CARTER		
			EXHAUST	VALVE COVER	OIL PAN		
			MS-4305-E	VS-3305	OS-1305-2R		
DISTRIBUCIÓN		RETÉN CIGÜEÑAL		SELLOS DE VALVULA		JUNTAS VARIAS	
TIMING COVER		CRANK SEAL		STEM SEALS		MISCELLANEOUS	
TC-6305		BS-7305		SS-8331-V			



2.0L	MOTOR	MODELOS	DESDE / A	JUNTA DE CABEZA		MÚLTIPLE DE ADMISIÓN O PLENO
ENGINE	MODELS	FROM / TO	HEAD GASKET		INTAKE	
4L DOHC 16V	CONTOUR, ESCORT, FOCUS, ZX2.	1995/1997	CA-313-G		MS-4313	
DISTRIBUCIÓN		RETÉN CIGÜEÑAL	SELLOS DE VALVULA		JUNTAS VARIAS	
TIMING COVER		CRANK SEAL	STEM SEALS		MISCELLANEOUS	
TC-6313						
MULTIPLE DE ESCAPE		PUNTERIAS		CARTER		
EXHAUST		VALVE COVER		OIL PAN		
MS-4313-E		VS-3313-R		OS-1313-R		

2.0L	MOTOR	MODELOS	DESDE / A	JUNTA DE CABEZA		MÚLTIPLE DE ADMISIÓN O PLENO
ENGINE	MODELS	FROM / TO	HEAD GASKET		INTAKE	
4L DOHC 16V VIN D,H	ECOSPORT, FOCUS.	2001/2010	CA-348-G		MS-4348	
DISTRIBUCIÓN		RETÉN CIGÜEÑAL	SELLOS DE VALVULA		JUNTAS VARIAS	
TIMING COVER		CRANK SEAL	STEM SEALS		MISCELLANEOUS	
TC-6348						
MULTIPLE DE ESCAPE		PUNTERIAS		CARTER		
EXHAUST		VALVE COVER		OIL PAN		
MS-4348-E		VS-3348-R				





2.0L	MOTOR	MODELOS	DESDE / A	JUNTA DE CABEZA		MÚLTIPLE DE ADMISIÓN O PLENO
ENGINE	MODELS	FROM / TO	HEAD GASKET		INTAKE	
4L DOHC 16V VIN H	ECOSPORT	2005/2008	CA-348-G		MS-4348	
<b>FS-348-1</b> 						
DISTRIBUCIÓN		RETÉN CIGÜEÑAL	SELLOS DE VALVULA		JUNTAS VARIAS	
TIMING COVER		CRANK SEAL	STEM SEALS		MISCELLANEOUS	
TC-6348		BS-7348-AT	SS-8348-V			

2.3L	MOTOR	MODELOS	DESDE / A	JUNTA DE CABEZA		MÚLTIPLE DE ADMISIÓN O PLENO
ENGINE	MODELS	FROM / TO	HEAD GASKET		INTAKE	
4L OHV 8V VIN R S X	TEMPO, TOPAZ.	1984/1994	CA-300-G		MS-4300	
<b>FS-300</b> 						
DISTRIBUCIÓN		RETÉN CIGÜEÑAL	SELLOS DE VALVULA		JUNTAS VARIAS	
TIMING COVER		CRANK SEAL	STEM SEALS		MISCELLANEOUS	
TC-6300		BS-7300	SS-8300			





2.3L	MOTOR	MODELOS	DESDE / A	JUNTA DE CABEZA	MULTIPLE DE ADMISIÓN O PLENO
ENGINE	MODELS	FROM / TO	HEAD GASKET	INTAKE	
4L SOHC 8V	RANGER.	1974/2002	CA-305-G 	MS-4305 	
FS-305 			MULTIPLE DE ESCAPE EXHAUST	PUNTERIAS VALVE COVER	CARTER OIL PAN
			MS-4305-E 	VS-3305 	OS-1305 
DISTRIBUCIÓN TIMING COVER		RETÉN CIGÜEÑAL CRANK SEAL		SELLOS DE VALVULA STEM SEALS	JUNTAS VARIAS MISCELLANEOUS
TC-6305		BS-7321	SS-8300 		

2.3L	MOTOR	MODELOS	DESDE / A	JUNTA DE CABEZA	MULTIPLE DE ADMISIÓN O PLENO
ENGINE	MODELS	FROM / TO	HEAD GASKET	INTAKE	
4L SOHC 8V	RANGER	1981/1986	CA-305-G 	MS-4305 	
FS-305-1 			MULTIPLE DE ESCAPE EXHAUST	PUNTERIAS VALVE COVER	CARTER OIL PAN
			MS-4305-E 	VS-3305 	OS-1305 
DISTRIBUCIÓN TIMING COVER		RETÉN CIGÜEÑAL CRANK SEAL		SELLOS DE VALVULA STEM SEALS	JUNTAS VARIAS MISCELLANEOUS
TC-6305		BS-7305	SS-8300 		



2.3L	MOTOR	MODELOS	DESDE / A	JUNTA DE CABEZA		MÚLTIPLE DE ADMISIÓN O PLENO
ENGINE	MODELS	FROM / TO	HEAD GASKET		INTAKE	
4L SOHC	MUSTANG, COUGAR, MARQUIS	1986/1988	CA-305-G		MS-4305	
<b>FS-305-2</b>						
MÚLTIPLE DE ESCAPE		PUNTERIAS		CARTER		
EXHAUST		VALVE COVER		OIL PAN		
MS-4305-E		VS-3305		OS-1305-1R		
DISTRIBUCIÓN		RETÉN CIGÜEÑAL		SELLOS DE VALVULA		JUNTAS VARIAS
TIMING COVER		CRANK SEAL		STEM SEALS		MISCELLANEOUS
TC-6305		BS-7305		SS-8300		

2.3L	MOTOR	MODELOS	DESDE / A	JUNTA DE CABEZA		MÚLTIPLE DE ADMISIÓN O PLENO
ENGINE	MODELS	FROM / TO	HEAD GASKET		INTAKE	
4L SOHC 8V	MUSTANG, RANGER	1989/1990	CA-305-G		MS-4305	
<b>FS-305-3</b>						
MÚLTIPLE DE ESCAPE		PUNTERIAS		CARTER		
EXHAUST		VALVE COVER		OIL PAN		
MS-4305-E		VS-3305-1R		OS-1305-1R		
DISTRIBUCIÓN		RETÉN CIGÜEÑAL		SELLOS DE VALVULA		JUNTAS VARIAS
TIMING COVER		CRANK SEAL		STEM SEALS		MISCELLANEOUS
TC-6305		BS-7305		SS-8305-8V		



2.3L	MOTOR	MODELOS	DESDE / A	JUNTA DE CABEZA		MÚLTIPLE DE ADMISIÓN O PLENO
ENGINE	MODELS	FROM / TO	HEAD GASKET		INTAKE	
4L SOHC 8V CARB	RANGER	1988/1992	CA-305-G		MS-4305	
FS-305-4						
DISTRIBUCIÓN		RETÉN CIGÜEÑAL	SELLOS DE VALVULA		JUNTAS VARIAS	
TIMING COVER		CRANK SEAL	STEM SEALS		MISCELLANEOUS	
TC-6305		BS-7305	SS-8305-8V			

2.3L	MOTOR	MODELOS	DESDE / A	JUNTA DE CABEZA		MÚLTIPLE DE ADMISIÓN O PLENO
ENGINE	MODELS	FROM / TO	HEAD GASKET		INTAKE	
4L SOHC 8V	RANGER	1985/1986	CA-305-G		MS-4305	
FS-305-6						
DISTRIBUCIÓN		RETÉN CIGÜEÑAL	SELLOS DE VALVULA		JUNTAS VARIAS	
TIMING COVER		CRANK SEAL	STEM SEALS		MISCELLANEOUS	
TC-6305		BS-7305	SS-8300			



2.3L	MOTOR	MODELOS	DESDE / A	JUNTA DE CABEZA	MULTIPLE DE ADMISIÓN O PLENO		
ENGINE	MODELS	FROM / TO	HEAD GASKET	INTAKE			
4L SOHC 8V	RANGER	1986/1987	CA-305-G	MS-4305			
<b>FS-305-7</b> 			 	  			
<b>DISTRIBUCIÓN</b>	 <b>TC-6305</b>	<b>RETÉN CIGÜEÑAL</b>	 <b>BS-7305</b>	<b>SELLOS DE VALVULA</b>	 <b>SS-8300</b>	<b>JUNTAS VARIAS</b>	 <b>MISCELLANEOUS</b>
<b>TIMING COVER</b>		<b>CRANK SEAL</b>		<b>STEM SEALS</b>			

2.3L	MOTOR	MODELOS	DESDE / A	JUNTA DE CABEZA	MULTIPLE DE ADMISIÓN O PLENO		
ENGINE	MODELS	FROM / TO	HEAD GASKET	INTAKE			
4L SOHC 8V	RANGER	1993/1994	CA-305-G	MS-4305-1			
<b>FS-305-8</b> 			 	  			
<b>DISTRIBUCIÓN</b>	 <b>TC-6305</b>	<b>RETÉN CIGÜEÑAL</b>	 <b>BS-7305</b>	<b>SELLOS DE VALVULA</b>	 <b>SS-8305-8V</b>	<b>JUNTAS VARIAS</b>	 <b>MISCELLANEOUS</b>
<b>TIMING COVER</b>		<b>CRANK SEAL</b>		<b>STEM SEALS</b>			





2.3L	MOTOR	MODELOS	DESDE / A
	ENGINE	MODELS	FROM / TO
4L SOHC 8V		RANGER	1998/2001

FS-305-9

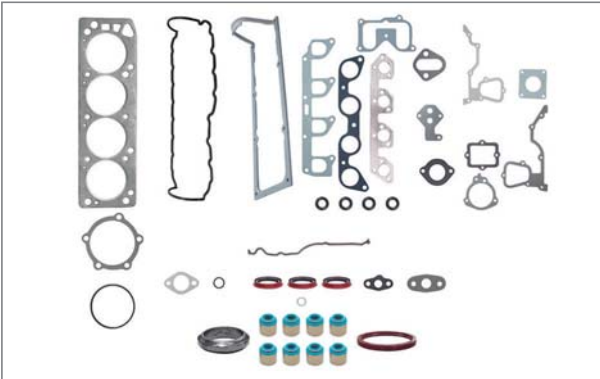

JUNTA DE CABEZA
HEAD GASKET
CA-305-G

MÚLTIPLE DE ADMISIÓN O PLENO
INTAKE
MS-4305-1

MÚLTIPLE DE ESCAPE
EXHAUST
MS-4305-E

PUNTERIAS
VALVE COVER
VS-3305-1R

CARTER
OIL PAN
OS-1305-3R

DISTRIBUCIÓN
TIMING COVER
TC-6305-3



RETÉN CIGÜEÑAL
CRANK SEAL
BS-7305



SELLOS DE VALVULA
STEM SEALS
SS-8331-V



JUNTAS VARIAS
MISCELLANEOUS



2.5L	MOTOR	MODELOS	DESDE / A
	ENGINE	MODELS	FROM / TO
4L OHV 8V		TEMPO, TOPAZ GLS	1989/1994

FS-300-1

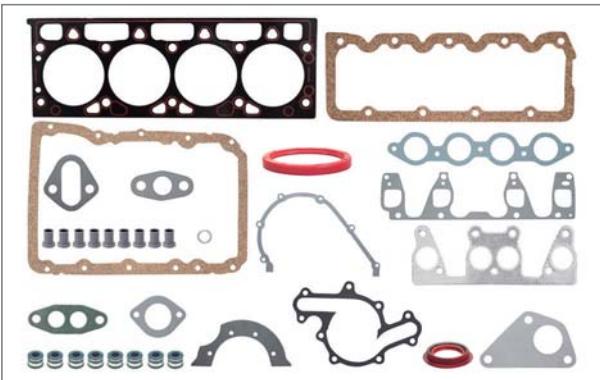

JUNTA DE CABEZA
HEAD GASKET
CA-300-G

MÚLTIPLE DE ADMISIÓN O PLENO
INTAKE
MS-4302

MÚLTIPLE DE ESCAPE
EXHAUST
MS-4302-E

PUNTERIAS
VALVE COVER
VS-3300-1

CARTER
OIL PAN
OS-1300-1

DISTRIBUCIÓN
TIMING COVER
TC-6300



RETÉN CIGÜEÑAL
CRANK SEAL
BS-7300



SELLOS DE VALVULA
STEM SEALS
SS-8300

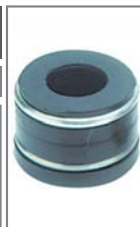

JUNTAS VARIAS
MISCELLANEOUS





2.8L	MOTOR	MODELOS	DESDE / A	JUNTA DE CABEZA	MULTIPLE DE ADMISIÓN O PLENO
ENGINE	MODELS	FROM / TO	HEAD GASKET	INTAKE	
V6 OHV 12V	AEROSTAR, BRONCO II, RANGER.	1974/1986	CA-316-G		MS-4315
FS-315					
DISTRIBUCIÓN		RETÉN CIGÜEÑAL	SELLOS DE VALVULA	JUNTAS VARIAS	
TIMING COVER		CRANK SEAL	STEM SEALS	MISCELLANEOUS	
TC-6315		BS-7315	SS-8303-V		

2.8L	MOTOR	MODELOS	DESDE / A	JUNTA DE CABEZA	MULTIPLE DE ADMISIÓN O PLENO
ENGINE	MODELS	FROM / TO	HEAD GASKET	INTAKE	
V6 OHV 12V VIN S	AEROSTAR BRONCO II RANGER	1983/1986	CA-315-G Y CA-316-G	PARA VER IMAGEN DIRIGIRSE A SECCIÓN DE JUNTAS DE CABEZA. TO SEE IMAGE GO TO HEAD GASKET SECTION	MS-4315-1
FS-315-1					
DISTRIBUCIÓN		RETÉN CIGÜEÑAL	SELLOS DE VALVULA	JUNTAS VARIAS	
TIMING COVER		CRANK SEAL	STEM SEALS	MISCELLANEOUS	
TC-6315-1		BS-7315	SS-8303-V		



2.9L	MOTOR	MODELOS	DESDE / A	JUNTA DE CABEZA	MULTIPLE DE ADMISIÓN O PLENO
ENGINE	MODELS	FROM / TO	HEAD GASKET	INTAKE	
V6 OHV 12V CARB	RANGER, BRONCO II, SCORPIO	1986/1992	<p>CA-308-G Y CA-309-G</p> <p>PARA VER IMAGEN DIRIGIRSE A SECCIÓN DE JUNTAS DE CABEZA.</p> <p>TO SEE IMAGE GO TO HEAD GASKET SECTION</p>	MS-4308-A	
FS-308					
DISTRIBUCIÓN		RETÉN CIGÜEÑAL	SELLOS DE VALVULA	JUNTAS VARIAS	
TIMING COVER		CRANK SEAL	STEM SEALS	MISCELLANEOUS	
TC-6308		BS-7315			

3.0L	MOTOR	MODELOS	DESDE / A	JUNTA DE CABEZA	MULTIPLE DE ADMISIÓN O PLENO
ENGINE	MODELS	FROM / TO	HEAD GASKET	INTAKE	
V6 OHV 12V VULCAN F.I.VIN U VIN 1	RANGER, AEROSTAR, TAURUS.	1986/1990	<p>CA-318-G</p>	MS-4318	
FS-318					
DISTRIBUCIÓN		RETÉN CIGÜEÑAL	SELLOS DE VALVULA	JUNTAS VARIAS	
TIMING COVER		CRANK SEAL	STEM SEALS	MISCELLANEOUS	
TC-6318		BS-7300	SS-8141-V		





3.0L	MOTOR	MODELOS	DESDE / A	JUNTA DE CABEZA		MULTIPLE DE ADMISIÓN O PLENO
ENGINE	MODELS	FROM / TO	HEAD GASKET		INTAKE	
V6 OHV 12V CARTER CORTO	RANGER	MAR1990/ DIC1990	CA-318-G		MS-4318	
<b>FS-318-1</b> 						
DISTRIBUCIÓN		RETÉN CIGÜEÑAL	SELLOS DE VALVULA		JUNTAS VARIAS	
TIMING COVER		CRANK SEAL	STEM SEALS		MISCELLANEOUS	
TC-6318		BS-7300				
			MS-4318-E		VS-3318-R	OS-1318-1R

3.0L	MOTOR	MODELOS	DESDE / A	JUNTA DE CABEZA		MULTIPLE DE ADMISIÓN O PLENO
ENGINE	MODELS	FROM / TO	HEAD GASKET		INTAKE	
V6 OHV 12V VULCAN F.I.VIN U VIN 1	TAURUS SABLE TEMPO TOPAZ	1992/1994	CA-318-G		MS-4318	
<b>FS-318-2</b> 						
DISTRIBUCIÓN		RETÉN CIGÜEÑAL	SELLOS DE VALVULA		JUNTAS VARIAS	
TIMING COVER		CRANK SEAL	STEM SEALS		MISCELLANEOUS	
TC-6318		BS-7300				
			MS-4318-E		VS-3318-1R	OS-1318-1R





3.0L	MOTOR	MODELOS	DESDE / A	JUNTA DE CABEZA	MULTIPLE DE ADMISIÓN O PLENO
ENGINE	MODELS	FROM / TO	HEAD GASKET	INTAKE	
V6 OHV 12V	AEROSTAR, B3000.	1986/1990	CA-322-G Y CA-323-G  PARA VER IMAGEN DIRIGIRSE A SECCIÓN DE JUNTAS DE CABEZA.  TO SEE IMAGE GO TO HEAD GASKET SECTION	MS-4318 	
FS-322 			MULTIPLE DE ESCAPE EXHAUST	PUNTERIAS VALVE COVER	CARTER OIL PAN
			MS-4318-E 	VS-3318-R 	OS-1318-R 
DISTRIBUCIÓN TIMING COVER		RETÉN CIGÜEÑAL CRANK SEAL		SELLOS DE VALVULA STEM SEALS	JUNTAS VARIAS MISCELLANEOUS
TC-6318		BS-7300		SS-8141-V 	

3.0L	MOTOR	MODELOS	DESDE / A	JUNTA DE CABEZA	MULTIPLE DE ADMISIÓN O PLENO
ENGINE	MODELS	FROM / TO	HEAD GASKET	INTAKE	
V6 OHV 12V 1G-576, 577-BA,	AEROSTAR	1990/1990	CA-322-G Y CA-323-G  PARA VER IMAGEN DIRIGIRSE A SECCIÓN DE JUNTAS DE CABEZA.  TO SEE IMAGE GO TO HEAD GASKET SECTION	MS-4318 	
FS-322-1 			MULTIPLE DE ESCAPE EXHAUST	PUNTERIAS VALVE COVER	CARTER OIL PAN
			MS-4318-E 	VS-3318-R 	OS-1318-1R 
DISTRIBUCIÓN TIMING COVER		RETÉN CIGÜEÑAL CRANK SEAL		SELLOS DE VALVULA STEM SEALS	JUNTAS VARIAS MISCELLANEOUS
TC-6318		BS-7300		SS-8141-V 	



3.0L	MOTOR	MODELOS	DESDE / A	JUNTA DE CABEZA	MULTIPLE DE ADMISIÓN O PLENO	
ENGINE	MODELS	FROM / TO	HEAD GASKET	INTAKE		
V6 OHV 12V 1G-576, 577-AA	AEROSTAR	1996/1997	CA-322-G Y CA-323-G	MS-4318		
<b>FS-322-2</b> 			PARA VER IMAGEN DIRIGIRSE A SECCIÓN DE JUNTAS DE CABEZA. TO SEE IMAGE GO TO HEAD GASKET SECTION			
			MULTIPLE DE ESCAPE	PUNTERIAS	CARTER	
			EXHAUST	VALVE COVER	OIL PAN	
			MS-4318-E	VS-3318-1R	OS-1318-1R	
DISTRIBUCIÓN		RETÉN CIGÜEÑAL		SELLOS DE VALVULA		JUNTAS VARIAS
TIMING COVER		CRANK SEAL		STEM SEALS		MISCELLANEOUS
TC-6318		BS-7300		SS-8141-V		

3.5L	MOTOR	MODELOS	DESDE / A	JUNTA DE CABEZA	MULTIPLE DE ADMISIÓN O PLENO	
ENGINE	MODELS	FROM / TO	HEAD GASKET	INTAKE		
V6 OHV 12V	CUSTOM, WAGON PICK-UP.	1954-1964	CA-310-G	MS-4310		
<b>FS-310</b> 						
			MULTIPLE DE ESCAPE	PUNTERIAS	CARTER	
			EXHAUST	VALVE COVER	OIL PAN	
				VS-3310	OS-1310	
DISTRIBUCIÓN		RETÉN CIGÜEÑAL		SELLOS DE VALVULA		JUNTAS VARIAS
TIMING COVER		CRANK SEAL		STEM SEALS		MISCELLANEOUS
TC-6310		BS-7310		SS-8310		



3.8L	MOTOR	MODELOS	DESDE / A	JUNTA DE CABEZA		MULTIPLE DE ADMISIÓN O PLENO
ENGINE	MODELS	FROM / TO	HEAD GASKET		INTAKE	
V6 OHV 12 CARB.	FORD FAIRMONT.	1982/1983	CA-330-G		MS-4330	
DISTRIBUCIÓN		RETÉN CIGÜEÑAL	SELLOS DE VALVULA		JUNTAS VARIAS	
TIMING COVER		CRANK SEAL	STEM SEALS		MISCELLANEOUS	
TC-6330		BS-7360	SS-8330			

3.8L	MOTOR	MODELOS	DESDE / A	JUNTA DE CABEZA		MULTIPLE DE ADMISIÓN O PLENO
ENGINE	MODELS	FROM / TO	HEAD GASKET		INTAKE	
V6 OHV 12 CARB.	COUGAR, THUNDERBIRD	1984/1987	CA-330-G		MS-4330-1	
DISTRIBUCIÓN		RETÉN CIGÜEÑAL	SELLOS DE VALVULA		JUNTAS VARIAS	
TIMING COVER		CRANK SEAL	STEM SEALS		MISCELLANEOUS	
TC-6330-1		BS-7360	SS-8330			





3.8L	MOTOR	MODELOS	DESDE / A	JUNTA DE CABEZA	MULTIPLE DE ADMISIÓN O PLENO
ENGINE	MODELS	FROM / TO	HEAD GASKET	INTAKE	
V6 OHV 12	COUGAR, THUNDERBIRD SUPERCHARGED	1989/1993	CA-330-G 	MS-4330-2 	
FS-330-3 			MULTIPLE DE ESCAPE EXHAUST	PUNTERIAS VALVE COVER	CARTER OIL PAN
TC-6330-2 			MS-4330-E 	VS-3330-1R 	OS-1330-2 
DISTRIBUCIÓN TIMING COVER	RETÉN CIGÜEÑAL CRANK SEAL	SS-8330 	JUNTAS VARIAS MISCELLANEOUS		

3.8L	MOTOR	MODELOS	DESDE / A	JUNTA DE CABEZA	MULTIPLE DE ADMISIÓN O PLENO
ENGINE	MODELS	FROM / TO	HEAD GASKET	INTAKE	
V6 OHV 12V	TAURUS, CONTINENTAL, SABLE	1994/1995	CA-330-G 	MS-4330-4 	
FS-330-4 			MULTIPLE DE ESCAPE EXHAUST	PUNTERIAS VALVE COVER	CARTER OIL PAN
TC-6330-2 			MS-4330-E 	VS-3330-2R 	OS-1330-2 
DISTRIBUCIÓN TIMING COVER	RETÉN CIGÜEÑAL CRANK SEAL	SS-8330 	JUNTAS VARIAS MISCELLANEOUS		





3.8L	MOTOR	MODELOS	DESDE / A
ENGINE		MODELS	FROM / TO
V6 OHV 12V MPFI		WINDSTAR.	1994/1995

FS-332

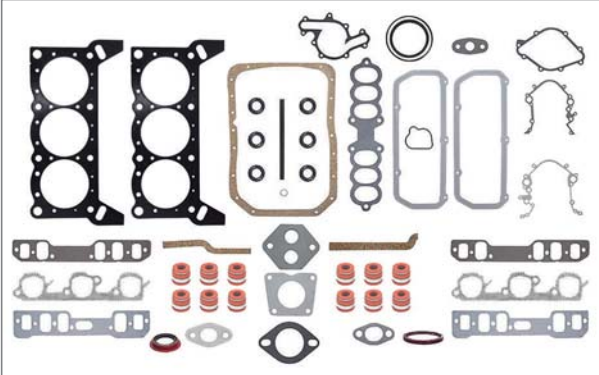

JUNTA DE CABEZA
HEAD GASKET
CA-332-G

MÚLTIPLE DE ADMISIÓN O PLENO
INTAKE
MS-4330-4

MÚLTIPLE DE ESCAPE
EXHAUST
MS-4330-E

PUNTERIAS
VALVE COVER
VS-3330-1R

CARTER
OIL PAN
OS-1330-2

DISTRIBUCIÓN
TIMING COVER
TC-6330-2



RETÉN CIGÜEÑAL
CRANK SEAL
BS-7305



SELLOS DE VALVULA
STEM SEALS
SS-8330



JUNTAS VARIAS
MISCELLANEOUS

3.8L	MOTOR	MODELOS	DESDE / A
ENGINE		MODELS	FROM / TO
V6 OHV 12V MPFI		TAURUS, CONTINENTAL, SABLE	1989/1993

FS-332-1

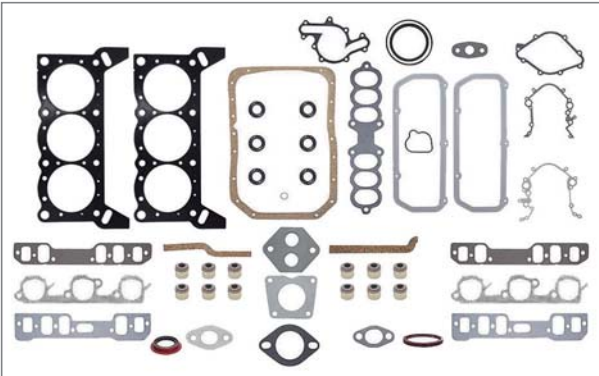

JUNTA DE CABEZA
HEAD GASKET
CA-332-G

MÚLTIPLE DE ADMISIÓN O PLENO
INTAKE
MS-4330-2

MÚLTIPLE DE ESCAPE
EXHAUST
MS-4330-1E

PUNTERIAS
VALVE COVER
VS-3330-1R

CARTER
OIL PAN
OS-1330-2

DISTRIBUCIÓN
TIMING COVER
TC-6330-2



RETÉN CIGÜEÑAL
CRANK SEAL
BS-7305



SELLOS DE VALVULA
STEM SEALS
SS-8330-V



JUNTAS VARIAS
MISCELLANEOUS



3.8L	MOTOR	MODELOS	DESDE / A	JUNTA DE CABEZA	MULTIPLE DE ADMISIÓN O PLENO
ENGINE	MODELS	FROM / TO	HEAD GASKET	INTAKE	
V6 OHV 12V MPFI	AUTOS ,WINDSTAR	1994/1995	CA-332-G 	MS-4330-2 	
FS-332-2 			MULTIPLE DE ESCAPE EXHAUST	PUNTERIAS VALVE COVER	CARTER OIL PAN
DISTRIBUCIÓN TIMING COVER			MS-4330-1E 	VS-3330-2R 	OS-1330-2 
TC-6330-2 			RETÉN CIGÜEÑAL CRANK SEAL	SELLOS DE VALVULA STEM SEALS	JUNTAS VARIAS MISCELLANEOUS
BS-7305 			SS-8305-16V 		

3.8L	MOTOR	MODELOS	DESDE / A	JUNTA DE CABEZA	MULTIPLE DE ADMISIÓN O PLENO
ENGINE	MODELS	FROM / TO	HEAD GASKET	INTAKE	
V6 OHV 12V VIN 2,4	WINDSTAR, ECO-NOLINE.	1997/1998	CA-341-G Y CA-342-G  PARA VER IMAGEN DIRIGIRSE A SECCIÓN DE JUNTAS DE CABEZA. TO SEE IMAGE GO TO HEAD GASKET SECTION	MS-4341 	
FS-341 			MULTIPLE DE ESCAPE EXHAUST	PUNTERIAS VALVE COVER	CARTER OIL PAN
DISTRIBUCIÓN TIMING COVER			MS-4341-E 	VS-3330-2R 	OS-1338 
TC-6330-2 			RETÉN CIGÜEÑAL CRANK SEAL	SELLOS DE VALVULA STEM SEALS	JUNTAS VARIAS MISCELLANEOUS
BS-7360 			SV-8305-1V 		



3.8L	MOTOR	MODELOS	DESDE / A	JUNTA DE CABEZA	MULTIPLE DE ADMISIÓN O PLENO
ENGINE	MODELS	FROM / TO	HEAD GASKET	INTAKE	
V6 OHV 12V	WINDSTAR, F-150.	1997/1998	CA-342-G Y CA-341-G  PARA VER IMAGEN DIRIGIRSE A SECCIÓN DE JUNTAS DE CABEZA.  TO SEE IMAGE GO TO HEAD GASKET SECTION	MS-4341-1 	
FS-341-1 			<b>MULTIPLE DE ESCAPE</b> EXHAUST MS-4341-E 	<b>PUNTERIAS</b> VALVE COVER VS-3330-2R 	<b>CARTER</b> OIL PAN OS-1338 
<b>DISTRIBUCIÓN</b> TIMING COVER TC-6330-2 	<b>RETÉN CIGÜEÑAL</b> CRANK SEAL BS-7360 	<b>SELLOS DE VALVULA</b> STEM SEALS SS-8341-V 	<b>JUNTAS VARIAS</b> MISCELLANEOUS		

3.8L	MOTOR	MODELOS	DESDE / A	JUNTA DE CABEZA	MULTIPLE DE ADMISIÓN O PLENO
ENGINE	MODELS	FROM / TO	HEAD GASKET	INTAKE	
V6 OHV 12V	WINDSTAR ,F-150, ECONOLINE	1997/1998	CA-341-G Y CA-342-G  PARA VER IMAGEN DIRIGIRSE A SECCIÓN DE JUNTAS DE CABEZA.  TO SEE IMAGE GO TO HEAD GASKET SECTION	MS-4341-1 	
FS-341-2 			<b>MULTIPLE DE ESCAPE</b> EXHAUST MS-4341-E 	<b>PUNTERIAS</b> VALVE COVER VS-3330-2R 	<b>CARTER</b> OIL PAN OS-1338 
<b>DISTRIBUCIÓN</b> TIMING COVER TC-6330-2 	<b>RETÉN CIGÜEÑAL</b> CRANK SEAL BS-7360 	<b>SELLOS DE VALVULA</b> STEM SEALS SS-8331-1V 	<b>JUNTAS VARIAS</b> MISCELLANEOUS		













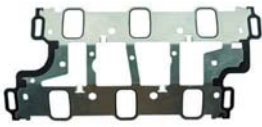
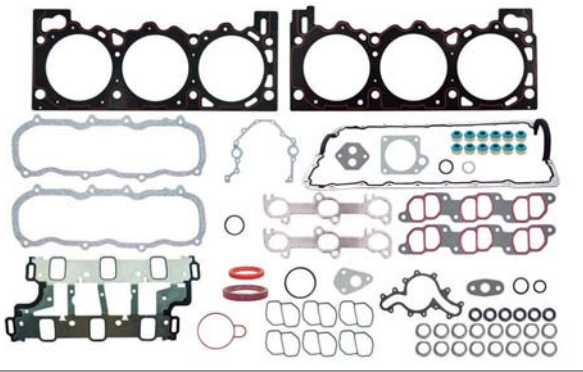









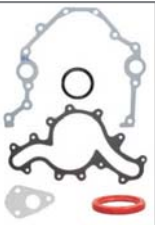

3.8L	MOTOR	MODELOS	DESDE / A	JUNTA DE CABEZA	MULTIPLE DE ADMISIÓN O PLENO
ENGINE	MODELS	FROM / TO	HEAD GASKET	INTAKE	
V6 OHV 12V	WINDSTAR, F-150, ECONOLINE	2001/2004	<p>CA-341-G Y CA-342-G</p> <p>PARA VER IMAGEN DIRIGIRSE A SECCIÓN DE JUNTAS DE CABEZA.</p> <p>TO SEE IMAGE GO TO HEAD GASKET SECTION</p>	<p>MS-4341-1</p>	
<p><b>FS-341-3</b></p>			<p>MULTIPLE DE ESCAPE</p> <p>EXHAUST</p> <p>MS-4341-E</p>	<p>PUNTERIAS</p> <p>VALVE COVER</p> <p>VS-3330-2R</p>	<p>CARTER</p> <p>OIL PAN</p> <p>OS-1338</p>
<p>DISTRIBUCIÓN</p> <p>TIMING COVER</p> <p>TC-6330-2</p>	<p>RETÉN CIGÜEÑAL</p> <p>CRANK SEAL</p> <p>BS-7360</p>	<p>SELLOS DE VALVULA</p> <p>STEM SEALS</p> <p>SS-8341-V</p>	<p>JUNTAS VARIAS</p> <p>MISCELLANEOUS</p>		

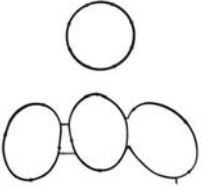
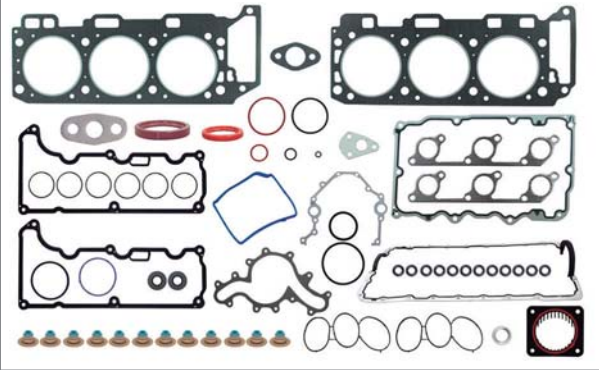
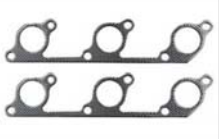
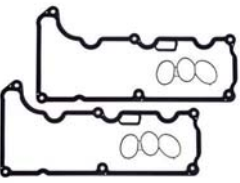
4.0L	MOTOR	MODELOS	DESDE / A	JUNTA DE CABEZA	MULTIPLE DE ADMISIÓN O PLENO
ENGINE	MODELS	FROM / TO	HEAD GASKET	INTAKE	
V6 OHV 12V VIN X	EXPLORER, RANGER.	1990/1994	<p>CA-335-G Y CA-336-G</p> <p>PARA VER IMAGEN DIRIGIRSE A SECCIÓN DE JUNTAS DE CABEZA.</p> <p>TO SEE IMAGE GO TO HEAD GASKET SECTION</p>	<p>MS-4335-A</p>	
<p><b>FS-335</b></p>			<p>MULTIPLE DE ESCAPE</p> <p>EXHAUST</p> <p>MS-4335-E</p>	<p>PUNTERIAS</p> <p>VALVE COVER</p> <p>VS-3335</p>	<p>CARTER</p> <p>OIL PAN</p> <p>OS-1335-1R</p>
<p>DISTRIBUCIÓN</p> <p>TIMING COVER</p> <p>TC-6335</p>	<p>RETÉN CIGÜEÑAL</p> <p>CRANK SEAL</p> <p>BS-7315</p>	<p>SELLOS DE VALVULA</p> <p>STEM SEALS</p> <p>SV-8335-V</p>	<p>JUNTAS VARIAS</p> <p>MISCELLANEOUS</p>		

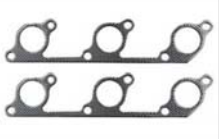
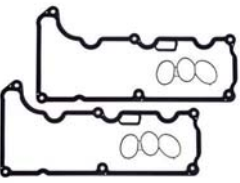

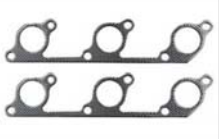
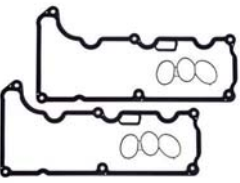

4.0L	MOTOR	MODELOS	DESDE / A	JUNTA DE CABEZA	MULTIPLE DE ADMISIÓN O PLENO							
ENGINE	MODELS	FROM / TO	HEAD GASKET	INTAKE								
V6 OHV 12V VIN X	AEROSTAR, EXPLORER, RANGER	1997/2000	CA-337-G Y CA-338-G  PARA VER IMAGEN DIRIGIRSE A SECCIÓN DE JUNTAS DE CABEZA.  TO SEE IMAGE GO TO HEAD GASKET SECTION	MS-4335-1A 								
FS-335-1 			<table border="1"> <tr> <th>MULTIPLE DE ESCAPE</th> <th>PUNTERIAS</th> <th>CARTER</th> </tr> <tr> <th>EXHAUST</th> <th>VALVE COVER</th> <th>OIL PAN</th> </tr> <tr> <td>MS-4335-E </td> <td>VS-3335-1R </td> <td>OS-1335-1R </td> </tr> </table>	MULTIPLE DE ESCAPE	PUNTERIAS	CARTER	EXHAUST	VALVE COVER	OIL PAN	MS-4335-E 	VS-3335-1R 	OS-1335-1R 
MULTIPLE DE ESCAPE	PUNTERIAS	CARTER										
EXHAUST	VALVE COVER	OIL PAN										
MS-4335-E 	VS-3335-1R 	OS-1335-1R 										
DISTRIBUCIÓN TIMING COVER	RETÉN CIGÜEÑAL CRANK SEAL	SELLOS DE VALVULA STEM SEALS	JUNTAS VARIAS MISCELLANEOUS									
TC-6335 	BS-7315 	SV-8335-V 										

4.0L	MOTOR	MODELOS	DESDE / A	JUNTA DE CABEZA	MULTIPLE DE ADMISIÓN O PLENO							
ENGINE	MODELS	FROM / TO	HEAD GASKET	INTAKE								
V6 OHV 12V VIN E	EXPLORER, MOUNTAINNER.	1997/2001	CA-337-G Y CA-338-G  PARA VER IMAGEN DIRIGIRSE A SECCIÓN DE JUNTAS DE CABEZA.  TO SEE IMAGE GO TO HEAD GASKET SECTION	MS-4337 								
FS-337-G 			<table border="1"> <tr> <th>MULTIPLE DE ESCAPE</th> <th>PUNTERIAS</th> <th>CARTER</th> </tr> <tr> <th>EXHAUST</th> <th>VALVE COVER</th> <th>OIL PAN</th> </tr> <tr> <td>MS-4337-E </td> <td>VS-3337-1R </td> <td>OS-1335-1R </td> </tr> </table>	MULTIPLE DE ESCAPE	PUNTERIAS	CARTER	EXHAUST	VALVE COVER	OIL PAN	MS-4337-E 	VS-3337-1R 	OS-1335-1R 
MULTIPLE DE ESCAPE	PUNTERIAS	CARTER										
EXHAUST	VALVE COVER	OIL PAN										
MS-4337-E 	VS-3337-1R 	OS-1335-1R 										
DISTRIBUCIÓN TIMING COVER	RETÉN CIGÜEÑAL CRANK SEAL	SELLOS DE VALVULA STEM SEALS	JUNTAS VARIAS MISCELLANEOUS									
TC-6337 	BS-7315 	SS-8337-V 										



4.1L	MOTOR	MODELOS	DESDE / A	JUNTA DE CABEZA	MÚLTIPLE DE ADMISIÓN O PLENO
ENGINE	MODELS	FROM / TO	HEAD GASKET	INTAKE	
6L OHV 12V	AUTOS CAMIONES	1969/1980	CA-320-G	MS-4320	
<b>FS-320-1</b> 					
			MÚLTIPLE DE ESCAPE	PUNTERIAS	CARTER
			EXHAUST	VALVE COVER	OIL PAN
			MS-4320	VS-3320	OS-1320
DISTRIBUCIÓN		RETÉN CIGÜEÑAL	SELLOS DE VALVULA		JUNTAS VARIAS
TIMING COVER		CRANK SEAL	STEM SEALS		MISCELLANEOUS
TC-6320		BS-7320	SS-8365		

4.6L	MOTOR	MODELOS	DESDE / A	JUNTA DE CABEZA	MÚLTIPLE DE ADMISIÓN O PLENO
ENGINE	MODELS	FROM / TO	HEAD GASKET	INTAKE	
V8 SOHC 16V TRITON ROMEO	C.VICTORIA, CONTINENTAL, GRAND MARQUIS.	1991/1994	CA-356-ML Y CA-357-ML	MS-4357	
<b>FS-356</b> 			<p>PARA VER IMAGEN DIRIGIRSE A SECCIÓN DE JUNTAS DE CABEZA.</p> <p>TO SEE IMAGE GO TO HEAD GASKET SECTION</p>		
			MÚLTIPLE DE ESCAPE	PUNTERIAS	CARTER
			EXHAUST	VALVE COVER	OIL PAN
			MS-4357-E	VS-3356-R	OS-1357-NS
DISTRIBUCIÓN		RETÉN CIGÜEÑAL	SELLOS DE VALVULA		JUNTAS VARIAS
TIMING COVER		CRANK SEAL	STEM SEALS		MISCELLANEOUS
TC-6356		BS-7360	SS-8356-V		









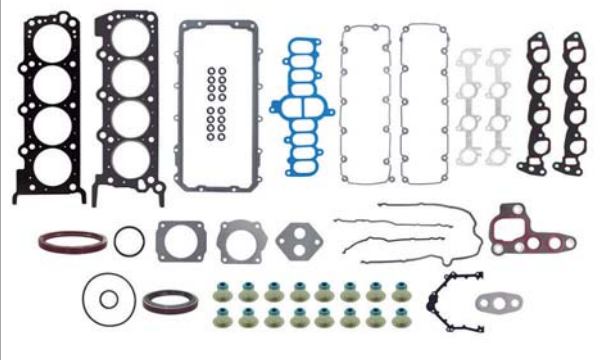
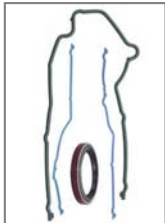

4.6L	MOTOR	MODELOS	DESDE / A	JUNTA DE CABEZA	MULTIPLE DE ADMISIÓN O PLENO	
ENGINE	MODELS	FROM / TO	HEAD GASKET	INTAKE		
V8 SOHC 16V TRITON	MUSTANG , GRAND MARQUIS.	1995/1998	CA-356-G Y CA-357-G  PARA VER IMAGEN DIRIGIRSE A SECCIÓN DE JUNTAS DE CABEZA.  TO SEE IMAGE GO TO HEAD GASKET SECTION	MS-4357 		
FS-356-1 			MULTIPLE DE ESCAPE EXHAUST	PUNTERIAS VALVE COVER	CARTER OIL PAN	
			MS-4357-E 	VS-3356-R 	OS-1357-NS 	
DISTRIBUCIÓN TIMING COVER		RETÉN CIGÜEÑAL CRANK SEAL		SELLOS DE VALVULA STEM SEALS	JUNTAS VARIAS MISCELLANEOUS	
TC-6356		BS-7360	SS-8357-V 			

4.6L	MOTOR	MODELOS	DESDE / A	JUNTA DE CABEZA	MULTIPLE DE ADMISIÓN O PLENO	
ENGINE	MODELS	FROM / TO	HEAD GASKET	INTAKE		
V8 SOHC 16V TRITON	F-250 PICK-UP	1996/1999	CA-356-G Y CA-357-G  PARA VER IMAGEN DIRIGIRSE A SECCIÓN DE JUNTAS DE CABEZA.  TO SEE IMAGE GO TO HEAD GASKET SECTION	MS-4357-NS1 		
FS-356-2 			MULTIPLE DE ESCAPE EXHAUST	PUNTERIAS VALVE COVER	CARTER OIL PAN	
			MS-4357-E 	VS-3356-R 	OS-1357-NS 	
DISTRIBUCIÓN TIMING COVER		RETÉN CIGÜEÑAL CRANK SEAL		SELLOS DE VALVULA STEM SEALS	JUNTAS VARIAS MISCELLANEOUS	
TC-6356		BS-7360	SS-8357-V 			



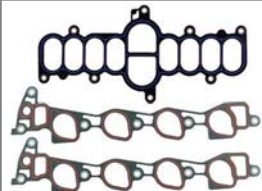
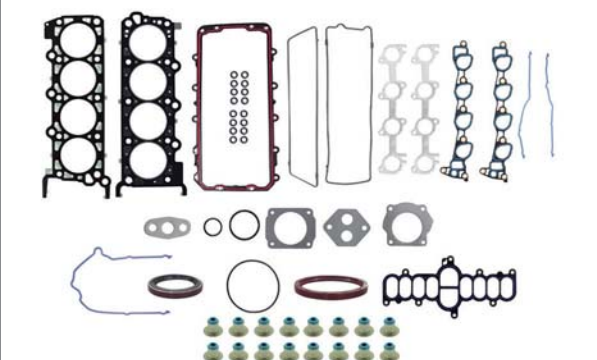
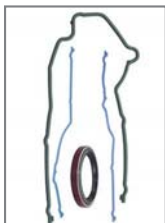

4.6L	MOTOR	MODELOS	DESDE / A	JUNTA DE CABEZA	MULTIPLE DE ADMISIÓN O PLENO		
ENGINE	MODELS	FROM / TO	HEAD GASKET	INTAKE			
V8 SOHC 16V TRITON	F-150, F-250, LOBO TRUCKS	1997/1999	CA-356-E Y CA-357-G	MS-4357-NS1			
<b>FS-356-3</b> 			<p>PARA VER IMAGEN DIRIGIRSE A SECCIÓN DE JUNTAS DE CABEZA.</p> <p>TO SEE IMAGE GO TO HEAD GASKET SECTION</p>				
<b>DISTRIBUCIÓN</b> TIMING COVER TC-6356 		<b>RETÉN CIGÜEÑAL</b> CRANK SEAL BS-7360 		<b>SELLOS DE VALVULA</b> STEM SEALS SS-8357-V 		<b>JUNTAS VARIAS</b> MISCELLANEOUS 	

4.6L	MOTOR	MODELOS	DESDE / A	JUNTA DE CABEZA	MULTIPLE DE ADMISIÓN O PLENO		
ENGINE	MODELS	FROM / TO	HEAD GASKET	INTAKE			
V8 SOHC 16V TRITON	GRAND MARQUIS, F-150, F250, LOBO.	2000/2003	CA-356-ML Y CA-357-ML	MS-4357-NS17			
<b>FS-356-2E</b> 			<p>PARA VER IMAGEN DIRIGIRSE A SECCIÓN DE JUNTAS DE CABEZA.</p> <p>TO SEE IMAGE GO TO HEAD GASKET SECTION</p>				
<b>DISTRIBUCIÓN</b> TIMING COVER TC-6356 		<b>RETÉN CIGÜEÑAL</b> CRANK SEAL BS-7360 		<b>SELLOS DE VALVULA</b> STEM SEALS SS-8357-V 		<b>JUNTAS VARIAS</b> MISCELLANEOUS 	





4.6L	MOTOR	MODELOS	DESDE / A	JUNTA DE CABEZA	MULTIPLE DE ADMISIÓN O PLENO															
ENGINE	MODELS	FROM / TO	HEAD GASKET	INTAKE																
V8 SOHC 16V TRITON	GRAND MARQUIS, F-150, F250, LOBO.	1997/1999	CA-356-ML Y CA-357-ML  PARA VER IMAGEN DIRIGIRSE A SECCIÓN DE JUNTAS DE CABEZA.  TO SEE IMAGE GO TO HEAD GASKET SECTION	MS-4357-NS11 																
FS-356-4 			<table border="1"> <tr> <th>MULTIPLE DE ESCAPE</th> <th>PUNTERIAS</th> <th>CARTER</th> </tr> <tr> <th>EXHAUST</th> <th>VALVE COVER</th> <th>OIL PAN</th> </tr> <tr> <td>MS-4357-E </td> <td>VS-3357-R </td> <td>OS-1357-NS </td> </tr> </table>	MULTIPLE DE ESCAPE	PUNTERIAS	CARTER	EXHAUST	VALVE COVER	OIL PAN	MS-4357-E 	VS-3357-R 	OS-1357-NS 								
MULTIPLE DE ESCAPE	PUNTERIAS	CARTER																		
EXHAUST	VALVE COVER	OIL PAN																		
MS-4357-E 	VS-3357-R 	OS-1357-NS 																		
<table border="1"> <tr> <th>DISTRIBUCIÓN</th> <td rowspan="2"></td> <th>RETÉN CIGÜEÑAL</th> <td rowspan="2"></td> <th>SELLOS DE VALVULA</th> <td rowspan="2"></td> <th>JUNTAS VARIAS</th> <td rowspan="2"></td> </tr> <tr> <th>TIMING COVER</th> <th>CRANK SEAL</th> <th>STEM SEALS</th> <th>MISCELLANEOUS</th> </tr> <tr> <td>TC-6356</td> <td></td> <td>BS-7360</td> <td></td> <td>SS-8357-V</td> <td></td> <td></td> <td></td> </tr> </table>	DISTRIBUCIÓN		RETÉN CIGÜEÑAL		SELLOS DE VALVULA		JUNTAS VARIAS		TIMING COVER	CRANK SEAL	STEM SEALS	MISCELLANEOUS	TC-6356		BS-7360		SS-8357-V			
DISTRIBUCIÓN			RETÉN CIGÜEÑAL				SELLOS DE VALVULA			JUNTAS VARIAS										
TIMING COVER		CRANK SEAL	STEM SEALS	MISCELLANEOUS																
TC-6356		BS-7360		SS-8357-V																

5.0L	MOTOR	MODELOS	DESDE / A	JUNTA DE CABEZA	MULTIPLE DE ADMISIÓN O PLENO															
ENGINE	MODELS	FROM / TO	HEAD GASKET	INTAKE																
V8 OHV 16V	BRONCO, CUSTOM, ECONOLINE, MUSTANG	1962/1978	CA-360-G  	MS-4365-1 																
FS-360-1 			<table border="1"> <tr> <th>MULTIPLE DE ESCAPE</th> <th>PUNTERIAS</th> <th>CARTER</th> </tr> <tr> <th>EXHAUST</th> <th>VALVE COVER</th> <th>OIL PAN</th> </tr> <tr> <td>MS-4360-E </td> <td>VS-3360 </td> <td>OS-1360 </td> </tr> </table>	MULTIPLE DE ESCAPE	PUNTERIAS	CARTER	EXHAUST	VALVE COVER	OIL PAN	MS-4360-E 	VS-3360 	OS-1360 								
MULTIPLE DE ESCAPE	PUNTERIAS	CARTER																		
EXHAUST	VALVE COVER	OIL PAN																		
MS-4360-E 	VS-3360 	OS-1360 																		
<table border="1"> <tr> <th>DISTRIBUCIÓN</th> <td rowspan="2"></td> <th>RETÉN CIGÜEÑAL</th> <td rowspan="2"></td> <th>SELLOS DE VALVULA</th> <td rowspan="2"></td> <th>JUNTAS VARIAS</th> <td rowspan="2"></td> </tr> <tr> <th>TIMING COVER</th> <th>CRANKS SEAL</th> <th>STEM SEALS</th> <th>MISCELLANEOUS</th> </tr> <tr> <td>TC-6360</td> <td></td> <td>BS-7321</td> <td></td> <td>SS-8365</td> <td></td> <td></td> <td></td> </tr> </table>	DISTRIBUCIÓN		RETÉN CIGÜEÑAL		SELLOS DE VALVULA		JUNTAS VARIAS		TIMING COVER	CRANKS SEAL	STEM SEALS	MISCELLANEOUS	TC-6360		BS-7321		SS-8365			
DISTRIBUCIÓN			RETÉN CIGÜEÑAL				SELLOS DE VALVULA			JUNTAS VARIAS										
TIMING COVER		CRANKS SEAL	STEM SEALS	MISCELLANEOUS																
TC-6360		BS-7321		SS-8365																



5.0L	MOTOR	MODELOS	DESDE / A	JUNTA DE CABEZA		MÚLTIPLE DE ADMISIÓN O PLENO
ENGINE	MODELS	FROM / TO	HEAD GASKET		INTAKE	
V8 OHV 16V	BRONCO, CUSTOM, ECONOLINE, MUSTANG	1979/1982	CA-360-G		MS-4365-2	
<b>FS-360-2</b> 						
<b>DISTRIBUCIÓN</b> TIMING COVER TC-6365 		<b>RETÉN CIGÜEÑAL</b> CRANK SEAL BS-7321 	<b>SELLOS DE VALVULA</b> STEM SEALS SS-8365 	<b>PUNTERIAS</b> VALVE COVER VS-3360 	<b>CARTER</b> OIL PAN OS-1360 	<b>JUNTAS VARIAS</b> MISCELLANEOUS 

5.0L	MOTOR	MODELOS	DESDE / A	JUNTA DE CABEZA		MÚLTIPLE DE ADMISIÓN O PLENO
ENGINE	MODELS	FROM / TO	HEAD GASKET		INTAKE	
V8 OHV 16V 260,289,302,335,351,351W	AUTOS Y CAMIONES	1982/1985	CA-360-G		MS-4365-1	
<b>FS-360-3</b> 						
<b>DISTRIBUCIÓN</b> TIMING COVER TC-6365 		<b>RETÉN CIGÜEÑAL</b> CRANK SEAL BS-7360 	<b>SELLOS DE VALVULA</b> STEM SEALS SS-8365 	<b>PUNTERIAS</b> VALVE COVER VS-3360 	<b>CARTER</b> OIL PAN OS-1360 	<b>JUNTAS VARIAS</b> MISCELLANEOUS 



5.0L	MOTOR	MODELOS	DESDE / A	JUNTA DE CABEZA		MULTIPLE DE ADMISIÓN O PLENO
ENGINE	MODELS	FROM / TO	HEAD GASKET		INTAKE	
V8 OHV 16V ONLY USA ENGINES	GRAND MARQUIS, CROWN VICTORIA	1986/1990	CA-365-G		MS-4361-1	
DISTRIBUCIÓN		RETÉN CIGÜEÑAL	SELLOS DE VALVULA	JUNTAS VARIAS		
TIMING COVER		CRANK SEAL	STEM SEALS	MISCELLANEOUS		
TC-6365		BS-7360				

5.0L	MOTOR	MODELOS	DESDE / A	JUNTA DE CABEZA		MULTIPLE DE ADMISIÓN O PLENO
ENGINE	MODELS	FROM / TO	HEAD GASKET		INTAKE	
V8 OHV 16V EFI	F-250, F-350, COUGAR, THUNDERBIRD	1991/1997	CA-360		MS-4361-2	
DISTRIBUCIÓN		RETÉN CIGÜEÑAL	SELLOS DE VALVULA	JUNTAS VARIAS		
TIMING COVER		CRANK SEAL	STEM SEALS	MISCELLANEOUS		
TC-6365		BS-7360				





5.0L	MOTOR	MODELOS	DESDE / A	JUNTA DE CABEZA	MÚLTIPLE DE ADMISIÓN O PLENO
ENGINE	MODELS	FROM / TO	HEAD GASKET	INTAKE	
V8 OHV 16V EFI	COUGAR, GRAND MARQUIS, F-250,	1991/1997	<b>CA-360-G</b> 	<b>MS-4361-2</b> 	
<b>FS-360-6</b> 			<b>MÚLTIPLE DE ESCAPE</b> <b>EXHAUST</b> <b>MS-4360-E</b> 	<b>PUNTERIAS</b> <b>VALVE COVER</b> <b>VS-3360-R</b> 	<b>CARTER</b> <b>OIL PAN</b> <b>OS-1360-1R</b> 
<b>DISTRIBUCIÓN</b> <b>TIMING COVER</b> <b>TC-6365</b> 	<b>RETÉN CIGÜEÑAL</b> <b>CRANK SEAL</b> <b>BS-7300</b> 	<b>SELLOS DE VALVULA</b> <b>STEM SEALS</b> <b>SS-8305-16V</b> 	<b>JUNTAS VARIAS</b> <b>MISCELLANEOUS</b>		

5.4L	MOTOR	MODELOS	DESDE / A	JUNTA DE CABEZA	MÚLTIPLE DE ADMISIÓN O PLENO
ENGINE	MODELS	FROM / TO	HEAD GASKET	INTAKE	
V8 OHV 16V (332-)352-360-390-410-427-428	AUTOS Y CAMIONES.	1961/1976	<b>CA-355-G</b> 	<b>MS-4355-A</b> 	
<b>FS-355</b> 			<b>MÚLTIPLE DE ESCAPE</b> <b>EXHAUST</b> <b>MS-4355-E</b> 	<b>PUNTERIAS</b> <b>VALVE COVER</b> <b>VS-3355</b> 	<b>CARTER</b> <b>OIL PAN</b> <b>OS-1355</b> 
<b>DISTRIBUCIÓN</b> <b>TIMING COVER</b> <b>TC-6355</b> 	<b>RETÉN CIGÜEÑAL</b> <b>CRANK SEAL</b> <b>BS-7355</b> 	<b>SELLOS DE VALVULA</b> <b>STEM SEALS</b> <b>SS-8355</b> 	<b>JUNTAS VARIAS</b> <b>MISCELLANEOUS</b>		





5.8L	MOTOR	MODELOS	DESDE / A
ENGINE		MODELS	FROM / TO
V8 OHV 16V (351W)		TRUCKS, GALAXIE, GRAND MARQUIS.	1969/1983



JUNTA DE CABEZA	MÚLTIPLE DE ADMISIÓN O PLENO
HEAD GASKET	INTAKE

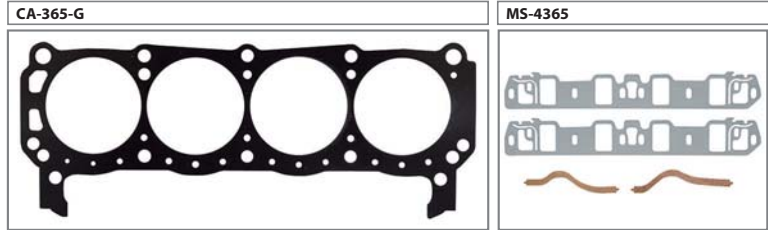

MÚLTIPLE DE ESCAPE	PUNTERIAS	CARTER
EXHAUST	VALVE COVER	OIL PAN



DISTRIBUCIÓN	RETÉN CIGÜEÑAL	SELLOS DE VALVULA	JUNTAS VARIAS
TIMING COVER	CRANK SEAL	STEM SEALS	MISCELLANEOUS
TC-6365	BS-7320	SS-8365	

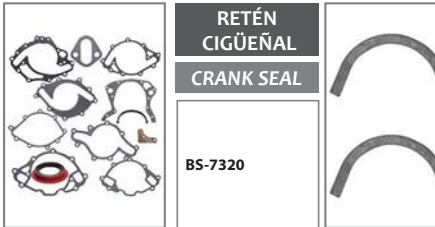

5.8L	MOTOR	MODELOS	DESDE / A
ENGINE		MODELS	FROM / TO
V8 OHV 16V (351W) CARBURADO		AUTOS Y CAMIONES	1975/983

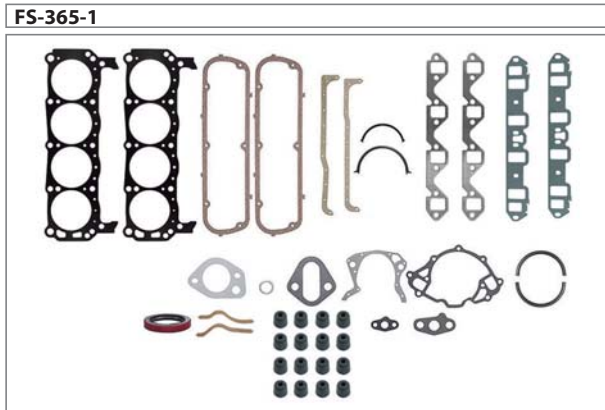

JUNTA DE CABEZA	MÚLTIPLE DE ADMISIÓN O PLENO
HEAD GASKET	INTAKE

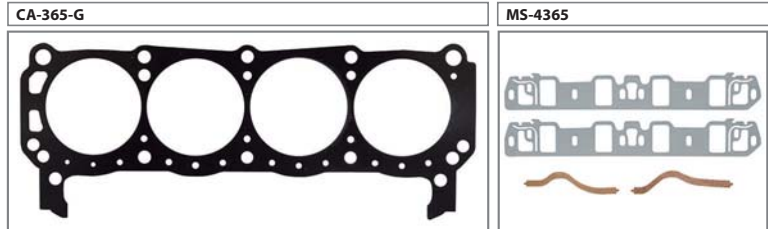

MÚLTIPLE DE ESCAPE	PUNTERIAS	CARTER
EXHAUST	VALVE COVER	OIL PAN

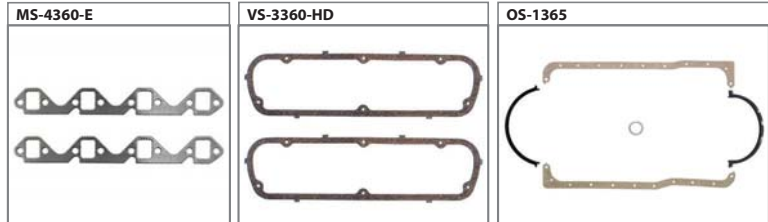

DISTRIBUCIÓN	RETÉN CIGÜEÑAL	SELLOS DE VALVULA	JUNTAS VARIAS
TIMING COVER	CRANK SEAL	STEM SEALS	MISCELLANEOUS
TC-6365	BS-7310	SS-8365	

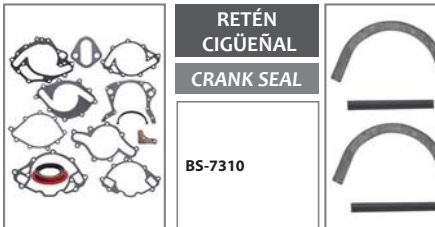



5.8L	MOTOR	MODELOS	DESDE / A	JUNTA DE CABEZA	MULTIPLE DE ADMISIÓN O PLENO
ENGINE	MODELS	FROM / TO	HEAD GASKET	INTAKE	
V8 OHV 16V (351W) (MEXICO 335")	AUTOS Y CAMIONES	1984/1990	CA-365-G	MS-4360-A	
<b>FS-365-2</b> 			 	 	
			MULTIPLE DE ESCAPE	PUNTERIAS	CARTER
			EXHAUST	VALVE COVER	OIL PAN
			MS-4360-E	VS-3360-HD	OS-1365-1R
DISTRIBUCIÓN	RETÉN CIGÜEÑAL		SELLOS DE VALVULA	JUNTAS VARIAS	
TIMING COVER	CRANK SEAL		STEM SEALS	MISCELLANEOUS	
TC-6365	BS-7320	 	SS-8365	 	

5.8L	MOTOR	MODELOS	DESDE / A	JUNTA DE CABEZA	MULTIPLE DE ADMISIÓN O PLENO
ENGINE	MODELS	FROM / TO	HEAD GASKET	INTAKE	
V8 OHV 16V (351W) F.I.	F-250,F-350,MICROBUS	1991/1997	CA-365-G	MS-4365-2	
<b>FS-365-3</b> 			 	 	
			MULTIPLE DE ESCAPE	PUNTERIAS	CARTER
			EXHAUST	VALVE COVER	OIL PAN
			MS-4360-E	VS-3360	OS-1365-1R
DISTRIBUCIÓN	RETÉN CIGÜEÑAL		SELLOS DE VALVULA	JUNTAS VARIAS	
TIMING COVER	CRANK SEAL		STEM SEALS	MISCELLANEOUS	
TC-6365	BS-7325	 	SS-8300	 	 



5.8L	MOTOR	MODELOS	DESDE / A
ENGINE		MODELS	FROM / TO
V8 OHV 16V (351C,400) CARB.		F-150, PICK-UP, TRUCKS.	1970/1982

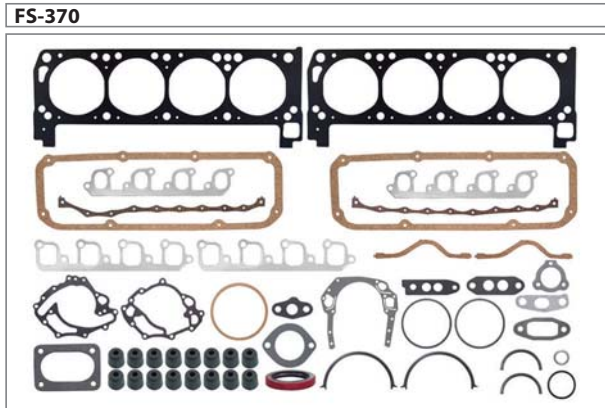

JUNTA DE CABEZA	MULTIPLE DE ADMISIÓN O PLENO
HEAD GASKET	INTAKE

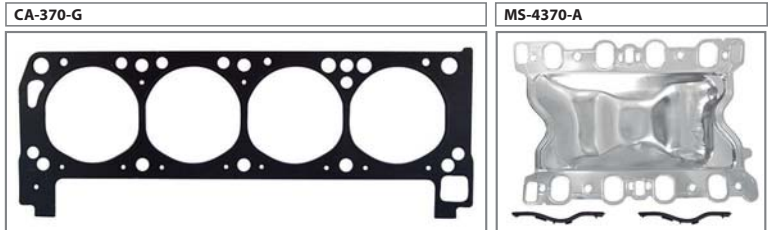

MULTIPLE DE ESCAPE	PUNTERIAS	CARTER
EXHAUST	VALVE COVER	OIL PAN

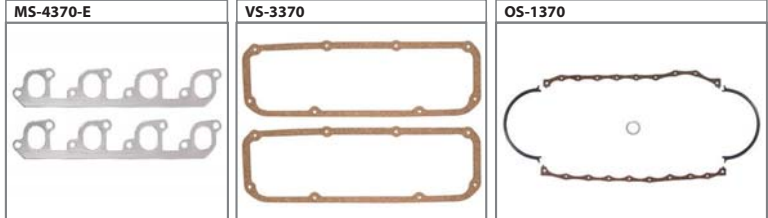

DISTRIBUCIÓN	RETÉN CIGÜEÑAL
TIMING COVER	CRANK SEAL
TC-6370	BS-7370

SELLOS DE VALVULA	JUNTAS VARIAS
STEM SEALS	MISCELLANEOUS
SS-8365	

6.1L	MOTOR	MODELOS	DESDE / A
ENGINE		MODELS	FROM / TO
V8 OHV 16V (370,389 CID)		CAMIONES.	1979/1989

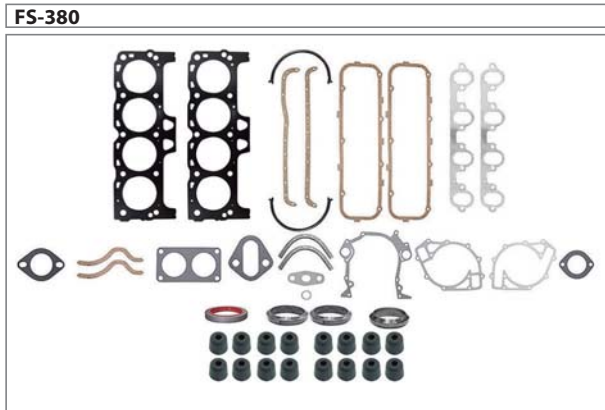

JUNTA DE CABEZA	MULTIPLE DE ADMISIÓN O PLENO
HEAD GASKET	INTAKE



MULTIPLE DE ESCAPE	PUNTERIAS	CARTER
EXHAUST	VALVE COVER	OIL PAN

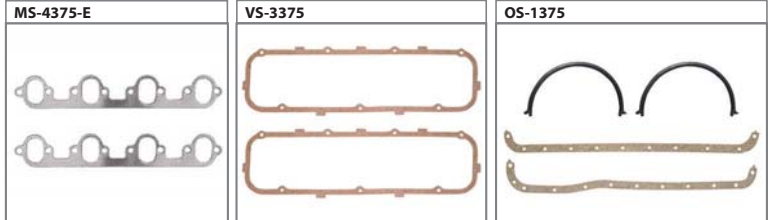

DISTRIBUCIÓN	RETÉN CIGÜEÑAL
TIMING COVER	CRANK SEAL
TC-6376	BS-7142

SELLOS DE VALVULA	JUNTAS VARIAS
STEM SEALS	MISCELLANEOUS
SS-8365	













6.8L	MOTOR	MODELOS	DESDE / A	JUNTA DE CABEZA	MULTIPLE DE ADMISIÓN O PLENO
ENGINE	MODELS	FROM / TO	HEAD GASKET	INTAKE	
V10 OHV 16V TRITON (415CID)	TRUCKS, F-450 SUPER DUTY.	1997/1999	CA-390-G 	MS-4390 	
<b>FS-390</b> 			MULTIPLE DE ESCAPE EXHAUST	PUNTERIAS VALVE COVER	CARTER OIL PAN
			MS-4390-E 	VS-3390-R 	OS-1390 
DISTRIBUCIÓN TIMING COVER		RETÉN CIGÜEÑAL CRANK SEAL		SELLOS DE VALVULA STEM SEALS	JUNTAS VARIAS MISCELLANEOUS
TC-6357		BS-7305		SV-8357-V 	

7.0L	MOTOR	MODELOS	DESDE / A	JUNTA DE CABEZA	MULTIPLE DE ADMISIÓN O PLENO
ENGINE	MODELS	FROM / TO	HEAD GASKET	INTAKE	
V8 OHV 16V (429,460)	GALAXIE, CUSTOM 500, F-350, F-600.	1968/1985	CA-375-G 	MS-4375 	
<b>FS-375</b> 			MULTIPLE DE ESCAPE EXHAUST	PUNTERIAS VALVE COVER	CARTER OIL PAN
			MS-4375-E 	VS-3375 	OS-1375 
DISTRIBUCIÓN TIMING COVER		RETÉN CIGÜEÑAL CRANK SEAL		SELLOS DE VALVULA STEM SEALS	JUNTAS VARIAS MISCELLANEOUS
TC-6375		BS-7142		SS-8365 	





7.5L	MOTOR	MODELOS	DESDE / A	JUNTA DE CABEZA		MÚLTIPLE DE ADMISIÓN O PLENO
ENGINE		MODELS	FROM / TO	HEAD GASKET		INTAKE
V8 OHV 16V (427,460)		GALAXIE, CUSTOM 500, F-350, F-700.	1968/1985	<b>CA-375-G</b> 		<b>MS-4375</b> 
<b>FS-375</b>				<b>MÚLTIPLE DE ESCAPE</b>		<b>PUNTERIAS</b>
				<b>EXHAUST</b>		<b>CARTER</b>
				<b>MS-4375-E</b>		<b>OS-1375</b>
						
				<b>VS-3375</b>		
						
<b>DISTRIBUCIÓN</b>		<b>RETÉN CIGÜEÑAL</b>		<b>SELLOS DE VALVULA</b>		<b>JUNTAS VARIAS</b>
<b>TIMING COVER</b>		<b>CRANK SEAL</b>		<b>STEM SEALS</b>		<b>MISCELLANEOUS</b>
TC-6375		BS-7142		SS-8365		

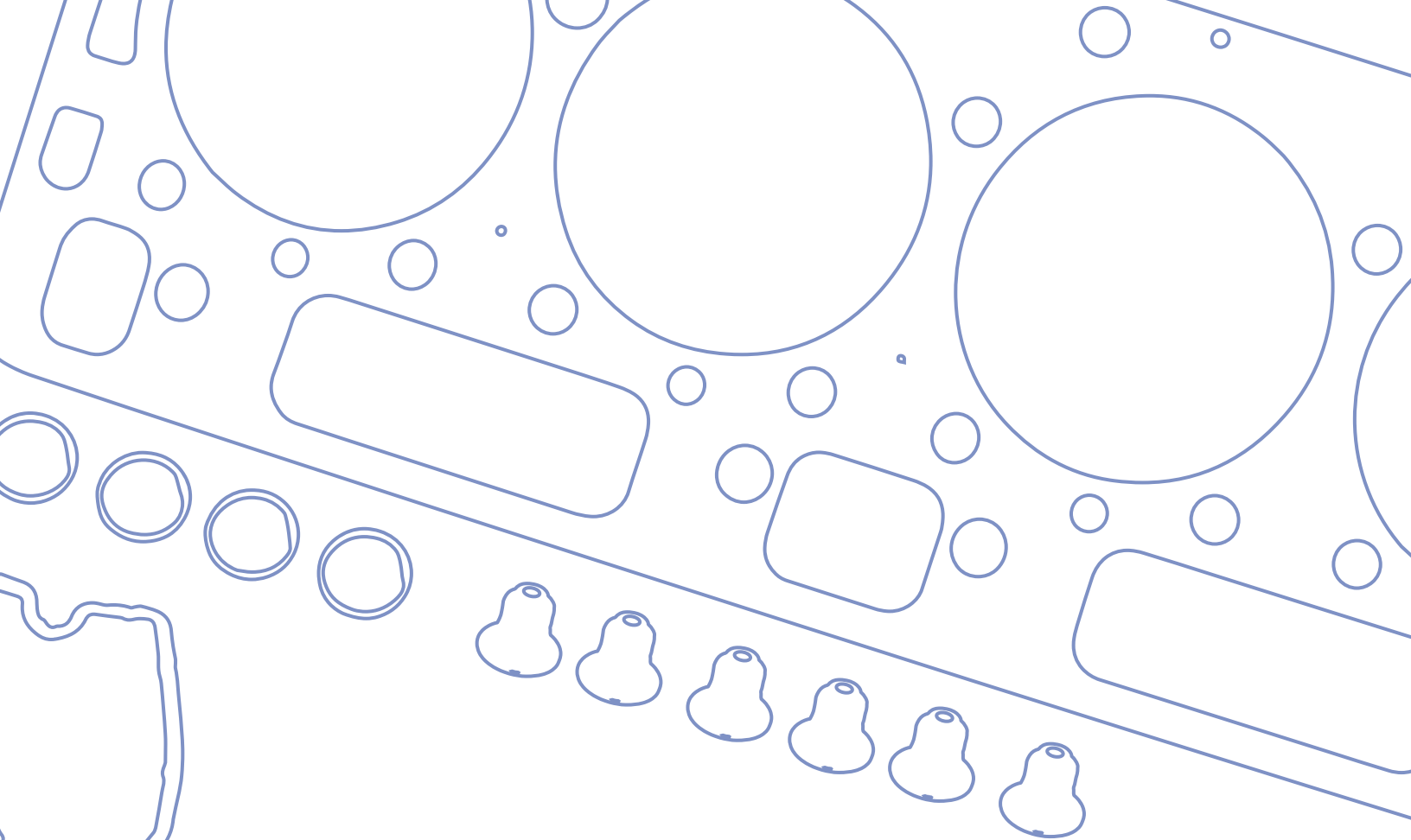

# GENERAL MOTORS

MARCA  
/MAKE

CATÁLOGO DE APLICACIONES / APPLICATION CATALOG

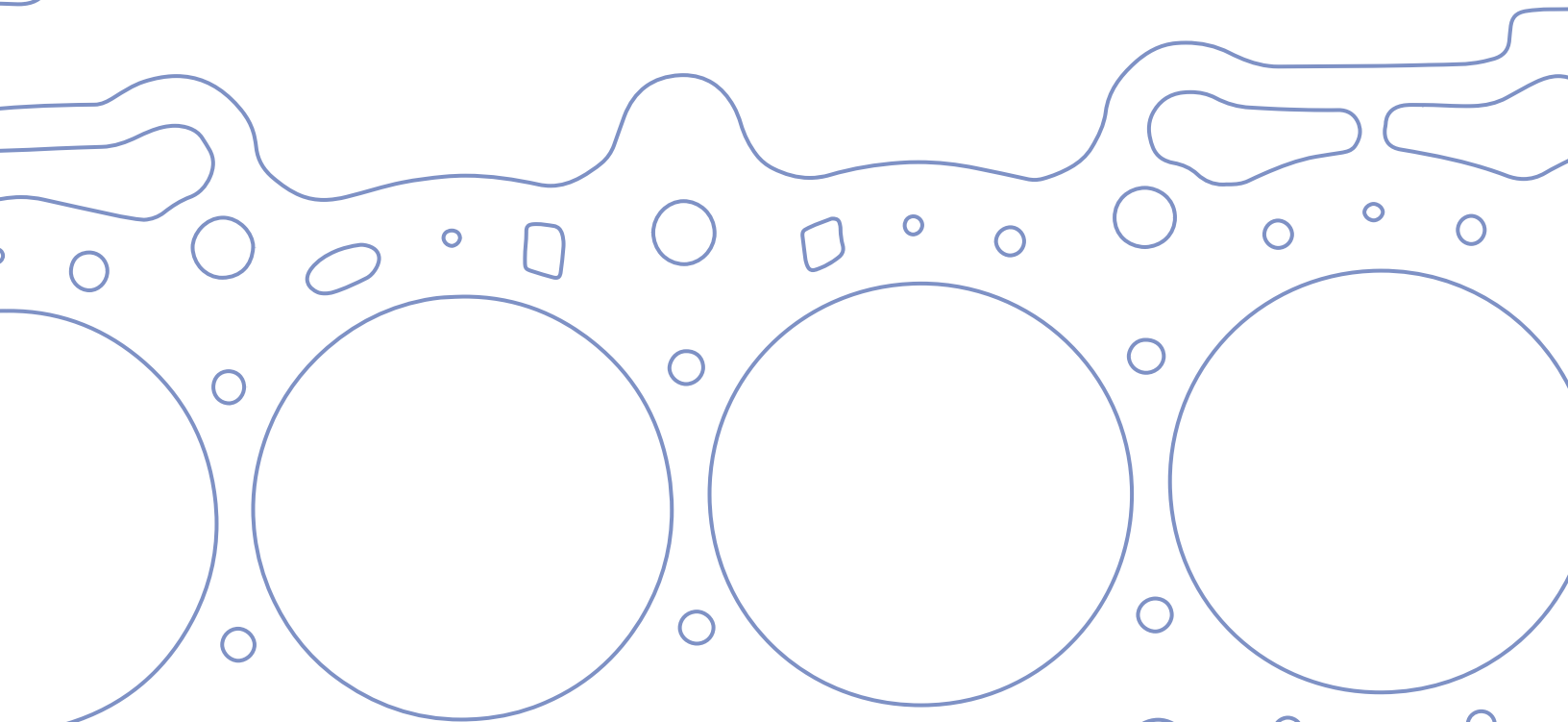





**GENERAL MOTORS**

LITROS	MODELO	AÑO	PÁGINA
LITERS	MODEL	YEAR	PAGE
1.0L	SPRINT, FIREFLY, FORSA.	1985/1988	*
1.0L	GEO METRO, SWIFT.	1989/1997	*
1.0L	MATIZ G2.	2004/2010	97
1.2L	SPARK.	2011/2013	97
1.4L	CHEVY POP, JOY, SWING.	1994/2001	98
1.6L	CHEVY MONZA, PICK-UP.	1996/2012	98
1.6L	AVEO, PONTIAC G3 (CABEZA DE GRAFITO).	2008/2012	99
1.6L	AVEO, PONTIAC G3 (CABEZA DE MLS).	2008/2012	99
1.6L	CHEVY NOVA.	1986/1988	*
1.8L	LUV, ISUZU PICK UP.	1972/1982	*
1.8L	PONTIAC SUNBIRD, J200, OLDSMOBILE FIRENZA.	1982/1986	*
1.8L	ASTRA, ZAFIRA.	2000/2008	*
1.8L	CORSA, PICK-UP TORNADO.	2003/2006	100
1.8L	CORSA, PICK-UP TORNADO.	2007/2010	100
1.8L	CRUZE (CABEZA DE GRAFITO).	2011/2013	101
1.8L	CRUZE, (CABEZA DE MLS).	2011/2013	101
1.9L	S10, BLAZER, ISUZU TROOPER.	1982/1985	*
1.9L	SATURN SL, SL1, SC1, SW1.	1991/1995	102
1.9L	SATURN SC, SC2, SL2, SW2.	1991/1995	102
2.0L	CAVALIER, FIRENZA, SKYHAWK, SUNBIRD.	1983/1987	*
2.0L	CAVALIER AMERICANO.	1985/1986	*
2.0L	CAVALIER USA, BERETTA, CORSICA.	1987/1991	103
2.0L	OPTRA, ASTRA, FORENZA.	2004/2010	*
2.0L	TRACKER, SUZUKI VITARA, AERIO, SX4.	1999/2009	*
2.2L	MEXICO PICK-UP LUV PONTIAC BRASIL.	1998/2005	103
2.2L	CAVALIER USA, BERETTA, CORSICA.	1990/1991	104
2.2L	CAVALIER AMERICANO, CUTTLAS, CENTURY.	1992/1993	104
2.2L	CAVALIER, BUICK CENTURY, PONTIAC SUNFIRE SE.	1994/1997	105
2.2L	PICK UP S-10, SONOMA, ISUZU HOMBRE.	1994/1997	105
2.2L	CAVALIER, S-10, SONOMA.	1998/2002	106
2.2L	ASTRA, ZAFIRA, CAVALIER, MALIBU, HHR, PONTIAC SUNFIRE, GRAND AM.	2001/2008	*
2.3L	BERETTA, PONTIAC GRAND AM, GRAND PRIX, CLUTLASS, SKYLARK.	1987/1991	106
2.4L	PONTIAC SUNFIRE, GRAND AM, CAVALIER, MALIBU.	1997/2002	107
2.4L	ALERO, CAVALIER, MALIBU, PONTIAC GRAND AM, SUNFIRE.	1999/2002	*
2.4L	PONTIAC G4, ASTRA.	2004/2006	*
2.5L	CELEBRITY, CITATION, CJ5, CJ7.	1979/1983	*
2.5L	S10, ASTRO, CELEBRITY, JIMMY, PONTIAC FIERO, GRAND AM.	1987	*
2.5L	S10, ASTRO, CELEBRITY, S15, SAFARI, CUTLASS.	1988/1990	107
2.5L	CELEBRITY, CENTURY, CUTLASS, SONOMA, S10, LUMINA.	1990/1993	108
2.5L	CENTURY, SKYLARK, GRAND AM.	1985/1986	*
2.5L	SKYLARK, SOMERSET, CALAIS, GRAND AM.	1987	*
2.5L	GRAND AM, CUTLASS CALAIS, SKYLARK.	1988	*
2.5L	GRAND AM, CUTLASS CALAIS, SKYLARK.	1989/1991	*
2.7L	VITARA, GRAND VITARA.	2006/2010	*



**GENERAL MOTORS**

LITROS	MODELO	AÑO	PÁGINA
LITERS	MODEL	YEAR	PAGE
2.8L	COLORADO, CANYON.	2004/2006	108
2.8L	CELEBRITY, CITATION, S10, PONTIAC FIREBIRD.	1980/1984	109
2.8L	CUTLASS, CAVALIER, CELEBRITY, CITATION, COMANCHE, WAGONEER.	1985/1986	109
2.8L	CAMIONETA S-10, SONOMA, CELEBRITY.	1987/1993	110
2.8L	MPFI 2a GENERACION, CAVALIER, CUTLASS, EUROSPOET, CENTURY.	1988/1994	110
2.9L	COLORADO, CANYON, ISUZU I-290.	2007/2012	*
3.0L	BUICK REGAL, LeSABRE, RIVIERA, CAPRICE, EL CAMINO, PONTIAC BONNEVILLE, CUTLASS.	1982/1985	*
3.1L	CAVALIER, CUTLASS, CENTURY.	1988/1995	111
3.1L	LUMINA SEDAN, MALIBU.	2000/2003	111
3.1L	CENTURY, LUMINA, MALIBU, GRAND PRIX.	1995/1999	112
3.3L	CENTURY, CUTLASS, GRAND AM, SKYLARK	1990/1993	*
3.4L	MONTE CARLO, LUMINA, GRAND PRIX, CUTLASS.	1991/1997	*
3.4L	VENTURE, IMPALA, MONTE CARLO, TRANS SPORT, AZTEK, GRAND AM.	1996/2003	112
3.5L	BEL AIR, FLEETMASTER, TWO-TEN SERIES, AUTOS Y CAMIONES TODOS.	1937/1953	*
3.5L	COLORADO, CANYON, H3, i-350.	2004/2006	113
3.5L	AURORA, INTRIGUE.	1999/2002	*
3.6L	ACADIA, EQUINOX, MALIBU, PONTIAC G6, G8, TORRENT, CADILLAC CTS, SRX, STS.	2004/2011	*
3.7L	COLORADO, CANYON, ISUZU I-370, HUMMER H3.	2007/2012	*
3.8L	BEL AIR, AUTOS & CAMIONES.	1953/1962	*
3.8L	AUTOS BUICK, CUTLASS, MONTE CARLO, MALIBU.	1977/1982	*
3.8L	MALIBU, IMPALA, CAPRICE, PONTIAC LeMANS.	1980/1984	*
3.8L	PONTIAC GRAND AM, BONNEVILLE, TRANS SPORT.	1991/1993	*
3.8L	ELECTRA, LE SABRE, REATTA, RIVERA.	1988/1990	*
3.8L	GRAND PRIX, MONTE CARLO, LUMINA, IMPALA, BONNEVILLE.	1997/2005	113
3.8L	GRAND PRIX, BONNEVILLE, MONTE CARLO, IMPALA, RIVIERA, (SUPERCARGADOS).	1997/2005	*
4.0L	OLDSMOBILE AURORA.	1995/2003	*
4.1L	AUTOS Y CAMIONES CARBURADOS & TBI.	1963/1992	114
4.1L	AUTOS Y CAMIONES, USA.	1975/1979	*
4.1L	SERIES C10, C20, C30, K10, K20.	1979	*
4.2L	TRAILBLAZER, ENVOY, ASCENDER, BRAVADA (CABEZA DE GRAFITO).	2002/2006	114
4.2L	TRAILBLAZER, ENVOY, ASCENDER, BRAVADA (CABEZA DE MLS).	2002/2006	*
4.3L	ASTRO, PICKUP C10, C20, C1500, C2500, SAFARI, CAPRICE, EL CAMINO.	1985/1990	115
4.3L	ASTRO, PICK UP S10, S15, C1500, C2500, G10, G20, G30, JIMMY, SAFARI (MOTOR TBI).	1986/1992	115
4.3L	ASTRO, SAFARI.	1986/1992	116
4.3L	SONOMA, S-10, S-15, ASTRO, SAFARI, C1500, C2500, K1500, K2500.	1993	116
4.3L	ASTRO, SAFARI, SONOMA, C1500, C2500, G1500, G2500, G3500, JIMMY.	1994/1995	117
4.3L	ASTRO, S10, BLAZER, SAFARI, SONOMA, S-15, JIMMY.	1992/1993	117
4.3L	ASTRO, SAFARI, S-10, BLAZER, JIMMY.	1994/1995	118
4.3L	SAFARI, ASTRO, SONOMA, S-10, JIMMY, SAVANA 1500, SIERRA 1500, SILVERADO 1500, SONORA, EXPRESS VAN, C1500.	1996/2011	118
4.3L	CAPRICE.	1994/1996	119

\* Escanear código QR para consultar en catálogo electrónico o dirígase a [catalogo.dcp.com.mx](http://catalogo.dcp.com.mx).



LITROS	MODELO	AÑO	PÁGINA
LITERS	MODEL	YEAR	PAGE
4.3L	CUTLASS CALAIS, SUPREME, SALON, CRUISER, BROUGHAM.	1977/1982	*
4.6L	CADILLAC DeVILLE, ELdorado, SEVILLE, PONTIAC BONEVILLE.	2000/2001	*
4.8L	AUTOS Y CAMIONES CARBURADOS & TBI.	1963/1992	119
4.8L	K2500, K3500, C2500, C3500.	1963/1989	*
4.8L	CHEYENNE, SILVERADO 1500, 2500, SUBURBAN, YUKON, SIERRA 1500, 2500, TAHOE (CABEZAS DE GRAFITO).	1999/2001	120
4.8L	CHEYENNE, SILVERADO 1500, 2500, SUBURBAN, YUKON, SIERRA 1500, 2500, TAHOE (CABEZAS DE MLS).	1999/2001	120
4.8L	SUBURBAN, SILVERADO 1500, 2500, SIERRA 1500, 2500, YUKON, AVALANCHE, SAVANA, EXPRESS VAN 1500, 2500, SONORA.	2002/2009	121
5.0L	CAMARO, MALIBU, K10, K20, IMPALA, CHEVELLE, CHEVY NOVA, CORVETTE, CAPRICE, MONTE CARLO, SUBURBAN.	1967/1973	*
5.0L	AUTOS Y CAMIONES.	1976/1980	*
5.0L	CARBURADOS, AUTOS Y CAMIONETAS.	1981/1987	*
5.0L	EXPRESS VAN 1500, 2500, C1500, C2500, K1500, K500, SAVANA.	1996/2002	121
5.0L	CAPRICE, MONTE CARLO, C1500, C2500, CAMARO, PONTIAC GRAND PRIX, FIREBIRD, MOTOR TBI.	1987/1995	122
5.0L	CAMARO, FIREBIRD.	1987/1992	122
5.0L	OLDSMOBILE CUTLASS, PONTIAC BONNEVILLE, BUICK RIVIERA, LeSABRE.	1980/1984	*
5.3L	IMPALA, CORVETTE, MALIBU, EL CAMINO, CHEVELLE, CAPRICE, CAMARO, CAMIONETAS PICK UP.	1965/1979	*
5.3L	CHEYENNE, SILVERADO 1500, 2500, SUBURBAN, YUKON, SIERRA 1500, 2500, TAHOE (CABEZAS DE GRAFITO).	1999/2001	123
5.3L	CHEYENNE, SILVERADO 1500, 2500, SUBURBAN, YUKON, SIERRA 1500, 2500, TAHOE (CABEZAS DE MLS).	1999/2001	123
5.3L	SUBURBAN, SILVERADO 1500, 2500, SIERRA 1500, 2500, YUKON, AVALANCHE, SAVANA, EXPRESS VAN 1500, 2500, SONORA.	2002/2009	124
5.7L	MICROBUS, SUBURBAN, C-2500, C-3500, PICK-UP SOLO MEXICO.	1992/1998	124
5.7L	SUBURBAN, YUKON, EXPRESS VAN 1500, 2500, 3500, SILVERADO 1500, 2500, SONORA, TAHOE, ESCALADE.	1996/2002	125
5.7L	CAMARO, MALIBU, K10, K20, IMPALA, CHEVELLE, CHEVY NOVA, CORVETTE, CAPRICE, MONTE CARLO, SUBURBAN.	1967/1973	*
5.7L	MALIBU, MONTE CARLO, IMPALA, CHEVELLE, CORVETTE, CAPRICE, CAMARO, PICK UP C10, C20, C30, SUBURBAN.	1973/1991	125
5.7L	PICK UP K10, K20, K30, C10, C20, C30, SUBURBAN, IMPALA, MICROBUS.	1981/1986	126
5.7L	AUTOS Y CAMIONES USA.	1987/1988	126
5.7L	CAMIONETAS "TBI" C1500, C2500, C3500, V1500, V2500, V3500, K1500, K2500, K3500, YUKON, TAHOE, BLAZER.	1989/1996	127
5.7L	FIREBIRD, CAMARO Z28, CAPRICE.	1992/1997	127
5.7L	CADILLAC SEVILLE.	1976	*
5.7L	OLDSMOBILE OMEGA, CUTLASS, DELTA, SKYLARK, ELECTRA, CENTURY.	1977/1980	*
6.0L	SILVERADO 2500, SIERRA 2500, YUKON, EXPRESS VAN, CARGO VAN, SUBURBAN (CABEZA DE GRAFITO).	1999/2001	128
6.0L	SILVERADO 2500, SIERRA 2500, YUKON, EXPRESS VAN, CARGO VAN,	1999/2001	128



**GENERAL MOTORS**

<b>LITROS</b>	<b>MODELO</b>	<b>AÑO</b>	<b>PÁGINA</b>
<b>LITERS</b>	<b>MODEL</b>	<b>YEAR</b>	<b>PAGE</b>
	SUBURBAN (CABEZAS DE MLS).		
<b>6.0L</b>	SUBURBAN, YUKON, SIERRA 2500, SILVERADO 1500, 2500, 3500, EXPRESS VAN 2500, 3500, CORVETTE, AVALANCHE.	2001/2007	<b>129</b>
<b>6.2L</b>	SUBURBAN 1500, 2500, 3500, PICK UP K1500, 2500, 3500, C1500, C2500, C3500, HUMMER, (DIESEL).	1982/1993	<b>129</b>
<b>6.5L</b>	PICK UP C1500, C2500, C3500, K1500, K2500, K3500, EXPRESS 2500, 3500, SAVANA, YUKON, TAHOE, HUMMER H1, (DIESEL).	1994/2005	<b>130</b>
<b>6.6L</b>	MONTE CARLO, IMPALA, CHEVELLE NOMAD, CAPRICE, BEL AIR, CAMARO, EL CAMINO, PONTIAC FIREBIRD, BONNEVILLE.	1970/1976	*
<b>7.0L</b>	CAMARO, CORVETTE, CAPRICE, IMPALA.	1965/1969	*
<b>7.4L</b>	AUTOS Y CAMIONES.	1970/1980	*
<b>7.4L</b>	PICK UP C1500, C2500, C3500.	1980/1985	*
<b>7.4L</b>	CAMION KODIAK.	1987/1990	*
<b>7.4L</b>	C1500, C2500, C3500, K2500, K3500.	1991/1996	<b>130</b>
<b>7.4L</b>	KODIAK C2500, C3500, K2500, K3500.	1996/2000	<b>131</b>
<b>7.5L</b>	OLDSMOBILE DELTA, CUTLASS, VISTA.	1968/1974	*
<b>8.1L</b>	SILVERADO, 2500HD, 3500, SIERRA 2500, 3500, YUKON, SUBURBAN, AVALANCHE, EXPRESS VAN.	2001/2007	<b>131</b>

\* Escanear código QR para consultar en catálogo electrónico o dirigase a [catalogo.dcp.com.mx](http://catalogo.dcp.com.mx).





1.0L	MOTOR	MODELOS	DESDE / A	JUNTA DE CABEZA	MULTIPLE DE ADMISIÓN O PLENO
ENGINE	MODELS	FROM / TO	HEAD GASKET	INTAKE	
4L SOHC 8V DAEWOO ENGINE	MATIZ G2.	2004/2010	CA-116-G 	MS-4116 	
FS-116 			MULTIPLE DE ESCAPE EXHAUST MS-4116-E 	PUNTERIAS VALVE COVER VS-3116-R 	CARTER OIL PAN
DISTRIBUCIÓN TIMING COVER TC-6116 	RETÉN CIGÜEÑAL CRANK SEAL BS-7116 	SELLOS DE VALVULA STEM SEALS SS-8116-R 	JUNTAS VARIAS MISCELLANEOUS N/A	N/A	

1.2L	MOTOR	MODELOS	DESDE / A	JUNTA DE CABEZA	MULTIPLE DE ADMISIÓN O PLENO
ENGINE	MODELS	FROM / TO	HEAD GASKET	INTAKE	
4L DOHC 16V	SPARK.	2011/2013	CA-119-ML 	MS-4119-A 	
FS-119-ML 			MULTIPLE DE ESCAPE EXHAUST MS-4119-E 	PUNTERIAS VALVE COVER VS-3119-R 	CARTER OIL PAN
DISTRIBUCIÓN TIMING COVER TC-6119 	RETÉN CIGÜEÑAL CRANK SEAL BS-7116 	SELLOS DE VALVULA STEM SEALS SS-8119-V 	JUNTAS VARIAS MISCELLANEOUS N/A	N/A	



1.4L	MOTOR	MODELOS	DESDE / A	JUNTA DE CABEZA		MULTIPLE DE ADMISIÓN O PLENO
ENGINE	MODELS	FROM / TO	HEAD GASKET		INTAKE	
4L SOHC 8V	CHEVY POP, JOY, SWING.	1994/2001	<b>CA-100-G</b> 		<b>MS-4100</b> 	
<b>FS-100</b>						
<b>DISTRIBUCIÓN</b>		<b>RETÉN CIGÜEÑAL</b>		<b>SELLOS DE VALVULA</b>	<b>JUNTAS VARIAS</b>	N/A
<b>TIMING COVER</b>		<b>CRANK SEAL</b>		<b>STEM SEALS</b>	<b>MISCELLANEOUS</b>	
TC-6100		BS-7100	SS-8100-V		N/A	

1.6L	MOTOR	MODELOS	DESDE / A	JUNTA DE CABEZA		MULTIPLE DE ADMISIÓN O PLENO
ENGINE	MODELS	FROM / TO	HEAD GASKET		INTAKE	
4L SOHC 8V	CHEVY MONZA, PICK-UP.	1996/2012	<b>CA-100-1G</b> 		<b>MS-4100-1</b> 	
<b>FS-100-1</b>						
<b>DISTRIBUCIÓN</b>		<b>RETÉN CIGÜEÑAL</b>		<b>SELLOS DE VALVULA</b>	<b>JUNTAS VARIAS</b>	N/A
<b>TIMING COVER</b>		<b>CRANK SEAL</b>		<b>STEM SEALS</b>	<b>MISCELLANEOUS</b>	
TC-6100		BS-7100	SS-8100-V		N/A	



1.6L	MOTOR	MODELOS	DESDE / A	JUNTA DE CABEZA	MULTIPLE DE ADMISIÓN O PLENO
ENGINE	MODELS	FROM / TO	HEAD GASKET	INTAKE	
4L DOHC 16V VIN 6 E-TEC	AVEO, PONTIAC G3 (CABEZA DE GRAFITO).	2008/2012	CA-102-1G	MS-4102-1A	
<b>FS-102-1G</b> 			 MULTIPLE DE ESCAPE EXHAUST MS-4102-1E 	 PUNTERIAS VALVE COVER VS-3102-1R 	CARTER OIL PAN OS-1100 
DISTRIBUCIÓN TIMING COVER	 TC-6102-1	RETÉN CIGÜEÑAL CRANK SEAL BS-7100 	SELLOS DE VALVULA STEM SEALS SS-8102-1V 	JUNTAS VARIAS MISCELLANEOUS N/A	N/A

1.6L	MOTOR	MODELOS	DESDE / A	JUNTA DE CABEZA	MULTIPLE DE ADMISIÓN O PLENO
ENGINE	MODELS	FROM / TO	HEAD GASKET	INTAKE	
4L DOHC 16V VIN 6 E-TEC	AVEO, PONTIAC G3 (CABEZA DE MLS).	2008/2012	CA-102-1ML	MS-4102-1A	
<b>FS-102-1ML</b> 			 MULTIPLE DE ESCAPE EXHAUST MS-4102-1E 	 PUNTERIAS VALVE COVER VS-3102-1R 	CARTER OIL PAN OS-1100 
DISTRIBUCIÓN TIMING COVER	 TC-6102-1	RETÉN CIGÜEÑAL CRANK SEAL BS-7100 	SELLOS DE VALVULA STEM SEALS SS-8102-1V 	JUNTAS VARIAS MISCELLANEOUS N/A	N/A













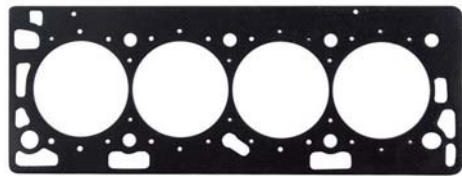

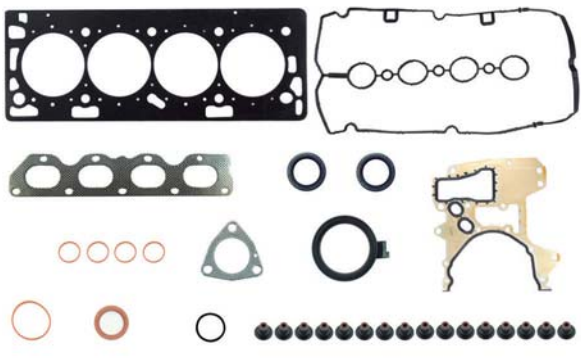

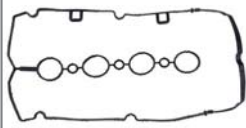



1.8L	MOTOR	MODELOS	DESDE / A	JUNTA DE CABEZA	MULTIPLE DE ADMISIÓN O PLENO
ENGINE	MODELS	FROM / TO	HEAD GASKET	INTAKE	
4L SOHC 8V	CORSA, PICK-UP TORNADO.	2003/2006	CA-118-G 	MS-4100 	
FS-118 			MULTIPLE DE ESCAPE EXHAUST	PUNTERIAS VALVE COVER	CARTER OIL PAN
			MS-4100-E 	VS-3100-1 	OS-1100 
DISTRIBUCIÓN TIMING COVER		RETÉN CIGÜEÑAL CRANK SEAL		SELLOS DE VALVULA STEM SEALS	JUNTAS VARIAS MISCELLANEOUS
TC-6100		BS-7100	SS-8100-V 	N/A	N/A

1.8L	MOTOR	MODELOS	DESDE / A	JUNTA DE CABEZA	MULTIPLE DE ADMISIÓN O PLENO
ENGINE	MODELS	FROM / TO	HEAD GASKET	INTAKE	
4L SOHC 8V	CORSA, PICK-UP TORNADO.	2007/2010	CA-118-G 	MS-4118 	
FS-118-1 			MULTIPLE DE ESCAPE EXHAUST	PUNTERIAS VALVE COVER	CARTER OIL PAN
			MS-4100-E 	VS-3100-1 	OS-1100 
DISTRIBUCIÓN TIMING COVER		RETÉN CIGÜEÑAL CRANK SEAL		SELLOS DE VALVULA STEM SEALS	JUNTAS VARIAS MISCELLANEOUS
TC-6100		BS-7100	SS-8114-V 	N/A	N/A

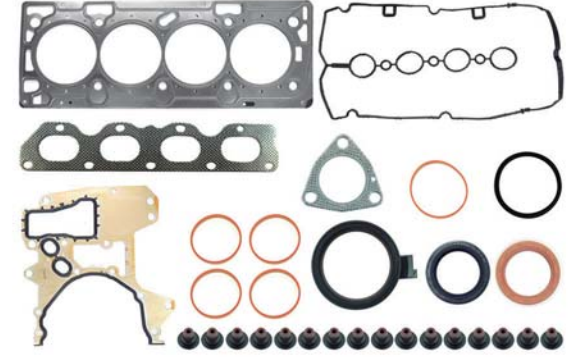

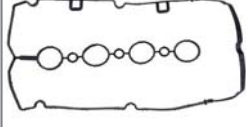









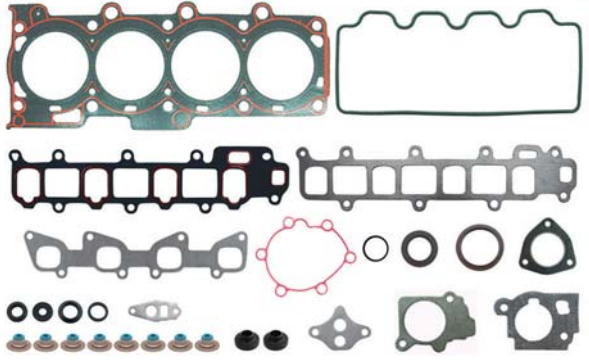







1.8L	MOTOR	MODELOS	DESDE / A	JUNTA DE CABEZA		MULTIPLE DE ADMISIÓN O PLENO
ENGINE	MODELS	FROM / TO	HEAD GASKET		INTAKE	
4L DOHC 16V MOTOR ECOTEC LUW	CRUZE (CABEZA DE GRAFITO).	2011/2013	<b>CA-122-G</b> 		<b>MS-4122</b> 	
<b>FS-122-G</b> 			<b>MULTIPLE DE ESCAPE</b> <b>EXHAUST</b> <b>MS-4122-E</b> 	<b>PUNTERIAS</b> <b>VALVE COVER</b> <b>VS-3122-R</b> 	<b>CARTER</b> <b>OIL PAN</b> N/A	
<b>DISTRIBUCIÓN</b> <b>TIMING COVER</b> <b>TC-6122</b> 	<b>RETÉN CIGÜEÑAL</b> <b>CRANK SEAL</b> <b>BS-7122-NT</b> 	<b>SELLOS DE VALVULA</b> <b>STEM SEALS</b> <b>SS-8122-V</b> 	<b>JUNTAS VARIAS</b> <b>MISCELLANEOUS</b> N/A	N/A		

1.8L	MOTOR	MODELOS	DESDE / A	JUNTA DE CABEZA		MULTIPLE DE ADMISIÓN O PLENO
ENGINE	MODELS	FROM / TO	HEAD GASKET		INTAKE	
4L DOHC 16V MOTOR ECOTEC.	CRUZE, (CABEZA DE MLS).	2011/2013	<b>CA-122-ML</b> 		<b>MS-4122</b> 	
<b>FS-122-ML</b> 			<b>MULTIPLE DE ESCAPE</b> <b>EXHAUST</b> <b>MS-4122-E</b> 	<b>PUNTERIAS</b> <b>VALVE COVER</b> <b>VS-3122-R</b> 	<b>CARTER</b> <b>OIL PAN</b> N/A	
<b>DISTRIBUCIÓN</b> <b>TIMING COVER</b> <b>TC-6122</b> 	<b>RETÉN CIGÜEÑAL</b> <b>CRANK SEAL</b> <b>BS-7122-NT</b> 	<b>SELLOS DE VALVULA</b> <b>STEM SEALS</b> <b>SS-8122-V</b> 	<b>JUNTAS VARIAS</b> <b>MISCELLANEOUS</b> N/A	N/A		

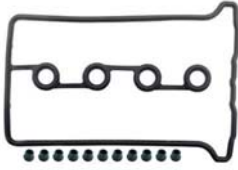

1.9L	MOTOR	MODELOS	DESDE / A	JUNTA DE CABEZA		MÚLTIPLE DE ADMISIÓN O PLENO
ENGINE	MODELS	FROM / TO	HEAD GASKET		INTAKE	
4L SOHC 8V 116" MFI VIN 89	SATURN SL, SL1, SC1, SW1.	1991/1995				
<b>FS-111-G</b> 			<b>MÚLTIPLE DE ESCAPE</b> <b>EXHAUST</b> 		<b>PUNTERIAS</b> <b>VALVE COVER</b> 	<b>CARTER</b> <b>OIL PAN</b> N/A
<b>DISTRIBUCIÓN</b> <b>TIMING COVER</b> 	<b>RETÉN CIGÜEÑAL</b> <b>CRANK SEAL</b> 	<b>SELLOS DE VALVULA</b> <b>STEM SEALS</b> 	<b>JUNTAS VARIAS</b> <b>MISCELLANEOUS</b> N/A			N/A
TC-6115	BS-7115	SS-8111-S				

1.9L	MOTOR	MODELOS	DESDE / A	JUNTA DE CABEZA		MÚLTIPLE DE ADMISIÓN O PLENO
ENGINE	MODELS	FROM / TO	HEAD GASKET		INTAKE	
4L DOHC 16V 116" VIN 7.	SATURN SC, SC2, SL2, SW2.	1991/1995				
<b>FS-115</b> 			<b>MÚLTIPLE DE ESCAPE</b> <b>EXHAUST</b> 		<b>PUNTERIAS</b> <b>VALVE COVER</b> 	<b>CARTER</b> <b>OIL PAN</b> N/A
<b>DISTRIBUCIÓN</b> <b>TIMING COVER</b> 	<b>RETÉN CIGÜEÑAL</b> <b>CRANK SEAL</b> 	<b>SELLOS DE VALVULA</b> <b>STEM SEALS</b> 	<b>JUNTAS VARIAS</b> <b>MISCELLANEOUS</b> N/A			N/A
TC-6115	BS-7115	SS-8115-V				







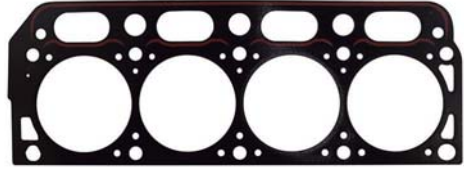

2.0L	MOTOR	MODELOS	DESDE / A	JUNTA DE CABEZA	MULTIPLE DE ADMISIÓN O PLENO
ENGINE	MODELS	FROM / TO	HEAD GASKET	INTAKE	
4L OHV 8V 122"	CAVALIER USA, BERTTA, CORSICA.	1987/1991	CA-108-G 	MS-4108 	
FS-108 			MULTIPLE DE ESCAPE EXHAUST	PUNTERIAS VALVE COVER	CARTER OIL PAN
TC-6108 			MS-4108-E 	VS-3108-R 	OS-1108 
DISTRIBUCIÓN TIMING COVER		RETÉN CIGÜEÑAL CRANK SEAL		SELLOS DE VALVULA STEM SEALS	JUNTAS VARIAS MISCELLANEOUS
TC-6108		BS-7140-R 	SS-8108-V 		

2.2L	MOTOR	MODELOS	DESDE / A	JUNTA DE CABEZA	MULTIPLE DE ADMISIÓN O PLENO
ENGINE	MODELS	FROM / TO	HEAD GASKET	INTAKE	
4L SOHC 8V MOTOR ISUZU	MEXICO PICK-UP LUV PONTIAC BRASIL.	1998/2005	CA-107-G 	MS-4107-1 	
FS-107-1 			MULTIPLE DE ESCAPE EXHAUST	PUNTERIAS VALVE COVER	CARTER OIL PAN
TC-6107-1 			MS-4107-E 	VS-3107 	OS-1107-1 
DISTRIBUCIÓN TIMING COVER		RETÉN CIGÜEÑAL CRANK SEAL		SELLOS DE VALVULA STEM SEALS	JUNTAS VARIAS MISCELLANEOUS
TC-6107-1		BS-7107-1 	SS-8100-V 		N/A

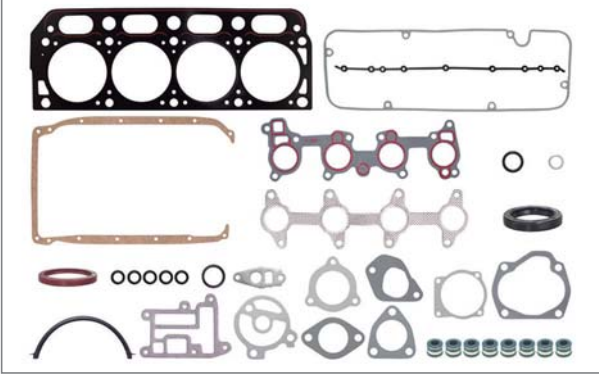
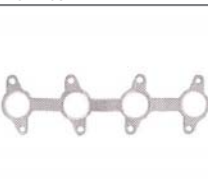
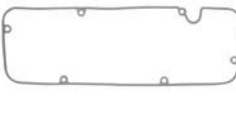
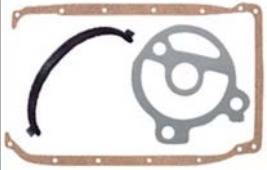

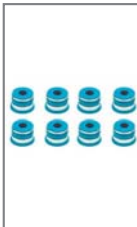
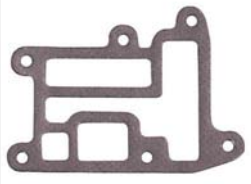

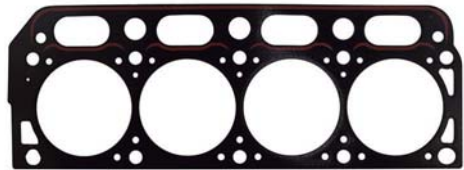
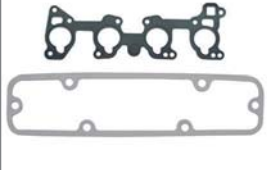
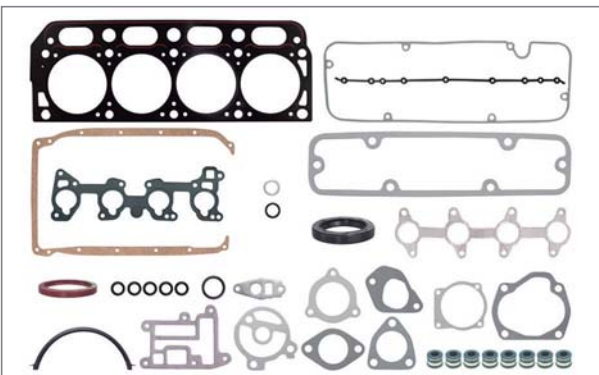
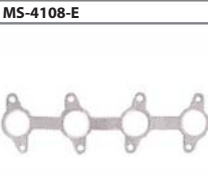
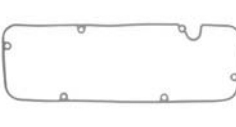
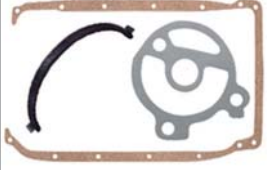
2.2L	MOTOR	MODELOS	DESDE / A	JUNTA DE CABEZA	MULTIPLE DE ADMISIÓN O PLENO
ENGINE	MODELS	FROM / TO	HEAD GASKET	INTAKE	
4L OHV 8V 134"	CAVALIER USA, BERTETTA, CORSICA.	1990/1991	<b>CA-108-G</b> 	<b>MS-4108</b> 	
<b>FS-108</b> 			<b>MULTIPLE DE ESCAPE</b> <b>EXHAUST</b> <b>MS-4108-E</b> 	<b>PUNTERIAS</b> <b>VALVE COVER</b> <b>VS-3108-R</b> 	<b>CARTER</b> <b>OIL PAN</b> <b>OS-1108</b> 
<b>DISTRIBUCIÓN</b> <b>TIMING COVER</b> <b>TC-6108</b> 	<b>RETÉN CIGÜEÑAL</b> <b>CRANK SEAL</b> <b>BS-7140-R</b> 	<b>SELLOS DE VALVULA</b> <b>STEM SEALS</b> <b>SS-8108-V</b> 	<b>JUNTAS VARIAS</b> <b>MISCELLANEOUS</b> 		

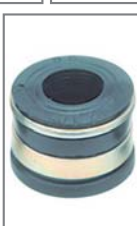
2.2L	MOTOR	MODELOS	DESDE / A	JUNTA DE CABEZA	MULTIPLE DE ADMISIÓN O PLENO
ENGINE	MODELS	FROM / TO	HEAD GASKET	INTAKE	
4L OHV 8V 134"	CAVALIER AMERICANO, CUTTLAS, CENTURY.	1992/1993	<b>CA-108-G</b> 	<b>MS-4108-1</b> 	
<b>FS-108-1</b> 			<b>MULTIPLE DE ESCAPE</b> <b>EXHAUST</b> <b>MS-4108-E</b> 	<b>PUNTERIAS</b> <b>VALVE COVER</b> <b>VS-3108-R</b> 	<b>CARTER</b> <b>OIL PAN</b> <b>OS-1108</b> 
<b>DISTRIBUCIÓN</b> <b>TIMING COVER</b> <b>TC-6108</b> 	<b>RETÉN CIGÜEÑAL</b> <b>CRANK SEAL</b> <b>BS-7140-R</b> 	<b>SELLOS DE VALVULA</b> <b>STEM SEALS</b> <b>SS-8140-12P</b> 	<b>JUNTAS VARIAS</b> <b>MISCELLANEOUS</b> <b>N/A</b>		





2.2L	MOTOR	MODELOS	DESDE / A	JUNTA DE CABEZA	MULTIPLE DE ADMISIÓN O PLENO
ENGINE	MODELS	FROM / TO	HEAD GASKET	INTAKE	
4L OHV 8V 134"	CAVALIER, BUICK CENTURY, PONTIAC SUNFIRE SE.	1994/1997	CA-108-G 	MS-4108-1 	
FS-108-2 			MULTIPLE DE ESCAPE EXHAUST	PUNTERIAS VALVE COVER	CARTER OIL PAN
			MS-4108-E 	VS-3108-R 	OS-1108 
DISTRIBUCIÓN TIMING COVER		RETÉN CIGÜEÑAL CRANK SEAL		SELLOS DE VALVULA STEM SEALS	JUNTAS VARIAS MISCELLANEOUS
TC-6108		BS-7140-R	SS-8108-V 	N/A	N/A

2.2L	MOTOR	MODELOS	DESDE / A	JUNTA DE CABEZA	MULTIPLE DE ADMISIÓN O PLENO
ENGINE	MODELS	FROM / TO	HEAD GASKET	INTAKE	
4L OHV 8V 134"	PICK UP S-10, SONOMA, ISUZU HOMBRE.	1994/1997	CA-112-G 	MS-4108-1 	
FS-112 			MULTIPLE DE ESCAPE EXHAUST	PUNTERIAS VALVE COVER	CARTER OIL PAN
			MS-4108-E 	VS-3108-R 	OS-1108 
DISTRIBUCIÓN TIMING COVER		RETÉN CIGÜEÑAL CRANK SEAL		SELLOS DE VALVULA STEM SEALS	JUNTAS VARIAS MISCELLANEOUS
TC-6108		BS-7140-R	SS-8108-V 		



2.2L	MOTOR	MODELOS	DESDE / A	JUNTA DE CABEZA	MULTIPLE DE ADMISIÓN O PLENO
ENGINE	MODELS	FROM / TO	HEAD GASKET	INTAKE	
4L OHV 8V 134" VIN 4	CAVALIER, S-10, SONOMA.	1998/2002	CA-112-G 	MS-4112 	
FS-112-1 			MULTIPLE DE ESCAPE EXHAUST	PUNTERIAS VALVE COVER	CARTER OIL PAN
			MS-4112-E 	VS-3112-R 	OS-1108 
DISTRIBUCIÓN TIMING COVER		RETÉN CIGÜEÑAL CRANK SEAL	SELLOS DE VALVULA STEM SEALS	JUNTAS VARIAS MISCELLANEOUS	N/A
TC-6108 		BS-7140-R 	SS-8112-V 	N/A	

2.3L	MOTOR	MODELOS	DESDE / A	JUNTA DE CABEZA	MULTIPLE DE ADMISIÓN O PLENO
ENGINE	MODELS	FROM / TO	HEAD GASKET	INTAKE	
4L DOHC 16V QUAD4 VIN A, D.	BERETTA, PONTIAC GRAND AM, GRAND PRIX, CLUTLASS, SKYLARK.	1987/1991	CA-109-G 	MS-4109 	
FS-109 			MULTIPLE DE ESCAPE EXHAUST	PUNTERIAS VALVE COVER	CARTER OIL PAN
			MS-4109-1E 	VS-3109-1R 	OS-1109 
DISTRIBUCIÓN TIMING COVER		RETÉN CIGÜEÑAL CRANK SEAL	SELLOS DE VALVULA STEM SEALS	JUNTAS VARIAS MISCELLANEOUS	N/A
TC-6109-3 		BS-7109 	SS-8109-1V 	N/A	









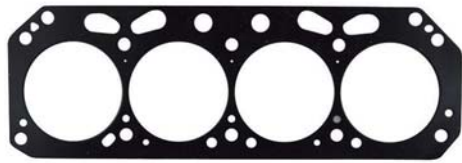

2.4L	MOTOR	MODELOS	DESDE / A	JUNTA DE CABEZA	MÚLTIPLE DE ADMISIÓN O PLENO
ENGINE	MODELS	FROM / TO	HEAD GASKET	INTAKE	
4L DOHC 16V VIN T.	PONTIAC SUNFIRE, GRAND AM, CAVALIER, MALIBU.	1997/2002	CA-109-1G 	MS-4109-1NS 	
FS-109-1 			MÚLTIPLE DE ESCAPE EXHAUST MS-4109-E 	PUNTERIAS VALVE COVER VS-3109-2R 	CARTER OIL PAN OS-1109-1 
DISTRIBUCIÓN TIMING COVER TC-6109 	RETÉN CIGÜEÑAL CRANK SEAL BS-7109 	SELLOS DE VALVULA STEM SEALS SS-8109-1V 	JUNTAS VARIAS MISCELLANEOUS N/A	N/A	

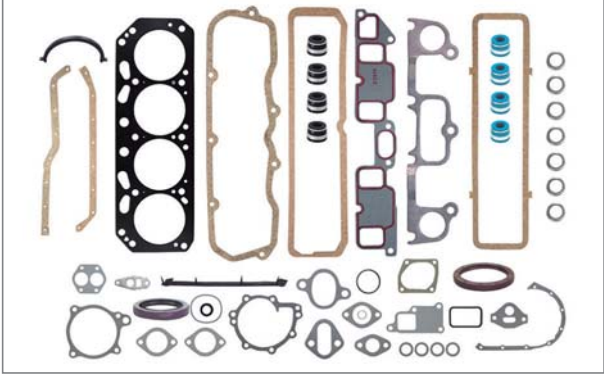
2.5L	MOTOR	MODELOS	DESDE / A	JUNTA DE CABEZA	MÚLTIPLE DE ADMISIÓN O PLENO
ENGINE	MODELS	FROM / TO	HEAD GASKET	INTAKE	
4L OHV 8V 151" VIN E	S10, ASTRO, CELEBRITY, S15, SAFARI, CUTLASS.	1988/1990	CA-105-G 	MS-4105-1 	
FS-105-2 			MÚLTIPLE DE ESCAPE EXHAUST MS-4105-1E 	PUNTERIAS VALVE COVER VS-3105-2 	CARTER OIL PAN OS-1105 
DISTRIBUCIÓN TIMING COVER TC-6130 	RETÉN CIGÜEÑAL CRANK SEAL BS-7105 	SELLOS DE VALVULA STEM SEALS SS-8105-V 	JUNTAS VARIAS MISCELLANEOUS N/A	N/A	



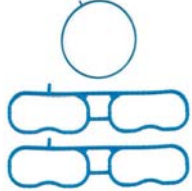
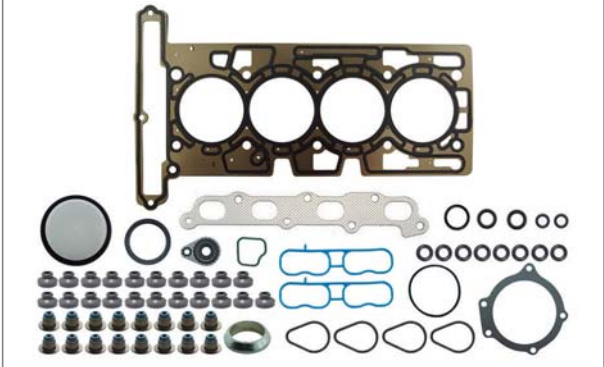

2.5L	MOTOR	MODELOS	DESDE / A	JUNTA DE CABEZA		MÚLTIPLE DE ADMISIÓN O PLENO	
ENGINE	MODELS	FROM / TO	HEAD GASKET		INTAKE		
4L OHV 8V 151" VIN A R	CELEBRITY, CENTURY, CUTLASS, SONOMA, S10, LUMINA.	1990/1993	<b>CA-105-G</b> 		<b>MS-4105-3</b> 		
<b>FS-105-3</b>							
<b>DISTRIBUCIÓN</b>		<b>RETÉN CIGÜEÑAL</b>		<b>SELLOS DE VALVULA</b>		<b>JUNTAS VARIAS</b>	
<b>TIMING COVER</b>		<b>CRANK SEAL</b>		<b>STEM SEALS</b>		<b>MISCELLANEOUS</b>	
TC-6130		BS-7105		SS-8105-V		N/A	
							

2.8L	MOTOR	MODELOS	DESDE / A	JUNTA DE CABEZA		MÚLTIPLE DE ADMISIÓN O PLENO	
ENGINE	MODELS	FROM / TO	HEAD GASKET		INTAKE		
4L DOHC 169" 16V VIN 8 MOTOR LK5 16V VIN 8	COLORADO, CANYON.	2004/2006	<b>CA-126-ML</b> 		<b>MS-4126</b> 		
<b>FS-126-ML</b>							
<b>DISTRIBUCIÓN</b>		<b>RETÉN CIGÜEÑAL</b>		<b>SELLOS DE VALVULA</b>		<b>JUNTAS VARIAS</b>	
<b>TIMING COVER</b>		<b>CRANK SEAL</b>		<b>STEM SEALS</b>		<b>MISCELLANEOUS</b>	
TC-6153-1		BS-7126-T					
							





2.8L	MOTOR	MODELOS	DESDE / A	JUNTA DE CABEZA		MÚLTIPLE DE ADMISIÓN O PLENO
ENGINE	MODELS	FROM / TO	HEAD GASKET		INTAKE	
V6 OHV 12V 173" VIN B X Z 1 7	CELEBRITY, CITATION, S10, PONTIAC FIREBIRD.	1980/1984	CA-140-G		MS-4140-A	
DISTRIBUCIÓN		RETÉN CIGÜEÑAL	SELLOS DE VALVULA		JUNTAS VARIAS	
TIMING COVER		CRANK SEAL	STEM SEALS		MISCELLANEOUS	
TC-6140		BS-7140-1R				
			MS-4140-E		VS-3140	OS-1140-1C

2.8L	MOTOR	MODELOS	DESDE / A	JUNTA DE CABEZA		MÚLTIPLE DE ADMISIÓN O PLENO
ENGINE	MODELS	FROM / TO	HEAD GASKET		INTAKE	
V6 OHV 12V 173" VIN W	CUTLASS, CAVALIER, CELEBRITY, CITATION, COMANCHE, WAGONEER.	1985/1986	CA-140-G		MS-4140-A	
DISTRIBUCIÓN		RETÉN CIGÜEÑAL	SELLOS DE VALVULA		JUNTAS VARIAS	
TIMING COVER		CRANK SEAL	STEM SEALS		MISCELLANEOUS	
TC-6140		BS-7140-R				
			MS-4140-E		VS-3140-1	OS-1140-1C



2.8L	MOTOR	MODELOS	DESDE / A	JUNTA DE CABEZA		MÚLTIPLE DE ADMISIÓN O PLENO
ENGINE	MODELS	FROM / TO	HEAD GASKET		INTAKE	
V6 OHV 12V 173" VIN R	CAMIONETA S-10, SONOMA, CELEBRITY.	1987/1993	CA-140-G		MS-4140-A	
DISTRIBUCIÓN		RETÉN CIGÜEÑAL	SELLOS DE VALVULA		JUNTAS VARIAS	
TIMING COVER		CRANK SEAL	STEM SEALS		MISCELLANEOUS	
TC-6140-1		BS-7140-R				

2.8L	MOTOR	MODELOS	DESDE / A	JUNTA DE CABEZA		MÚLTIPLE DE ADMISIÓN O PLENO
ENGINE	MODELS	FROM / TO	HEAD GASKET		INTAKE	
V6 OHV 12V	MPFI 2a GENERACION, CAVALIER, CUTLASS, EUROSPORT, CENTURY.	1988/1994	CA-141-G		MS-4141-A	
DISTRIBUCIÓN		RETÉN CIGÜEÑAL	SELLOS DE VALVULA		JUNTAS VARIAS	
TIMING COVER		CRANK SEAL	STEM SEALS		MISCELLANEOUS	
TC-6140-1		BS-7140-R				



3.1L	MOTOR	MODELOS	DESDE / A	JUNTA DE CABEZA	MULTIPLE DE ADMISIÓN O PLENO
ENGINE	MODELS	FROM / TO	HEAD GASKET	INTAKE	
V6 OHV 12V VIN T	CAVALIER, CUT-LASS, CENTURY.	1988/1995	CA-141-G 	MS-4141-A 	
FS-141 			MULTIPLE DE ESCAPE EXHAUST	PUNTERIAS VALVE COVER	CARTER OIL PAN
			MS-4141-E 	VS-3141-R 	OS-1140-1R 
DISTRIBUCIÓN TIMING COVER		RETÉN CIGÜEÑAL CRANK SEAL		SELLOS DE VALVULA STEM SEALS	
TC-6140-1		BS-7140-R		SS-8141-V	JUNTAS VARIAS MISCELLANEOUS
					N/A

3.1L	MOTOR	MODELOS	DESDE / A	JUNTA DE CABEZA	MULTIPLE DE ADMISIÓN O PLENO
ENGINE	MODELS	FROM / TO	HEAD GASKET	INTAKE	
V6 OHV 12V 189" VIN J	LUMINA SEDAN, MALIBU.	2000/2003	CA-145-G 	MS-4145-2 	
FS-145-1 			MULTIPLE DE ESCAPE EXHAUST	PUNTERIAS VALVE COVER	CARTER OIL PAN
			MS-4145-E 	VS-3145-R 	OS-1145-R 
DISTRIBUCIÓN TIMING COVER		RETÉN CIGÜEÑAL CRANK SEAL		SELLOS DE VALVULA STEM SEALS	
TC-6140-1		BS-7140-R		SS-8145-V	JUNTAS VARIAS MISCELLANEOUS
					N/A













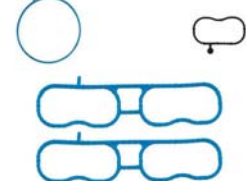
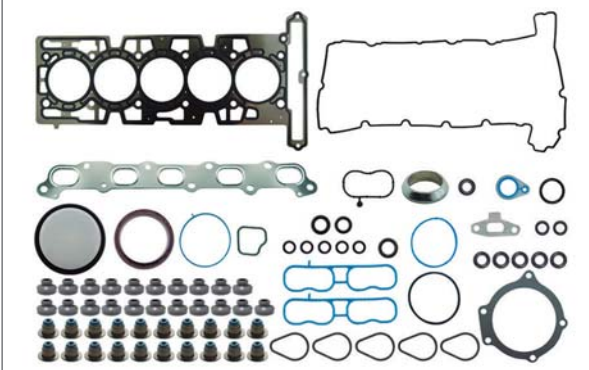

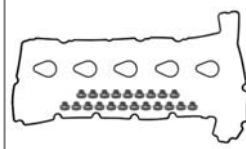
3.1L	MOTOR	MODELOS	DESDE / A	JUNTA DE CABEZA	MULTIPLE DE ADMISIÓN O PLENO
ENGINE	MODELS	FROM / TO	HEAD GASKET	INTAKE	
V6 OHV 12V 189" VIN M	CENTURY, LUMINA, MALIBU, GRAND PRIX.	1995/1999	CA-145-G 	MS-4145-2 	
FS-145-2 			MULTIPLE DE ESCAPE EXHAUST	PUNTERIAS VALVE COVER	CARTER OIL PAN
TC-6140-1 			RETÉN CIGÜEÑAL CRANK SEAL	SELLOS DE VALVULA STEM SEALS	JUNTAS VARIAS MISCELLANEOUS
BS-7140-R 			SS-8145-V 	N/A	N/A

3.4L	MOTOR	MODELOS	DESDE / A	JUNTA DE CABEZA	MULTIPLE DE ADMISIÓN O PLENO
ENGINE	MODELS	FROM / TO	HEAD GASKET	INTAKE	
V6 OHV 12V VIN E.	VENTURE, IMPALA, MONTE CARLO, TRANS SPORT, AZ-TEK, GRAND AM.	1996/2003	CA-173-G 	MS-4145-2 	
FS-173-1 			MULTIPLE DE ESCAPE EXHAUST	PUNTERIAS VALVE COVER	CARTER OIL PAN
TC-6140-1 			RETÉN CIGÜEÑAL CRANK SEAL	SELLOS DE VALVULA STEM SEALS	JUNTAS VARIAS MISCELLANEOUS
BS-7140-R 			SS-8145-V 		

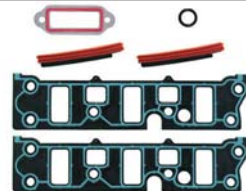
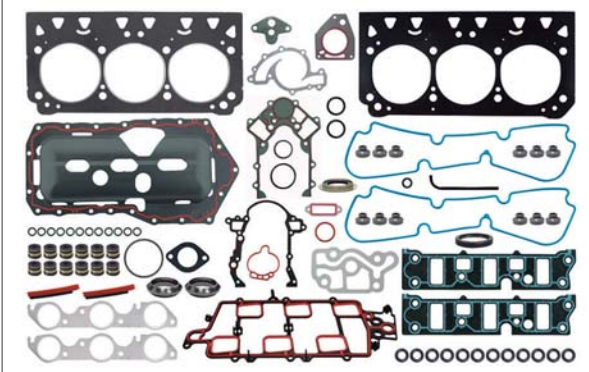

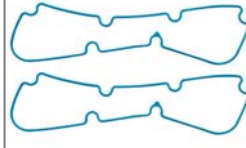

3.5L	MOTOR	MODELOS	DESDE / A	JUNTA DE CABEZA	MULTIPLE DE ADMISIÓN O PLENO	
ENGINE	MODELS	FROM / TO	HEAD GASKET	INTAKE		
5L DOHC 20 V 211" VIN 6	COLORADO, CANYON, H3, i-350.	2004/2006	CA-128-ML 	MS-4128 		
FS-128-ML 				MULTIPLE DE ESCAPE EXHAUST MS-4154-E 	PUNTERIAS VALVE COVER VS-3154-R 	CARTER OIL PAN
DISTRIBUCIÓN TIMING COVER		RETÉN CIGÜEÑAL CRANK SEAL BS-7126-1 	SELLOS DE VALVULA STEM SEALS	JUNTAS VARIAS MISCELLANEOUS		

3.8L	MOTOR	MODELOS	DESDE / A	JUNTA DE CABEZA	MULTIPLE DE ADMISIÓN O PLENO	
ENGINE	MODELS	FROM / TO	HEAD GASKET	INTAKE		
V6 OHV 12V 231" VIN K	GRAND PRIX, MONTE CARLO, LUMINA, IMPALA, BONNEVILLE.	1997/2005	CA-148-G y CA-149-G <p>PARA VER IMAGEN DIRIGIRSE A SECCIÓN DE JUNTAS DE CABEZA. TO SEE IMAGE GO TO HEAD GASKET SECTION</p>	MS-4148-NS1 		
FS-148 				MULTIPLE DE ESCAPE EXHAUST MS-4148-E 	PUNTERIAS VALVE COVER VS-3148-R 	CARTER OIL PAN OS-1148-R 
DISTRIBUCIÓN TIMING COVER TC-6148 		RETÉN CIGÜEÑAL CRANK SEAL BS-7148 	SELLOS DE VALVULA STEM SEALS SS-8141-V 	JUNTAS VARIAS MISCELLANEOUS N/A	N/A	



4.1L	MOTOR	MODELOS	DESDE / A	JUNTA DE CABEZA	MULTIPLE DE ADMISIÓN O PLENO
ENGINE	MODELS	FROM / TO	HEAD GASKET	INTAKE	
6L OHV 12V	AUTOS Y CAMIONES CARBURADOS & TBI.	1963/1992	CA-130-G 	MS-4130-1 	
FS-130 					
			MULTIPLE DE ESCAPE EXHAUST ** N/A ** N/A	PUNTERIAS VALVE COVER VS-3130 	CARTER OIL PAN OS-1130 
DISTRIBUCIÓN TIMING COVER TC-6130 	RETÉN CIGÜEÑAL CRANK SEAL BS-7130-2 		SELLOS DE VALVULA STEM SEALS SS-8110 	JUNTAS VARIAS MISCELLANEOUS 	

4.2L	MOTOR	MODELOS	DESDE / A	JUNTA DE CABEZA	MULTIPLE DE ADMISIÓN O PLENO
ENGINE	MODELS	FROM / TO	HEAD GASKET	INTAKE	
6L DOHC 24V 256" MOTOR VORTEC VIN S	TRAILBLAZER, ENVOY, ASCENDER, BRAVADA (CABEZA DE GRAFITO).	2002/2006	CA-153-G 	MS-4153 	
FS-153 					
			MULTIPLE DE ESCAPE EXHAUST MS-4153-E 	PUNTERIAS VALVE COVER VS-3153-R 	CARTER OIL PAN  N/A
DISTRIBUCIÓN TIMING COVER TC-6153 	RETÉN CIGÜEÑAL CRANK SEAL BS-7153-NT 		SELLOS DE VALVULA STEM SEALS SS-8153-V 	JUNTAS VARIAS MISCELLANEOUS N/A	



4.3L	MOTOR	MODELOS	DESDE / A	JUNTA DE CABEZA	MULTIPLE DE ADMISIÓN O PLENO
ENGINE	MODELS	FROM / TO	HEAD GASKET	INTAKE	
V6 OHV 12V VIN Z	ASTRO, PICKUP C10, C20, C1500, C2500, SAFARI, CAPRICE, EL CAMINO.	1985/1990	CA-144-G 	MS-4144 	
FS-144 			MULTIPLE DE ESCAPE EXHAUST	PUNTERIAS VALVE COVER	CARTER OIL PAN
			MS-4144-E 	VS-3144 	OS-1143 
DISTRIBUCIÓN TIMING COVER		RETÉN CIGÜEÑAL CRANK SEAL		SELLOS DE VALVULA STEM SEALS	JUNTAS VARIAS MISCELLANEOUS
TC-6150-5		BS-7130-2		SS-8140-12P 	

4.3L	MOTOR	MODELOS	DESDE / A	JUNTA DE CABEZA	MULTIPLE DE ADMISIÓN O PLENO
ENGINE	MODELS	FROM / TO	HEAD GASKET	INTAKE	
V6 OHV 12V TBI VIN W Z	ASTRO, PICK UP S10, S15, C1500, C2500, G10, G20, G30, JIMMY, SAFARI (MOTOR TBI).	1986/1992	CA-144-G 	MS-4144-1 	
FS-144-1 			MULTIPLE DE ESCAPE EXHAUST	PUNTERIAS VALVE COVER	CARTER OIL PAN
			MS-4144-E 	VS-3144 	OS-1144-R 
DISTRIBUCIÓN TIMING COVER		RETÉN CIGÜEÑAL CRANK SEAL		SELLOS DE VALVULA STEM SEALS	JUNTAS VARIAS MISCELLANEOUS
TC-6150-5		BS-7160		SS-8140-12P 	N/A





4.3L	MOTOR	MODELOS	DESDE / A	JUNTA DE CABEZA		MÚLTIPLE DE ADMISIÓN O PLENO
ENGINE	MODELS	FROM / TO	HEAD GASKET		INTAKE	
V6 OHV 12V VIN VIN B W Z	ASTRO, SAFARI.	1986/1992	CA-144-G		MS-4144-1	
FS-144-2						
			MÚLTIPLE DE ESCAPE	PUNTERIAS	CARTER	
			EXHAUST	VALVE COVER	OIL PAN	
			MS-4144-E	VS-3144-R	OS-1144-R	
DISTRIBUCIÓN		RETÉN CIGÜEÑAL		SELLOS DE VALVULA		JUNTAS VARIAS
TIMING COVER		CRANK SEAL		STEM SEALS		MISCELLANEOUS
TC-6150-5		BS-7160		SS-8140-12P		N/A

4.3L	MOTOR	MODELOS	DESDE / A	JUNTA DE CABEZA		MÚLTIPLE DE ADMISIÓN O PLENO
ENGINE	MODELS	FROM / TO	HEAD GASKET		INTAKE	
V6 OHV 12V VIN W Z	SONOMA, S-10, S-15, ASTRO, SAFARI, C1500, C2500, K1500, K2500.	1993	CA-144-G		MS-4144-2	
FS-144-3						
			MÚLTIPLE DE ESCAPE	PUNTERIAS	CARTER	
			EXHAUST	VALVE COVER	OIL PAN	
			MS-4144-E	VS-3144	OS-1144-R	
DISTRIBUCIÓN		RETÉN CIGÜEÑAL		SELLOS DE VALVULA		JUNTAS VARIAS
TIMING COVER		CRANK SEAL		STEM SEALS		MISCELLANEOUS
TC-6150-5		BS-7160		SS-8140-12P		N/A





4.3L	MOTOR	MODELOS	DESDE / A	JUNTA DE CABEZA	MULTIPLE DE ADMISIÓN O PLENO
ENGINE	MODELS	FROM / TO	HEAD GASKET	INTAKE	
V6 OHV 12V VIN W Z	ASTRO, SAFARI, SONOMA, C1500, C2500, G1500, G2500, G3500, JIMMY.	1994/1995	CA-144-G 	MS-4144-2 	
FS-144-4 			MULTIPLE DE ESCAPE EXHAUST MS-4144-E 	PUNTERIAS VALVE COVER VS-3144-1R 	CARTER OIL PAN OS-1144-R 
DISTRIBUCIÓN TIMING COVER TC-6150-5 	RETÉN CIGÜEÑAL CRANK SEAL BS-7160 	SELLOS DE VALVULA STEM SEALS SS-8140-12P 	JUNTAS VARIAS MISCELLANEOUS N/A	N/A	

4.3L	MOTOR	MODELOS	DESDE / A	JUNTA DE CABEZA	MULTIPLE DE ADMISIÓN O PLENO
ENGINE	MODELS	FROM / TO	HEAD GASKET	INTAKE	
V6 OHV 12V VIN W VOR-TEC	ASTRO, S10, BLAZER, SAFARI, SONOMA, S-15, JIMMY.	1992/1993	CA-144-G 	MS-4144-3 	
FS-144-5 			MULTIPLE DE ESCAPE EXHAUST MS-4144-E 	PUNTERIAS VALVE COVER VS-3144 	CARTER OIL PAN OS-1144-R 
DISTRIBUCIÓN TIMING COVER TC-6144 	RETÉN CIGÜEÑAL CRANK SEAL BS-7160 	SELLOS DE VALVULA STEM SEALS SS-8140-12P 	JUNTAS VARIAS MISCELLANEOUS N/A	N/A	



4.3L	MOTOR	MODELOS	DESDE / A	JUNTA DE CABEZA	MULTIPLE DE ADMISIÓN O PLENO
ENGINE	MODELS	FROM / TO	HEAD GASKET	INTAKE	
V6 OHV 12V VIN W Z VORTEC	ASTRO, SAFARI, S-10, BLAZER, JIMMY.	1994/1995	CA-144-G 	MS-4144-3 	
FS-144-6 			MULTIPLE DE ESCAPE EXHAUST	PUNTERIAS VALVE COVER	CARTER OIL PAN
			MS-4144-E 	VS-3144-1R 	OS-1144-R 
DISTRIBUCIÓN TIMING COVER	RETÉN CIGÜEÑAL CRANK SEAL		SELLOS DE VALVULA STEM SEALS	JUNTAS VARIAS MISCELLANEOUS	N/A
TC-6144 	BS-7160 		SS-8140-12P 	N/A	

4.3L	MOTOR	MODELOS	DESDE / A	JUNTA DE CABEZA	MULTIPLE DE ADMISIÓN O PLENO
ENGINE	MODELS	FROM / TO	HEAD GASKET	INTAKE	
V6 OHV 12V VIN W X MOTOR VORTEC	SAFARI, ASTRO, SONOMA, S-10, JIMMY, SAVANA 1500, SIERRA 1500, SILVERADO 1500, SONORA, EXPRESS VAN, C1500.	1996/2011	CA-144-G 	MS-4144-4 	
FS-144-7 			MULTIPLE DE ESCAPE EXHAUST	PUNTERIAS VALVE COVER	CARTER OIL PAN
			MS-4144-1E 	VS-3144-1R 	OS-1144-1R 
DISTRIBUCIÓN TIMING COVER	RETÉN CIGÜEÑAL CRANK SEAL		SELLOS DE VALVULA STEM SEALS	JUNTAS VARIAS MISCELLANEOUS	N/A
TC-6150-5 	BS-7160 		SS-8160-12V 	N/A	



4.3L	MOTOR	MODELOS	DESDE / A	JUNTA DE CABEZA	MULTIPLE DE ADMISIÓN O PLENO
ENGINE	MODELS	FROM / TO	HEAD GASKET	INTAKE	
V8 V8 OHV 16V 265" MOTOR VORTEC	CAPRICE.	1994/1996	CA-151-G 	MS-4151 	
<b>FS-151</b> 			MULTIPLE DE ESCAPE EXHAUST MS-4151-E 	PUNTERIAS VALVE COVER VS-3150-1R 	CARTER OIL PAN OS-1150-1R 
DISTRIBUCIÓN TIMING COVER TC-6150-6 	RETÉN CIGÜEÑAL CRANK SEAL BS-7160 	SELLOS DE VALVULA STEM SEALS SS-8160-16V 	JUNTAS VARIAS MISCELLANEOUS N/A	N/A	

4.8L	MOTOR	MODELOS	DESDE / A	JUNTA DE CABEZA	MULTIPLE DE ADMISIÓN O PLENO
ENGINE	MODELS	FROM / TO	HEAD GASKET	INTAKE	
6L OHV 12V	AUTOS Y CAMIONES CARBURADOS & TBI.	1963/1992	CA-130-G 	MS-4130-1 	
<b>FS-130</b> 			MULTIPLE DE ESCAPE EXHAUST N/A	PUNTERIAS VALVE COVER VS-3130 	CARTER OIL PAN OS-1130 
DISTRIBUCIÓN TIMING COVER TC-6130 	RETÉN CIGÜEÑAL CRANK SEAL BS-7130-2 	SELLOS DE VALVULA STEM SEALS SS-8110 	JUNTAS VARIAS MISCELLANEOUS		





4.8L	MOTOR	MODELOS	DESDE / A	JUNTA DE CABEZA	MULTIPLE DE ADMISIÓN O PLENO
ENGINE	MODELS	FROM / TO	HEAD GASKET	INTAKE	
V8 OHV 16V VORTEC VIN VT	CHEYENNE, SILVERADO 1500, 2500, SUBURBAN, YUKON, SIERRA 1500, 2500, TAHOE (CABEZAS DE GRAFITO).	1999/2001	<b>CA-175-G</b> 	<b>MS-4175-NS</b> 	
<b>FS-175-G</b> 			<b>MULTIPLE DE ESCAPE</b> <b>EXHAUST</b> <b>MS-4175-E</b> 	<b>PUNTERIAS</b> <b>VALVE COVER</b> <b>VS-3175-R</b> 	<b>CARTER</b> <b>OIL PAN</b> <b>OS-1175</b> 
<b>DISTRIBUCIÓN</b> <b>TIMING COVER</b> <b>TC-6175</b> 	<b>RETÉN CIGÜEÑAL</b> <b>CRANK SEAL</b> <b>BS-7175-NT</b> 	<b>SELLOS DE VALVULA</b> <b>STEM SEALS</b> <b>SS-8152-V</b> 	<b>JUNTAS VARIAS</b> <b>MISCELLANEOUS</b> <b>N/A</b>		





4.8L	MOTOR	MODELOS	DESDE / A	JUNTA DE CABEZA	MULTIPLE DE ADMISIÓN O PLENO
ENGINE	MODELS	FROM / TO	HEAD GASKET	INTAKE	
V8 OHV 16V VIN TV	CHEYENNE, SILVERADO 1500, 2500, SUBURBAN, YUKON, SIERRA 1500, 2500, TAHOE (CABEZAS DE MLS).	1999/2001	<b>CA-175-ML</b> 	<b>MS-4175-NS</b> 	
<b>FS-175-ML</b> 			<b>MULTIPLE DE ESCAPE</b> <b>EXHAUST</b> <b>MS-4175-E</b> 	<b>PUNTERIAS</b> <b>VALVE COVER</b> <b>VS-3175-R</b> 	<b>CARTER</b> <b>OIL PAN</b> <b>OS-1175-1R</b> 
<b>DISTRIBUCIÓN</b> <b>TIMING COVER</b> <b>TC-6175-LS</b> 	<b>RETÉN CIGÜEÑAL</b> <b>CRANK SEAL</b> <b>BS-7175-NT</b> 	<b>SELLOS DE VALVULA</b> <b>STEM SEALS</b> <b>SS-8152-V</b> 	<b>JUNTAS VARIAS</b> <b>MISCELLANEOUS</b> <b>N/A</b>		





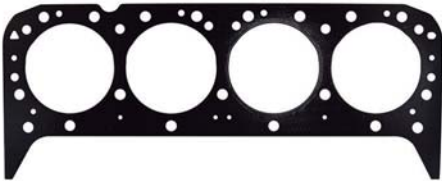

4.8L	MOTOR	MODELOS	DESDE / A	JUNTA DE CABEZA	MULTIPLE DE ADMISIÓN O PLENO
ENGINE	MODELS	FROM / TO	HEAD GASKET	INTAKE	
V8 OHV 16V VORTEC VIN T Z V	SUBURBAN, SILVERADO 1500, 2500, SIERRA 1500, 2500, YUKON, AVALANCHE, SAVANA, EXPRESS VAN 1500, 2500, SONORA.	2002/2009	<b>CA-175-G</b> 	<b>MS-4175-1NS</b> 	
<b>FS-175-1G</b>			<b>MULTIPLE DE ESCAPE</b> <b>EXHAUST</b> <b>MS-4175-E</b> 	<b>PUNTERIAS</b> <b>VALVE COVER</b> <b>VS-3175-R</b> 	<b>CARTER</b> <b>OIL PAN</b> <b>OS-1175</b> 
<b>DISTRIBUCIÓN</b> <b>TIMING COVER</b>		<b>RETÉN CIGÜEÑAL</b> <b>CRANK SEAL</b>		<b>SELLOS DE VALVULA</b> <b>STEM SEALS</b>	<b>JUNTAS VARIAS</b> <b>MISCELLANEOUS</b>
TC-6175		BS-7175-NT	SS-8152-1V	N/A	N/A

5.0L	MOTOR	MODELOS	DESDE / A	JUNTA DE CABEZA	MULTIPLE DE ADMISIÓN O PLENO
ENGINE	MODELS	FROM / TO	HEAD GASKET	INTAKE	
V8 OHV 16V 305" VORTEC VIN M	EXPRESS VAN 1500, 2500, C1500, C2500, K1500, K500, SAVANA.	1996/2002	<b>CA-160-G</b> 	<b>MS-4150-9</b> 	
<b>FS-160-2</b>			<b>MULTIPLE DE ESCAPE</b> <b>EXHAUST</b> <b>MS-4150-2E</b> 	<b>PUNTERIAS</b> <b>VALVE COVER</b> <b>VS-3150-1R</b> 	<b>CARTER</b> <b>OIL PAN</b> <b>OS-1150-1R</b> 
<b>DISTRIBUCIÓN</b> <b>TIMING COVER</b>		<b>RETÉN CIGÜEÑAL</b> <b>CRANK SEAL</b>		<b>SELLOS DE VALVULA</b> <b>STEM SEALS</b>	<b>JUNTAS VARIAS</b> <b>MISCELLANEOUS</b>
TC-6150-5		BS-7160-1T	SS-8160-16V		N/A

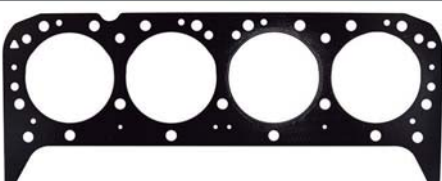
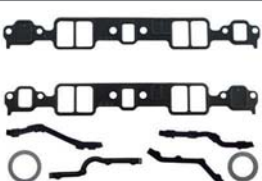

5.0L	MOTOR	MODELOS	DESDE / A	JUNTA DE CABEZA	MULTIPLE DE ADMISIÓN O PLENO
ENGINE	MODELS	FROM / TO	HEAD GASKET	INTAKE	
V8 OHV 16V 305" VIN H, E, Y, 9	CAPRICE, MONTE CARLO, C1500, C2500, CAMARO, PONTIAC GRAND PRIX, FIREBIRD, MOTOR TBI.	1987/1995	<b>CA-160-G</b> 	<b>MS-4150-6</b> 	
<b>FS-160-5</b>			<b>MULTIPLE DE ESCAPE</b> <b>EXHAUST</b> <b>MS-4150-E</b> 	<b>PUNTERIAS</b> <b>VALVE COVER</b> <b>VS-3150-1R</b> 	<b>CARTER</b> <b>OIL PAN</b> <b>OS-1150-1R</b> 
<b>DISTRIBUCIÓN</b> <b>TIMING COVER</b>	<b>RETÉN CIGÜEÑAL</b> <b>CRANK SEAL</b>	<b>SELLOS DE VALVULA</b> <b>STEM SEALS</b>	<b>JUNTAS VARIAS</b> <b>MISCELLANEOUS</b>	N/A	
TC-6150-5	BS-7160	SS-8140-16P	N/A		

5.0L	MOTOR	MODELOS	DESDE / A	JUNTA DE CABEZA	MULTIPLE DE ADMISIÓN O PLENO
ENGINE	MODELS	FROM / TO	HEAD GASKET	INTAKE	
V8 OHV 16V 305" VORTEC VIN F H	CAMARO, FIRE-BIRD.	1987/1992	<b>CA-160-G</b> 	<b>MS-4150-6</b> 	
<b>FS-160-6</b>			<b>MULTIPLE DE ESCAPE</b> <b>EXHAUST</b> <b>MS-4150-E</b> 	<b>PUNTERIAS</b> <b>VALVE COVER</b> <b>VS-3150-1R</b> 	<b>CARTER</b> <b>OIL PAN</b> <b>OS-1150-1R</b> 
<b>DISTRIBUCIÓN</b> <b>TIMING COVER</b>	<b>RETÉN CIGÜEÑAL</b> <b>CRANK SEAL</b>	<b>SELLOS DE VALVULA</b> <b>STEM SEALS</b>	<b>JUNTAS VARIAS</b> <b>MISCELLANEOUS</b>	N/A	
TC-6150-5	BS-7160	SS-8140-16P	N/A		





5.3L	MOTOR	MODELOS	DESDE / A	JUNTA DE CABEZA	MULTIPLE DE ADMISIÓN O PLENO
ENGINE	MODELS	FROM / TO	HEAD GASKET	INTAKE	
V8 OHV 16V VIN VT	CHEYENNE, SILVERADO 1500, 2500, SUBURBAN, YUKON, SIERRA 1500, 2500, TAHOE (CABEZAS DE GRAFITO).	1999/2001	CA-175-G 	MS-4175-NS 	
FS-175-G 			MULTIPLE DE ESCAPE EXHAUST MS-4175-E 	PUNTERIAS VALVE COVER VS-3175-R 	CARTER OIL PAN OS-1175 
DISTRIBUCIÓN TIMING COVER TC-6175 	RETÉN CIGÜEÑAL CRANK SEAL BS-7175-NT 	SELLOS DE VALVULA STEM SEALS SS-8152-V 	JUNTAS VARIAS MISCELLANEOUS N/A	N/A	

5.3L	MOTOR	MODELOS	DESDE / A	JUNTA DE CABEZA	MULTIPLE DE ADMISIÓN O PLENO
ENGINE	MODELS	FROM / TO	HEAD GASKET	INTAKE	
V8 OHV 16V VIN TV	CHEYENNE, SILVERADO 1500, 2500, SUBURBAN, YUKON, SIERRA 1500, 2500, TAHOE (CABEZAS DE ML5).	1999/2001	CA-175-ML 	MS-4175-NS 	
FS-175-ML 			MULTIPLE DE ESCAPE EXHAUST MS-4175-E 	PUNTERIAS VALVE COVER VS-3175-R 	CARTER OIL PAN OS-1175-1R 
DISTRIBUCIÓN TIMING COVER TC-6175-LS 	RETÉN CIGÜEÑAL CRANK SEAL BS-7175-NT 	SELLOS DE VALVULA STEM SEALS SS-8152-V 	JUNTAS VARIAS MISCELLANEOUS N/A	N/A	



5.3L	MOTOR	MODELOS	DESDE / A	JUNTA DE CABEZA	MÚLTIPLE DE ADMISIÓN O PLENO
ENGINE	MODELS	FROM / TO	HEAD GASKET	INTAKE	
V8 OHV 16V VORTEC VIN T ZV 3	SUBURBAN, SILVERADO 1500, 2500, SIERRA 1500, 2500, YUKON, AVALANCHE, SAVANA, EXPRESS VAN 1500, 2500, SONORA.	2002/2009	<b>CA-175-G</b> 	<b>MS-4175-1NS</b> 	
<b>FS-175-1G</b>			<b>MÚLTIPLE DE ESCAPE</b> <b>EXHAUST</b> <b>MS-4175-E</b> 	<b>PUNTERIAS</b> <b>VALVE COVER</b> <b>VS-3175-R</b> 	<b>CARTER</b> <b>OIL PAN</b> <b>OS-1175</b> 
<b>DISTRIBUCIÓN</b> <b>TIMING COVER</b> <b>TC-6175</b> 	<b>RETÉN CIGÜEÑAL</b> <b>CRANK SEAL</b> <b>BS-7175-NT</b> 	<b>SELLOS DE VALVULA</b> <b>STEM SEALS</b> <b>SS-8152-1V</b> 	<b>JUNTAS VARIAS</b> <b>MISCELLANEOUS</b> <b>N/A</b>		

5.7L	MOTOR	MODELOS	DESDE / A	JUNTA DE CABEZA	MÚLTIPLE DE ADMISIÓN O PLENO
ENGINE	MODELS	FROM / TO	HEAD GASKET	INTAKE	
V8 OHV 16V VORTEC MEXICO TBI	MICROBUS, SUBURBAN, C-2500, C-3500, PICK-UP SOLO MEXICO.	1992/1998	<b>CA-150-G</b> 	<b>MS-4150-6</b> 	
<b>FS-150-M</b>			<b>MÚLTIPLE DE ESCAPE</b> <b>EXHAUST</b> <b>MS-4150-E</b> 	<b>PUNTERIAS</b> <b>VALVE COVER</b> <b>VS-3150-1R</b> 	<b>CARTER</b> <b>OIL PAN</b> <b>OS-1150</b> 
<b>DISTRIBUCIÓN</b> <b>TIMING COVER</b> <b>TC-6150-5</b> 	<b>RETÉN CIGÜEÑAL</b> <b>CRANK SEAL</b> <b>BS-7150-R</b> 	<b>SELLOS DE VALVULA</b> <b>STEM SEALS</b> <b>SS-8140-16P</b> 	<b>JUNTAS VARIAS</b> <b>MISCELLANEOUS</b> 		



5.7L	MOTOR	MODELOS	DESDE / A	JUNTA DE CABEZA	MULTIPLE DE ADMISIÓN O PLENO
ENGINE	MODELS	FROM / TO	HEAD GASKET	INTAKE	
V8 OHV 16V VORTEC VIN R K	SUBURBAN, YUKON, EXPRESS VAN 1500, 2500, 3500, SILVERADO 1500, 2500, SONORA, TAHOE, ESCALADE.	1996/2002	CA-150-G 	MS-4150-8 	
FS-150-10 			MULTIPLE DE ESCAPE EXHAUST MS-4150-3E 	PUNTERIAS VALVE COVER VS-3150-1R 	CARTER OIL PAN OS-1150-1R 
DISTRIBUCIÓN TIMING COVER TC-6150-5 	RETÉN CIGÜEÑAL CRANK SEAL BS-7160-1T 	SELLOS DE VALVULA STEM SEALS SS-8160-16V 	JUNTAS VARIAS MISCELLANEOUS N/A	N/A	

5.7L	MOTOR	MODELOS	DESDE / A	JUNTA DE CABEZA	MULTIPLE DE ADMISIÓN O PLENO
ENGINE	MODELS	FROM / TO	HEAD GASKET	INTAKE	
V8 OHV 16V 350"	MALIBU, MONTE CARLO, IMPALA, CHEVELLE, CORVETTE, CAPRICE, CAMARO, PICK UP C10, C20, C30, SUBURBAN.	1973/1991	CA-150-G 	MS-4150-3 	
FS-150-5 			MULTIPLE DE ESCAPE EXHAUST MS-4150-E 	PUNTERIAS VALVE COVER VS-3150 	CARTER OIL PAN OS-1150 
DISTRIBUCIÓN TIMING COVER TC-6150-5 	RETÉN CIGÜEÑAL CRANK SEAL BS-7150-R 	SELLOS DE VALVULA STEM SEALS SS-8140-16P 	JUNTAS VARIAS MISCELLANEOUS N/A	N/A	





5.7L	MOTOR	MODELOS	DESDE / A	JUNTA DE CABEZA		MÚLTIPLE DE ADMISIÓN O PLENO
ENGINE	MODELS	FROM / TO	HEAD GASKET		INTAKE	
V8 OHV 16V 350"	PICK UP K10, K20, K30, C10, C20, C30, SUBURBAN, IMPALA, MICRO-BUS.	1981/1986	CA-150-G 		MS-4150-3 	
FS-150-6 			MÚLTIPLE DE ESCAPE	PUNTERIAS	CARTER	
			EXHAUST	VALVE COVER	OIL PAN	
			MS-4150-E 	VS-3150 	OS-1150-1R 	
DISTRIBUCIÓN		RETÉN CIGÜEÑAL	SELLOS DE VALVULA		JUNTAS VARIAS	N/A
TIMING COVER		CRANK SEAL	STEM SEALS		MISCELLANEOUS	
TC-6150-5		BS-7160 	SS-8140-16P 			

5.7L	MOTOR	MODELOS	DESDE / A	JUNTA DE CABEZA		MÚLTIPLE DE ADMISIÓN O PLENO
ENGINE	MODELS	FROM / TO	HEAD GASKET		INTAKE	
V8 OHV 16V 350"	AUTOS Y CAMIONES USA.	1987/1988	CA-150-G 		MS-4150-3 	
FS-150-7 			MÚLTIPLE DE ESCAPE	PUNTERIAS	CARTER	
			EXHAUST	VALVE COVER	OIL PAN	
			MS-4150-E 	VS-3150-1R 	OS-1150-1R 	
DISTRIBUCIÓN		RETÉN CIGÜEÑAL	SELLOS DE VALVULA		JUNTAS VARIAS	N/A
TIMING COVER		CRANK SEAL	STEM SEALS		MISCELLANEOUS	
TC-6150-5		BS-7160 	SS-8140-16P 			



5.7L	MOTOR	MODELOS	DESDE / A	JUNTA DE CABEZA	MULTIPLE DE ADMISIÓN O PLENO
ENGINE	MODELS	FROM / TO	HEAD GASKET	INTAKE	
V8 OHV 16V TBI	CAMIONETAS "TBI" C1500, C2500, C3500, V1500, V2500, V3500, K1500, K2500, K3500, YUKON, TAHOE, BLAZER.	1989/1996	CA-150-G 	MS-4150-6 	
FS-150-8 			MULTIPLE DE ESCAPE EXHAUST MS-4150-E 	PUNTERIAS VALVE COVER VS-3150-1R 	CARTER OIL PAN OS-1150-1R 
DISTRIBUCIÓN TIMING COVER TC-6150-5 	RETÉN CIGÜEÑAL CRANK SEAL BS-7160 	SELLOS DE VALVULA STEM SEALS SS-8140-16P 	JUNTAS VARIAS MISCELLANEOUS N/A	N/A	

5.7L	MOTOR	MODELOS	DESDE / A	JUNTA DE CABEZA	MULTIPLE DE ADMISIÓN O PLENO
ENGINE	MODELS	FROM / TO	HEAD GASKET	INTAKE	
V8 OHV 16V VIN P.	FIREBIRD, CAMARO Z28, CAPRICE.	1992/1997	CA-151-1G 	MS-4151 	
FS-151-1 			MULTIPLE DE ESCAPE EXHAUST MS-4151-E 	PUNTERIAS VALVE COVER VS-3150-1R 	CARTER OIL PAN OS-1150-1R 
DISTRIBUCIÓN TIMING COVER TC-6150-6 	RETÉN CIGÜEÑAL CRANK SEAL BS-7160 	SELLOS DE VALVULA STEM SEALS SS-8160-16V 	JUNTAS VARIAS MISCELLANEOUS N/A	N/A	



6.0L	MOTOR	MODELOS	DESDE / A	JUNTA DE CABEZA	MÚLTIPLE DE ADMISIÓN O PLENO
ENGINE	MODELS	FROM / TO	HEAD GASKET	INTAKE	
V8 OHV 16V VORTEC VIN U	SILVERADO 2500, SIERRA 2500, YUKON, EXPRESS VAN, CARGO VAN, SUBURBAN (CABEZA DE GRAFITO).	1999/2001	CA-176-G 	MS-4175-NS 	
FS-176-G 			MÚLTIPLE DE ESCAPE EXHAUST MS-4175-E 	PUNTERIAS VALVE COVER VS-3175-R 	CARTER OIL PAN OS-1175 
DISTRIBUCIÓN TIMING COVER TC-6175 	RETÉN CIGÜEÑAL CRANK SEAL BS-7175-NT 	SELLOS DE VALVULA STEM SEALS SS-8152-V 	JUNTAS VARIAS MISCELLANEOUS N/A	N/A	

6.0L	MOTOR	MODELOS	DESDE / A	JUNTA DE CABEZA	MÚLTIPLE DE ADMISIÓN O PLENO
ENGINE	MODELS	FROM / TO	HEAD GASKET	INTAKE	
V8 OHV 16V VORTEC VIN U	SILVERADO 2500, SIERRA 2500, YUKON, EXPRESS VAN, CARGO VAN, SUBURBAN (CABEZAS DE MLS).	1999/2001	CA-176-ML 	MS-4175-NS 	
FS-176-ML 			MÚLTIPLE DE ESCAPE EXHAUST MS-4175-E 	PUNTERIAS VALVE COVER VS-3175-R 	CARTER OIL PAN OS-1175-1R 
DISTRIBUCIÓN TIMING COVER TC-6175-LS 	RETÉN CIGÜEÑAL CRANK SEAL BS-7175-NT 	SELLOS DE VALVULA STEM SEALS SS-8152-V 	JUNTAS VARIAS MISCELLANEOUS N/A	N/A	









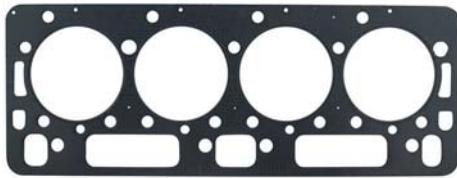

6.0L	MOTOR	MODELOS	DESDE / A	JUNTA DE CABEZA	MULTIPLE DE ADMISIÓN O PLENO
ENGINE	MODELS	FROM / TO	HEAD GASKET	INTAKE	
V8 OHV 16V VIN VORTEC N U Y K	SUBURBAN, YUKON, SIERRA 2500, SILVERADO 1500, 2500, 3500, EXPRESS VAN 2500, 3500, CORVETTE, AVALANCHE.	2001/2007	CA-176-G 	MS-4175-1NS 	
FS-176-1G 			MULTIPLE DE ESCAPE EXHAUST MS-4175-E 	PUNTERIAS VALVE COVER VS-3175-R 	CARTER OIL PAN OS-1175 
DISTRIBUCIÓN TIMING COVER TC-6175 	RETÉN CIGÜEÑAL CRANK SEAL BS-7175-NT 	SELLOS DE VALVULA STEM SEALS SS-8152-1V 	JUNTAS VARIAS MISCELLANEOUS N/A	N/A	

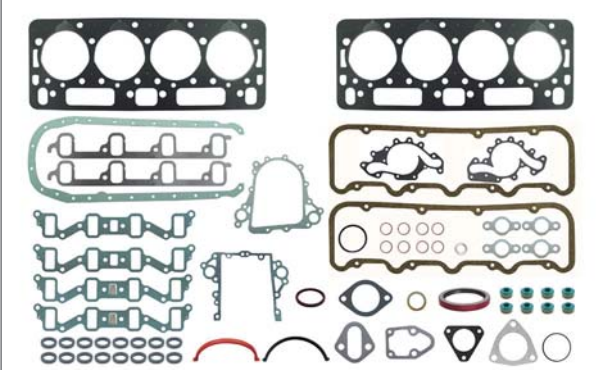
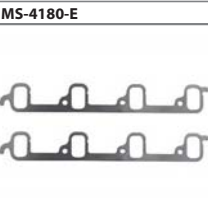
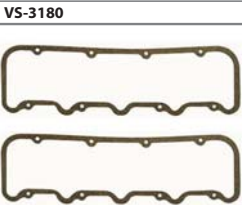
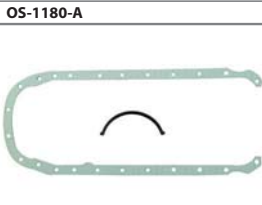
6.2L	MOTOR	MODELOS	DESDE / A	JUNTA DE CABEZA	MULTIPLE DE ADMISIÓN O PLENO
ENGINE	MODELS	FROM / TO	HEAD GASKET	INTAKE	
V8 OHV 16V VIN C X J	SUBURBAN 1500, 2500, 3500, PICK UP K1500, 2500, 3500, C1500, C2500, C3500, HUMMER, (DIESEL).	1982/1993	CA-179-G 	MS-4180-AD 	
FS-179 			MULTIPLE DE ESCAPE EXHAUST MS-4180-E 	PUNTERIAS VALVE COVER VS-3180 	CARTER OIL PAN OS-1180-1 
DISTRIBUCIÓN TIMING COVER TC-6180 	RETÉN CIGÜEÑAL CRANK SEAL BS-7179 	SELLOS DE VALVULA STEM SEALS SS-8180-V 	JUNTAS VARIAS MISCELLANEOUS N/A	N/A	

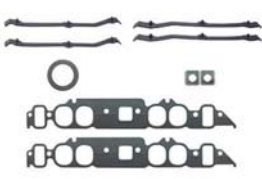

6.5L	MOTOR	MODELOS	DESDE / A	JUNTA DE CABEZA		MÚLTIPLE DE ADMISIÓN O PLENO
ENGINE	MODELS	FROM / TO	HEAD GASKET		INTAKE	
V8 OHV 16V VIN F P S Y Z	PICK UP C1500, C2500, C3500, K1500, K2500, K3500, EXPRESS 2500, 3500, SAVANA, YUKON, TAHOE, HUMMER H1, (DIESEL).	1994/2005				
<b>FS-180</b>						
						
MÚLTIPLE DE ESCAPE		PUNTERIAS		CARTER		
EXHAUST		VALVE COVER		OIL PAN		
						
DISTRIBUCIÓN	RETÉN CIGÜEÑAL	SELLOS DE VALVULA		JUNTAS VARIAS		N/A
TIMING COVER	CRANK SEAL	STEM SEALS		MISCELLANEOUS		
TC-6180	BS-7180-1	SS-8180-V		N/A		

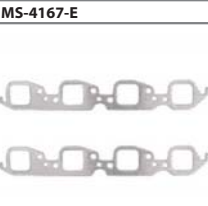
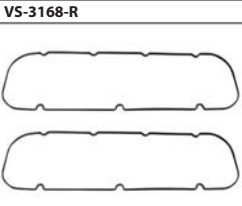
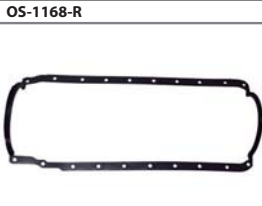
7.4L	MOTOR	MODELOS	DESDE / A	JUNTA DE CABEZA		MÚLTIPLE DE ADMISIÓN O PLENO
ENGINE	MODELS	FROM / TO	HEAD GASKET		INTAKE	
V8 OHV 16V VIN N	C1500, C2500, C3500, K2500, K3500.	1991/1996				
<b>FS-168-2</b>						
						
MÚLTIPLE DE ESCAPE		PUNTERIAS		CARTER		
EXHAUST		VALVE COVER		OIL PAN		
						
DISTRIBUCIÓN	RETÉN CIGÜEÑAL	SELLOS DE VALVULA		JUNTAS VARIAS		N/A
TIMING COVER	CRANK SEAL	STEM SEALS		MISCELLANEOUS		
TC-6167	BS-7168	** N/A **		N/A		



7.4L	MOTOR	MODELOS	DESDE / A	JUNTA DE CABEZA	MULTIPLE DE ADMISIÓN O PLENO
ENGINE	MODELS	FROM / TO	HEAD GASKET	INTAKE	
V8 OHV 16V 454" VORTEC VIN J	KODIAK C2500, C3500, K2500, K3500.	1996/2000	CA-169-G	MS-4169	
FS-169			MULTIPLE DE ESCAPE	PUNTERIAS	CARTER
			EXHAUST	VALVE COVER	OIL PAN
			MS-4169-E	VS-3168-R	OS-1168-R
DISTRIBUCIÓN	RETÉN CIGÜEÑAL	SELLOS DE VALVULA	JUNTAS VARIAS	N/A	
TIMING COVER	CRANK SEAL	STEM SEALS	MISCELLANEOUS		
TC-6169	BS-7168	SS-8167-NV	N/A		

8.1L	MOTOR	MODELOS	DESDE / A	JUNTA DE CABEZA	MULTIPLE DE ADMISIÓN O PLENO
ENGINE	MODELS	FROM / TO	HEAD GASKET	INTAKE	
V8 OHV 16V	SILVERADO, 2500HD, 3500, SIERRA 2500, 3500, YUKON, SUBURBAN, AVALANCHE, EXPRESS VAN.	2001/2007	CA-181-G Y CA-182-G	MS-4181	
			<p>PARA VER IMAGEN DIRIGIRSE A SECCIÓN DE JUNTAS DE CABEZA.</p> <p>TO SEE IMAGE GO TO HEAD GASKET SECTION</p>		
FS-181			MULTIPLE DE ESCAPE	PUNTERIAS	CARTER
			EXHAUST	VALVE COVER	OIL PAN
			MS-4181-E	VS-3181-R	OS-1181-R
DISTRIBUCIÓN	RETÉN CIGÜEÑAL	SELLOS DE VALVULA	JUNTAS VARIAS	N/A	
TIMING COVER	CRANK SEAL	STEM SEALS	MISCELLANEOUS		
TC-6181	BS-7181-PT	SS-8181-V	N/A		





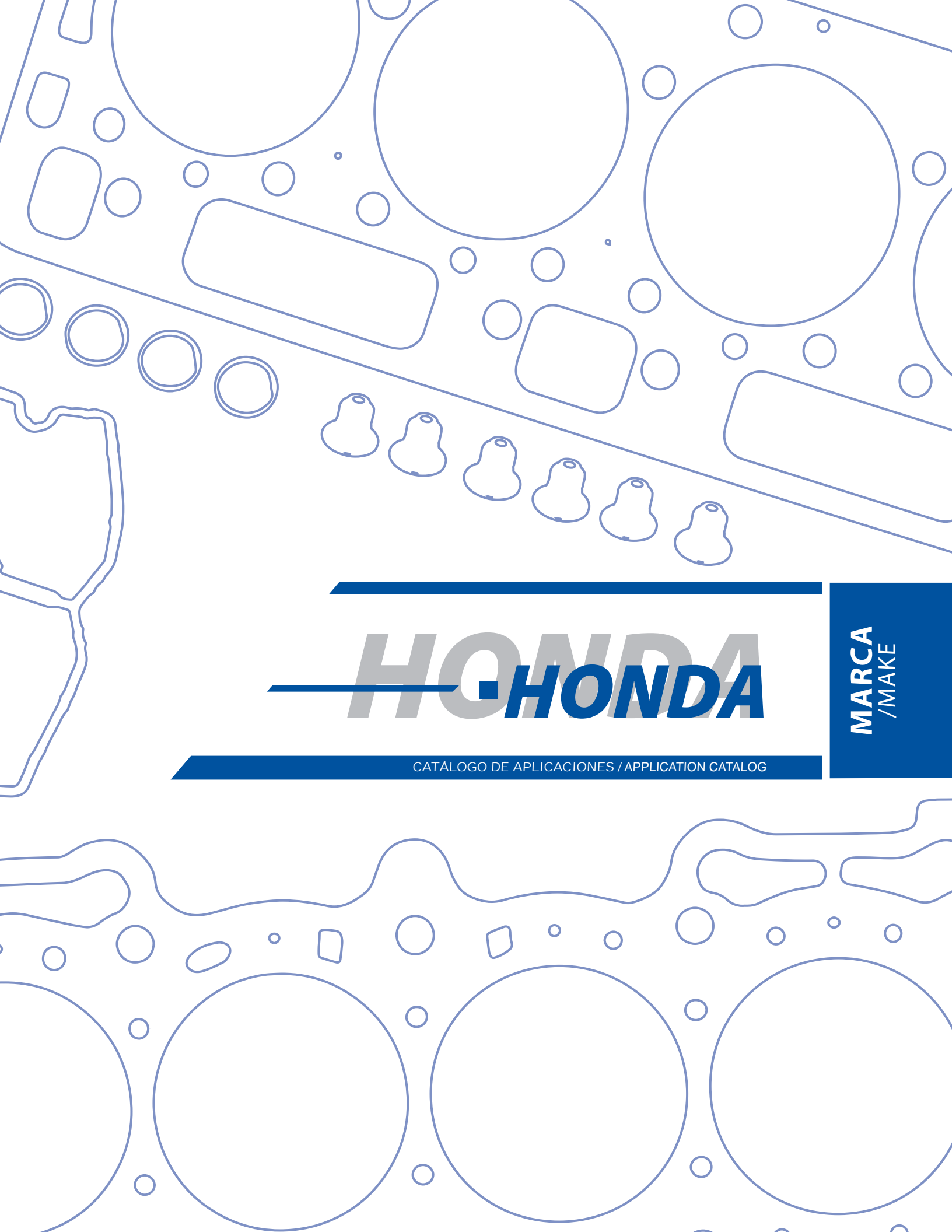

# HONDA

MARCA  
/MAKE

CATÁLOGO DE APLICACIONES / APPLICATION CATALOG





**HONDA**

LITROS	MODELO	AÑO	PÁGINA
LITERS	MODEL	YEAR	PAGE
1.2L	CIVIC.	1973/1979	*
1.3L	CIVIC.	1984/1987	*
1.5L	CIVIC.	1984/1991	*
1.5L	CIVIC.	1975/1983	*
1.5L	CIVIC (CABEZA DE GRAFITO).	1988/1995	*
1.5L	CIVIC (CABEZA DE MLS).	1992/1995	<b>137</b>
1.6L	CIVIC DEL SOL.	1994/2000	*
1.6L	CIVIC. ACURA EL (CABEZA DE GRAFITO).	1996/2000	*
1.6L	CIVIC , ACURA EL (CABEZA DE MLS).	1996/2000	<b>137</b>
1.7L	CIVIC, ACURA EL.	2001/2005	*
1.8L	ACURA INTEGRA.	1994/2001	*
1.8L	ACURA INTEGRA.	1990/1995	<b>138</b>
1.8L	CIVIC EX, DX, LXS.	2006/2009	*
2.0L	ACCORD, PRELUDE.	1985/1989	*
2.0L	CR-V.	1997/2001	*
2.2L	ACCORD, PRELUDE.	1990/1997	*
2.2L	ACCORD.	1990/1991	<b>138</b>
2.3L	ACCORD, ODYSSEY, ACURA CL.	1998/2002	*
2.3L	PRELUDE.	1992/1996	*
2.4L	CR-V.	2002/2006	*
2.4L	CR-V, ACCORD, ELEMENT, ACURA TSX.	2004/2010	*
2.7L	ACCORD.	1995/1997	*
3.0L	ACCORD , ACURA CL.	1997/2002	*
3.2L	ACURA LEGEND, TL.	1991/1998	*
3.2L	ACURA CL, TL.	1999/2003	*
3.2L	ACURA TL.	2004/2008	*
3.5L	PILOT, RIDGELINE, ODYSSEY, ACURA MDX.	2001/2009	*
3.5L	ACURA RL.	1996/2004	*
3.5L	ODYSSEY, PILOT, ACURA MDX.	1999/2004	*
3.5L	PILOT, ODYSSEY, RIDGELINE, ACURA MDX, SATURN VUE.	2003/2010	*
3.5L	ACCORD, ACCORD CROSSTOUR, PILOT, RIDGELINE, ODYSSEY, ACURA RDX, TSX, TL.	2008/2013	*





1.5L	MOTOR	MODELOS	DESDE / A	JUNTA DE CABEZA	MULTIPLE DE ADMISIÓN O PLENO
ENGINE	MODELS	FROM / TO	HEAD GASKET	INTAKE	
4L SOHC 8V y 16V D15B7, D15B8.	CIVIC (CABEZA DE MLS).	1992/1995	CA-1455-ML 	MS-41452-3 	
FS-1456 			MULTIPLE DE ESCAPE EXHAUST MS-41452-1E 	PUNTERIAS VALVE COVER VS-31452-2R 	CARTER OIL PAN OS-11450-R 
DISTRIBUCIÓN TIMING COVER TC-61452 	RETÉN CIGÜEÑAL CRANK SEAL BS-71452 	SELLOS DE VALVULA STEM SEALS SS-81452-V 	JUNTAS VARIAS MISCELLANEOUS		

1.6L	MOTOR	MODELOS	DESDE / A	JUNTA DE CABEZA	MULTIPLE DE ADMISIÓN O PLENO
ENGINE	MODELS	FROM / TO	HEAD GASKET	INTAKE	
4L SOHC 16V MOTOR VTEC D16Y5, D16Y7, D16Y8.	CIVIC, ACURA EL (CABEZA DE MLS).	1996/2000	CA-1455-ML 	MS-41455 	
FS-1455 			MULTIPLE DE ESCAPE EXHAUST MS-41452-1E 	PUNTERIAS VALVE COVER VS-31455 	CARTER OIL PAN OS-11455-1R 
DISTRIBUCIÓN TIMING COVER TC-61455-1 	RETÉN CIGÜEÑAL CRANK SEAL BS-71452 	SELLOS DE VALVULA STEM SEALS SS-81452-V 	JUNTAS VARIAS MISCELLANEOUS		





1.8L	MOTOR	MODELOS	DESDE / A	JUNTA DE CABEZA	MULTIPLE DE ADMISIÓN O PLENO
ENGINE	MODELS	FROM / TO	HEAD GASKET	INTAKE	
4L DOHC 16V B18A, 1B18C1.	ACURA INTEGRA.	1990/1995	CA-1458-ML 	MS-41451 	
FS-1458 			MULTIPLE DE ESCAPE EXHAUST	PUNTERIAS VALVE COVER	CARTER OIL PAN
DISTRIBUCIÓN TIMING COVER			SELLOS DE VALVULA STEM SEALS	JUNTAS VARIAS MISCELLANEOUS	
TC-61454	RETÉN CIGÜEÑAL CRANK SEAL	BS-71452 	SS-81452-V 		

2.2L	MOTOR	MODELOS	DESDE / A	JUNTA DE CABEZA	MULTIPLE DE ADMISIÓN O PLENO
ENGINE	MODELS	FROM / TO	HEAD GASKET	INTAKE	
4L SOHC 16V F22A4, F22A6, F22A1.	ACCORD.	1990/1991	CA-1457-ML 	MS-41457 	
FS-1457 			MULTIPLE DE ESCAPE EXHAUST	PUNTERIAS VALVE COVER	CARTER OIL PAN
DISTRIBUCIÓN TIMING COVER			SELLOS DE VALVULA STEM SEALS	JUNTAS VARIAS MISCELLANEOUS	
TC-61457	RETÉN CIGÜEÑAL CRANK SEAL	BS-71452 	SS-81452-V 		

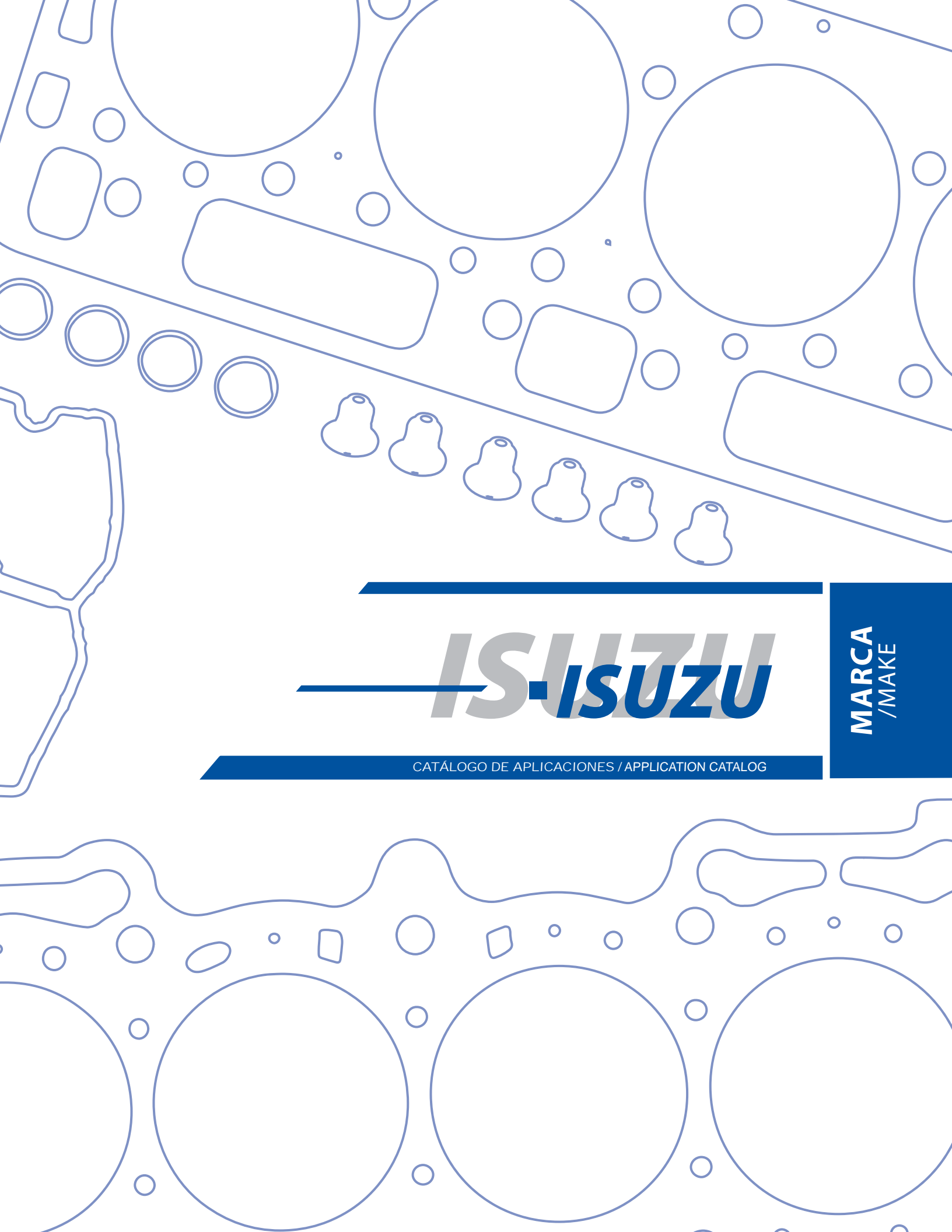

**ISUZU**

**MARCA  
/MAKE**

CATÁLOGO DE APLICACIONES / APPLICATION CATALOG







LITROS	MODELO	AÑO	PÁGINA
LITERS	MODEL	YEAR	PAGE
<b>2.3L</b>	AMIGO, TROOPER, IMPULSE, PICK UP.	1986/1995	<b>143</b>
<b>2.6L</b>	RODEO, TROOPER, AMIGO.	1988/1997	<b>143</b>
<b>3.0L</b>	ISUZU ELF SERIES 200/300.	2008/2013	*
<b>3.2L</b>	RODEO, TROOPER, HONDA PASSPORT.	1992/1995	<b>144</b>
<b>3.2L</b>	RODEO, AMIGO, TROOPER, AXIOM, VehiCROSS, HONDA PASSPORT.	1988/2003	*
<b>3.5L</b>	RODEO, AMIGO, TROOPER, AXIOM, VehiCROSS, HONDA PASSPORT.	1998/2003	*









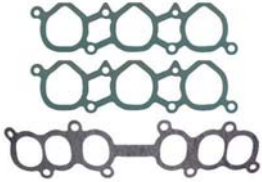
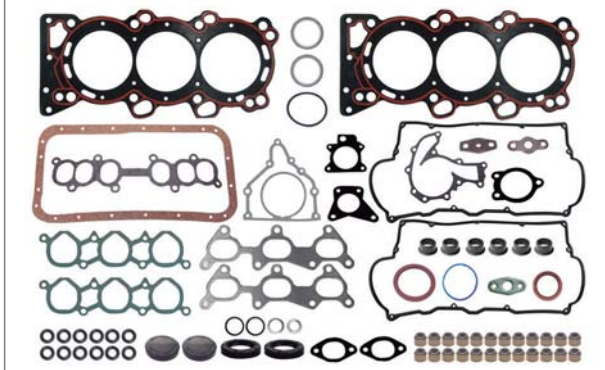

2.3L	MOTOR	MODELOS	DESDE / A	JUNTA DE CABEZA	MULTIPLE DE ADMISIÓN O PLENO
ENGINE	MODELS	FROM / TO	HEAD GASKET	INTAKE	
4L SOHC 8V MOTOR 4ZD1 VIN L	AMIGO, TROOPER, IMPULSE, PICK UP.	1986/1995	CA-1710-G 	MS-41710 	
FS-1710 			MULTIPLE DE ESCAPE EXHAUST	PUNTERIAS VALVE COVER	CARTER OIL PAN
DISTRIBUCIÓN TIMING COVER	RETÉN CIGÜEÑAL CRANK SEAL	SELLOS DE VALVULA STEM SEALS	JUNTAS VARIAS MISCELLANEOUS		
TC-61710-1 	BS-71710 	SS-81218 			

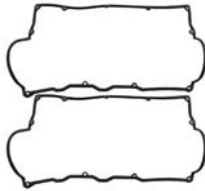
2.6L	MOTOR	MODELOS	DESDE / A	JUNTA DE CABEZA	MULTIPLE DE ADMISIÓN O PLENO
ENGINE	MODELS	FROM / TO	HEAD GASKET	INTAKE	
4L SOHC 8V 4ZE1 VIN E.	RODEO, TROOPER, AMIGO.	1988/1997	CA-1720-G 	MS-41710 	
FS-1720 			MULTIPLE DE ESCAPE EXHAUST	PUNTERIAS VALVE COVER	CARTER OIL PAN
DISTRIBUCIÓN TIMING COVER	RETÉN CIGÜEÑAL CRANK SEAL	SELLOS DE VALVULA STEM SEALS	JUNTAS VARIAS MISCELLANEOUS		
TC-61710-1 	BS-71710 	SS-81218 			



3.2L	MOTOR	MODELOS	DESDE / A	JUNTA DE CABEZA		MÚLTIPLE DE ADMISIÓN O PLENO
ENGINE		MODELS	FROM / TO	HEAD GASKET		INTAKE
V6 SOHC 24V VIN V		RODEO, TROOPER, HONDA PASSPORT.	1992/1995	<b>CA-1750-G</b> 		<b>MS-41750-A</b> 
<b>FS-1750-G</b>						
				<b>MÚLTIPLE DE ESCAPE</b> <b>EXHAUST</b> <b>MS-41750-E</b> 	<b>PUNTERIAS</b> <b>VALVE COVER</b> <b>VS-31750-R</b> 	<b>CARTER</b> <b>OIL PAN</b> <b>OS-11750</b> 
<b>DISTRIBUCIÓN</b> <b>TIMING COVER</b> <b>TC-61750</b>		<b>RETÉN CIGÜEÑAL</b> <b>CRANK SEAL</b> <b>BS-71750</b>		<b>SELLOS DE VALVULA</b> <b>STEM SEALS</b> <b>SS-8319-V</b>		<b>JUNTAS VARIAS</b> <b>MISCELLANEOUS</b>



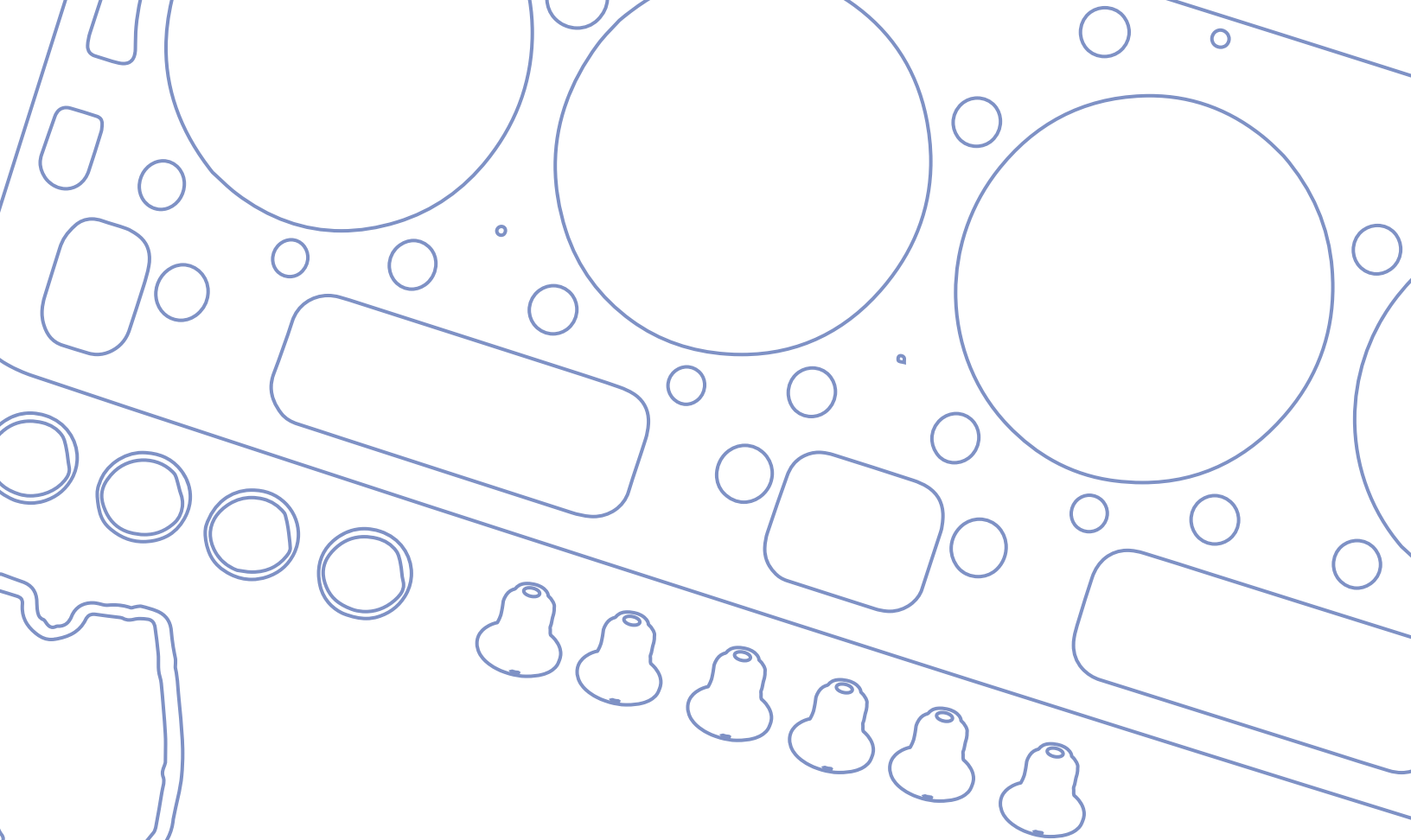

# MAZDA

MARCA  
/MAKE

CATÁLOGO DE APLICACIONES / APPLICATION CATALOG

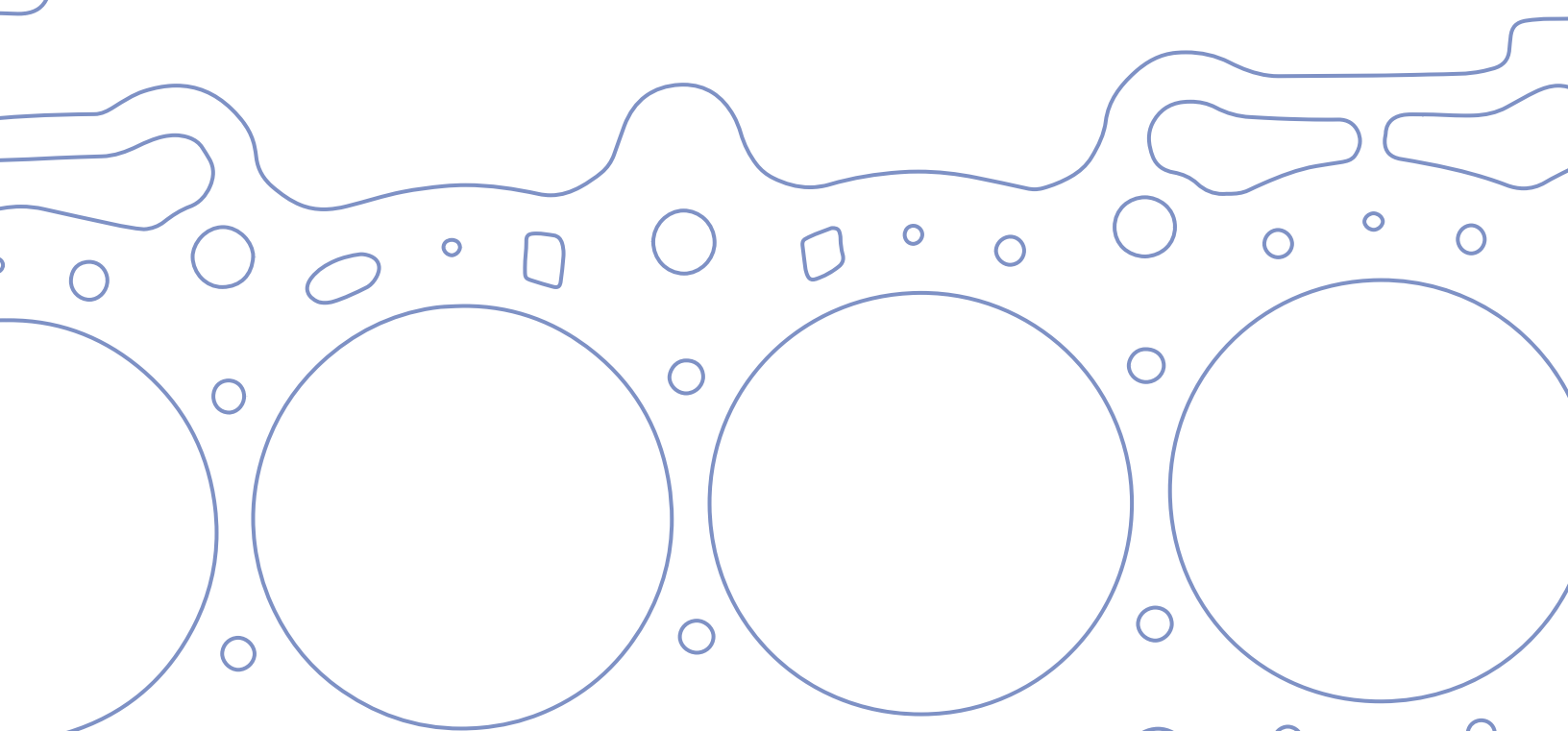





LITROS	MODELO	AÑO	PÁGINA
LITERS	MODEL	YEAR	PAGE
<b>1.3L</b>	MODELOS GLC.	1980/1987	<b>149</b>
<b>1.5L</b>	MODELOS GLC.	1980/1987	<b>149</b>
<b>1.6L</b>	MIATA, CAPRI, 323, MX-5.	1988/1994	*
<b>1.6L</b>	323, MERCURY TRACER.	1986/1989	*
<b>1.8L</b>	MIATA.	2001/2005	*
<b>2.0L</b>	PICK UP B2000, 626.	1983/1987	<b>150</b>
<b>2.0L</b>	626, PROTEGE, PROBE, MX-6.	1993/1997	<b>150</b>
<b>2.2L</b>	626, MX-6, FORD PROBE.	1988/1992	<b>151</b>
<b>2.6L</b>	PICK-UP B2600, MPV.	1989/1994	<b>151</b>
<b>3.0L</b>	929, MPV.	1989/1998	<b>152</b>







1.3L	MOTOR	MODELOS	DESDE / A	JUNTA DE CABEZA		MULTIPLE DE ADMISIÓN O PLENO	
ENGINE	MODELS	FROM / TO	HEAD GASKET		INTAKE		
4L SOHC 8V MOTOR E3	MODELOS GLC.	1980/1987					
<b>FS-1105</b>							
MULTIPLE DE ESCAPE		PUNTERIAS		CARTER			
EXHAUST		VALVE COVER		OIL PAN			
		VS-31105-R					
DISTRIBUCIÓN		RETÉN CIGÜEÑAL		SELLOS DE VALVULA		JUNTAS VARIAS	
TIMING COVER		CRANK SEAL		STEM SEALS		MISCELLANEOUS	
				SS-81108			

1.5L	MOTOR	MODELOS	DESDE / A	JUNTA DE CABEZA		MULTIPLE DE ADMISIÓN O PLENO	
ENGINE	MODELS	FROM / TO	HEAD GASKET		INTAKE		
4L SOHC 8V MOTOR E5	MODELOS GLC.	1980/1987					
<b>FS-1105</b>							
MULTIPLE DE ESCAPE		PUNTERIAS		CARTER			
EXHAUST		VALVE COVER		OIL PAN			
		VS-31105-R					
DISTRIBUCIÓN		RETÉN CIGÜEÑAL		SELLOS DE VALVULA		JUNTAS VARIAS	
TIMING COVER		CRANK SEAL		STEM SEALS		MISCELLANEOUS	
				SS-81108			



2.0L	MOTOR	MODELOS	DESDE / A	JUNTA DE CABEZA	MULTIPLE DE ADMISIÓN O PLENO
ENGINE	MODELS	FROM / TO	HEAD GASKET	INTAKE	
4L SOHC 8V MOTOR "FE" y "F8"	PICK UP B2000, 626.	1983/1987	CA-1110-G	MS-41110	
<b>FS-1110</b> 			 	 	
DISTRIBUCIÓN	RETÉN CIGÜEÑAL	SELLOS DE VALVULA	JUNTAS VARIAS		
TIMING COVER	CRANK SEAL	STEM SEALS	MISCELLANEOUS		
TC-61110	BS-71110	SS-8304-V			

2.0L	MOTOR	MODELOS	DESDE / A	JUNTA DE CABEZA	MULTIPLE DE ADMISIÓN O PLENO
ENGINE	MODELS	FROM / TO	HEAD GASKET	INTAKE	
4L DOHC 16V	626, PROTEGE, PROBE, MX-6.	1993/1997	CA-1112-ML	MS-41112	
<b>FS-1112</b> 			 	 	
DISTRIBUCIÓN	RETÉN CIGÜEÑAL	SELLOS DE VALVULA	JUNTAS VARIAS		
TIMING COVER	CRANK SEAL	STEM SEALS	MISCELLANEOUS		
TC-6319	BS-71112	SS-8109-S			



2.2L	MOTOR	MODELOS	DESDE / A	JUNTA DE CABEZA	MULTIPLE DE ADMISIÓN O PLENO
ENGINE	MODELS	FROM / TO	HEAD GASKET	INTAKE	
4L SOHC 12V MOTOR F2	626, MX-6, FORD PROBE.	1988/1992	CA-1120-G 		
FS-1120 					
			MULTIPLE DE ESCAPE	PUNTERIAS	CARTER
			EXHAUST	VALVE COVER	OIL PAN
			MS-41120-E 	VS-31120-R 	OS-11110 
DISTRIBUCIÓN		RETÉN CIGÜEÑAL	SELLOS DE VALVULA	JUNTAS VARIAS	
TIMING COVER		CRANK SEAL	STEM SEALS	MISCELLANEOUS	
		BS-71110 	SS-81120-V 		

2.6L	MOTOR	MODELOS	DESDE / A	JUNTA DE CABEZA	MULTIPLE DE ADMISIÓN O PLENO
ENGINE	MODELS	FROM / TO	HEAD GASKET	INTAKE	
4L SOHC 12V MOTOR G6	PICK-UP B2600, MPV.	1989/1994	CA-1125-G 	MS-41125-A 	
FS-1125 					
			MULTIPLE DE ESCAPE	PUNTERIAS	CARTER
			EXHAUST	VALVE COVER	OIL PAN
			MS-41125-E 	VS-31125-R 	OS-11125 
DISTRIBUCIÓN		RETÉN CIGÜEÑAL	SELLOS DE VALVULA	JUNTAS VARIAS	
TIMING COVER		CRANK SEAL	STEM SEALS	MISCELLANEOUS	
			SS-81125 		



3.0L	MOTOR	MODELOS	DESDE / A	JUNTA DE CABEZA	MULTIPLE DE ADMISIÓN O PLENO
ENGINE	MODELS	FROM / TO	HEAD GASKET	INTAKE	
V6 SOHC 24V	929, MPV.	1989/1998	<p>CA-1130-ML / CA-1131-ML</p> <p>PARA VER IMAGEN DIRIGIRSE A SECCIÓN DE JUNTAS DE CABEZA.</p> <p>TO SEE IMAGE GO TO HEAD GASKET SECTION</p>		
FS-1130					
				MULTIPLE DE ESCAPE	PUNTERIAS
				EXHAUST	VALVE COVER
					CARTER
					OIL PAN
DISTRIBUCIÓN		RETÉN CIGÜEÑAL		SELLOS DE VALVULA	JUNTAS VARIAS
TIMING COVER		CRANK SEAL		STEM SEALS	MISCELLANEOUS



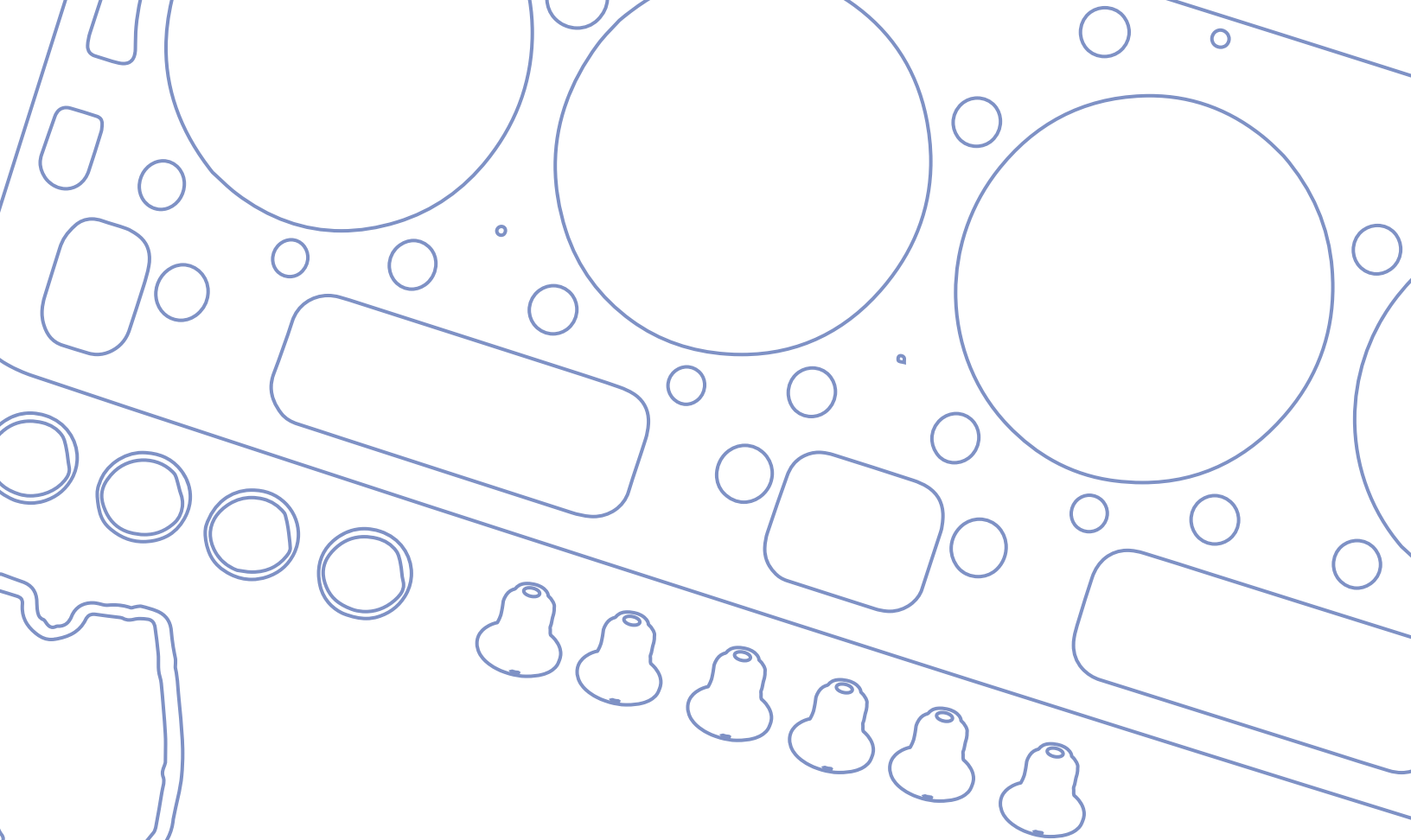

# **NISSAN**

**MARCA  
/MAKE**

CATÁLOGO DE APLICACIONES / APPLICATION CATALOG

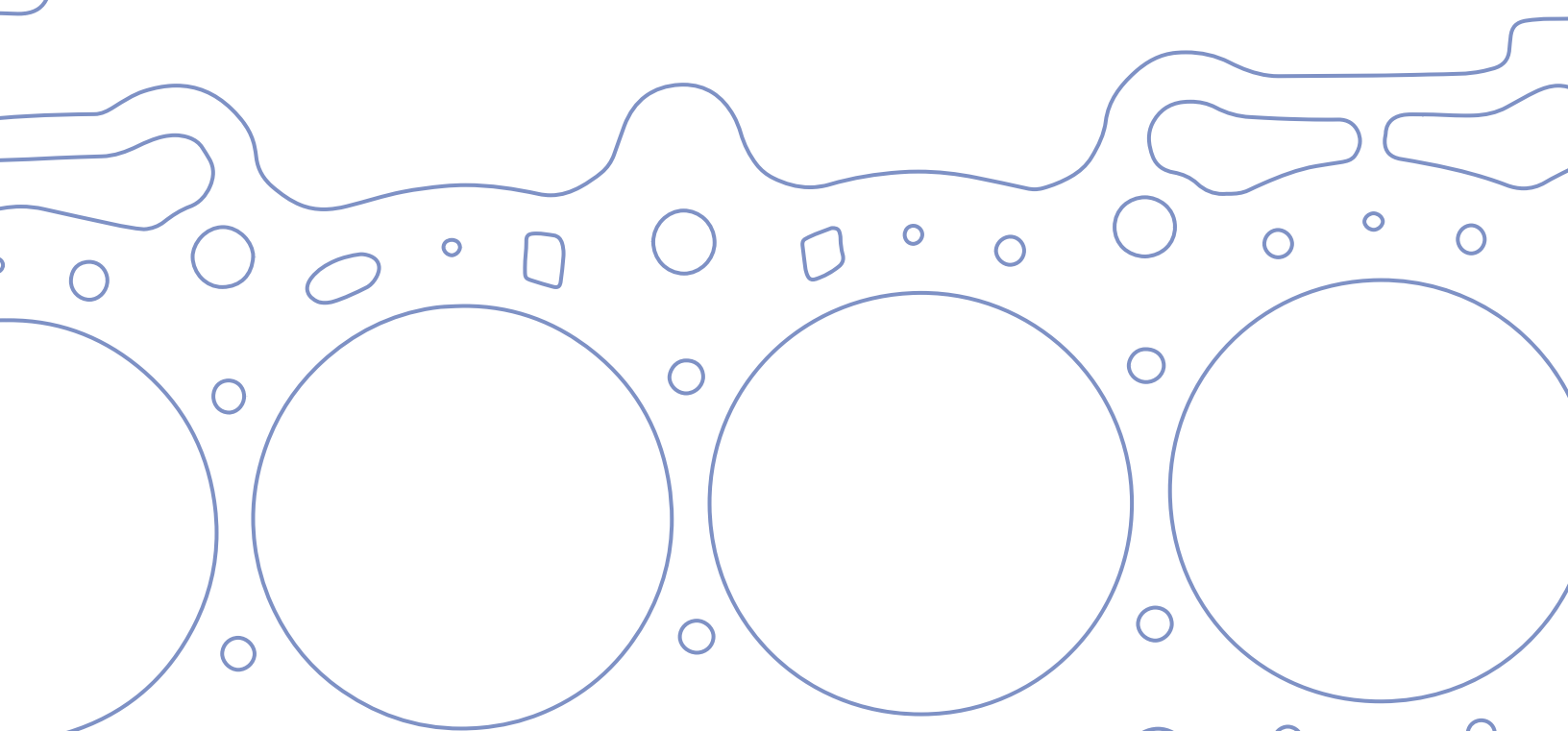





LITROS	MODELO	AÑO	PÁGINA
LITERS	MODEL	YEAR	PAGE
1.2L	AUTOS & CAMIONETAS.	1959/1969	157
1.2L	AUTOS AMERICANOS.	1980/1982	*
1.3L	AUTOS & CAMIONETAS.	1959/1969	*
1.4L	AUTOS AMERICANOS.	1979/1982	157
1.5L	DATSUN PICK UP, VAGONETA, SEDAN.	1970/1983	158
1.5L	AUTOS AMERICANOS.	1979/1982	158
1.5L	TSURU I.	1983/1987	159
1.6L	DATSUN PICK UP, VAGONETA, SEDAN.	1970/1984	159
1.6L	TSURU II.	1984/1992	160
1.6L	TSURU III, TSUBAME, 200SX, SENTRA, LUCINO.	1991/1996	160
1.6L	TSURU III GSI, GSII, SENTRA MEXICO, TSUBAME.	1997/2014	161
1.6L	SENTRA AMERICANO, PULSAR NX.	1989/1990	161
1.6L	MARCH, VERSA.	2012/2014	162
1.8L	200SX, STANZA.	1982/1988	*
1.8L	SAKURA, ESTAQUITAS, PICK- UP, ICHIVAN (USA).	1980/1994	162
1.8L	PICK-UP, ESTAQUITAS, SAKURA (MEXICO).	1981/1993	163
1.8L	SENTRA, (CABEZA DE GRAFITO).	2000/2003	163
1.8L	SENTRA (CABEZA DE MLS).	2000/2003	*
1.8L	ALMERA, SENTRA.	2000/2006	164
1.8L	TIIDA, SENTRA, VERSA.	2007/2011	164
2.0L	200SX, STANZA.	1982/1988	*
2.0L	200SX, PICK UP 720, 710, 620, 510.	1977/1980	165
2.0L	200SX, PICK UP 510.	1980/1981	165
2.0L	PICK UP 720.	1983/1986	166
2.0L	200SX, LUCINO, SENTRA, TSURU 2000 GSR.	1992/2000	166
2.0L	SENTRA.	2007/2009	167
2.2L	PICK UP 720, 200SX.	1981/1983	167
2.4L	CAMIONETAS VAN, PICK-UP 720, D21.	1983/1989	168
2.4L	ICHI VAN, PICK-UP D21, ESTAQUITAS.	1990/1998	168
2.4L	FRONTIER, PICK UP, URVAN.	2000/2006	169
2.4L	SOLO AUTOS ALTIMA.	1993/1999	169
2.5L	X-TRAIL, ALTIMA, SENTRA (CABEZA DE GRAFITO).	2002/2006	170
2.5L	X-TRAIL, ALTIMA, SENTRA (CABEZA DE MLS).	2002/2006	170
2.5L	CABSTAR TDI.	2008/2010	171
2.5L	ALTIMA, SENTRA, URVAN, FRONTIER, ROGUE.	2007/2009	*
2.5L	URVAN, FRONTIER, EQUATOR.	2005/2012	*
3.0L	QUEST, MERCURY VILLAGER.	1993/1998	171
3.0L	MAXIMA, INFINITI I30.	2000/2001	*
3.0L	URVAN TURBODIESEL.	2001/2009	*
3.0L	MAXIMA, INFINITI I30.	1995/1999	*
3.3L	PATHFINDER, FRONTIER, X-TERRA.	1996/2004	172
3.5L	MAXIMA, ALTIMA, MURANO, QUEST, 350Z, INFINITI G35, I35.	2002/2008	*
3.5L	PATHFINDER, INFINITI, QX4, FX35.	2001/2004	*
5.6L	ARMADA, TITAN, PATHFINDER (CABEZA DE GRAFITO).	2004/2010	*
5.6L	TITAN, ARMADA, PATHFINDER (CABEZA DE GRAFITO).	2004/2010	172







1.2L	MOTOR	MODELOS	DESDE / A	JUNTA DE CABEZA	MULTIPLE DE ADMISIÓN O PLENO
ENGINE	MODELS	FROM / TO	HEAD GASKET	INTAKE	
4L OHV 8V MOTOR J	AUTOS & CAMIONETAS.	1959/1969	CA-1200-G 	MS-41200 	
FS-1200 			MULTIPLE DE ESCAPE EXHAUST	PUNTERIAS VALVE COVER	CARTER OIL PAN
			N/A	VS-31200 	OS-11200 
DISTRIBUCIÓN TIMING COVER		RETÉN CIGÜEÑAL CRANK SEAL		SELLOS DE VALVULA STEM SEALS	JUNTAS VARIAS MISCELLANEOUS
TC-61200		BS-71200			

1.4L	MOTOR	MODELOS	DESDE / A	JUNTA DE CABEZA	MULTIPLE DE ADMISIÓN O PLENO
ENGINE	MODELS	FROM / TO	HEAD GASKET	INTAKE	
4L OHV 8V MOTOR A14	AUTOS AMERICANOS.	1979/1982	CA-1213-G 	MS-41213 	
FS-1213 			MULTIPLE DE ESCAPE EXHAUST	PUNTERIAS VALVE COVER	CARTER OIL PAN
			N/A	VS-31213 	OS-11213 
DISTRIBUCIÓN TIMING COVER		RETÉN CIGÜEÑAL CRANK SEAL		SELLOS DE VALVULA STEM SEALS	JUNTAS VARIAS MISCELLANEOUS
TC-61213		BS-71213		SS-81215 	



1.5L	MOTOR	MODELOS	DESDE / A	JUNTA DE CABEZA		MÚLTIPLE DE ADMISIÓN O PLENO
ENGINE	MODELS	FROM / TO	HEAD GASKET		INTAKE	
4L OHV 8V MOTOR J15	DATSUN PICK UP, VAGONETA, SEDAN.	1970/1983	CA-1210-GX		MS-41200	
<b>FS-1210</b> 						
DISTRIBUCIÓN		RETÉN CIGÜEÑAL	SELLOS DE VALVULA		JUNTAS VARIAS	
TIMING COVER		CRANK SEAL	STEM SEALS		MISCELLANEOUS	
TC-61200-1		BS-71200				

1.5L	MOTOR	MODELOS	DESDE / A	JUNTA DE CABEZA		MÚLTIPLE DE ADMISIÓN O PLENO
ENGINE	MODELS	FROM / TO	HEAD GASKET		INTAKE	
4L OHV 8V MOTOR A15	AUTOS AMERICANOS.	1979/1982	CA-1213-G		MS-41213	
<b>FS-1213</b> 						
DISTRIBUCIÓN		RETÉN CIGÜEÑAL	SELLOS DE VALVULA		JUNTAS VARIAS	
TIMING COVER		CRANK SEAL	STEM SEALS		MISCELLANEOUS	
TC-61213		BS-71213				



1.5L	MOTOR	MODELOS	DESDE / A	JUNTA DE CABEZA	MULTIPLE DE ADMISIÓN O PLENO
ENGINE	MODELS	FROM / TO	HEAD GASKET	INTAKE	
4L SOHC 8V E15	TSURU I.	1983/1987	CA-1216-G 	MS-41216-A 	
FS-1216 			MULTIPLE DE ESCAPE EXHAUST MS-41216-E 	PUNTERIAS VALVE COVER VS-31216-R 	CARTER OIL PAN OS-12116 
DISTRIBUCIÓN TIMING COVER TC-61216 	RETÉN CIGÜEÑAL CRANK SEAL BS-71216 	SELLOS DE VALVULA STEM SEALS SS-81216 	JUNTAS VARIAS MISCELLANEOUS 		

1.6L	MOTOR	MODELOS	DESDE / A	JUNTA DE CABEZA	MULTIPLE DE ADMISIÓN O PLENO
ENGINE	MODELS	FROM / TO	HEAD GASKET	INTAKE	
4L OHV 8V MOTOR J16	DATSUN PICK UP, VAGONETA, SEDAN.	1970/1984	CA-1210-GX 	MS-41200 	
FS-1210-1 			MULTIPLE DE ESCAPE EXHAUST	PUNTERIAS VALVE COVER VS-31210 	CARTER OIL PAN OS-11200 
DISTRIBUCIÓN TIMING COVER TC-61200-1 	RETÉN CIGÜEÑAL CRANK SEAL BS-71200 	SELLOS DE VALVULA STEM SEALS SS-81210 	JUNTAS VARIAS MISCELLANEOUS		





1.6L	MOTOR	MODELOS	DESDE / A	JUNTA DE CABEZA	MULTIPLE DE ADMISIÓN O PLENO
ENGINE	MODELS	FROM / TO	HEAD GASKET	INTAKE	
4L SOHC 8V E16	TSURU II.	1984/1992	CA-1216-G 	MS-41216-A 	
FS-1216 			MULTIPLE DE ESCAPE EXHAUST	PUNTERIAS VALVE COVER	CARTER OIL PAN
DISTRIBUCIÓN TIMING COVER			SELLOS DE VALVULA STEM SEALS	JUNTAS VARIAS MISCELLANEOUS	
TC-61216 	RETÉN CIGÜEÑAL CRANK SEAL	BS-71216 	SS-81216 	1216 	

1.6L	MOTOR	MODELOS	DESDE / A	JUNTA DE CABEZA	MULTIPLE DE ADMISIÓN O PLENO
ENGINE	MODELS	FROM / TO	HEAD GASKET	INTAKE	
4L DOHC 16V GA16DE MOTOR JAPONES	TSURU III, TSUBAME, 200SX, SENTRA, LUCINO.	1991/1996	CA-1226-G 	MS-41226 	
FS-1226 			MULTIPLE DE ESCAPE EXHAUST	PUNTERIAS VALVE COVER	CARTER OIL PAN
DISTRIBUCIÓN TIMING COVER			SELLOS DE VALVULA STEM SEALS	JUNTAS VARIAS MISCELLANEOUS	
TC-61226 	RETÉN CIGÜEÑAL CRANK SEAL	BS-71226 	SS-81226-V 	1226 	













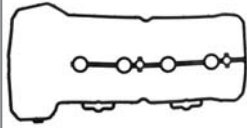

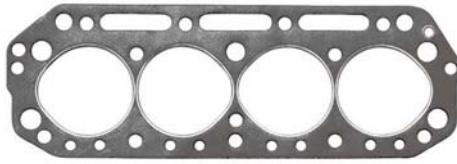

1.6L	MOTOR	MODELOS	DESDE / A	JUNTA DE CABEZA	MULTIPLE DE ADMISIÓN O PLENO
ENGINE	MODELS	FROM / TO	HEAD GASKET	INTAKE	
4L DOHC 16V GA16DE GA16DNE	TSURU III GSI, GSII, SENTRA MEXICO, TSUBAME.	1997/2014	CA-1226-1G 	MS-41226-1 	
FS-1226-1 			MULTIPLE DE ESCAPE EXHAUST MS-41226-E 	PUNTERIAS VALVE COVER VS-31226-1R 	CARTER OIL PAN OS-11216 
DISTRIBUCIÓN TIMING COVER TC-61226 	RETÉN CIGÜEÑAL CRANK SEAL BS-71226 	SELLOS DE VALVULA STEM SEALS SS-81226-V 	JUNTAS VARIAS MISCELLANEOUS 		

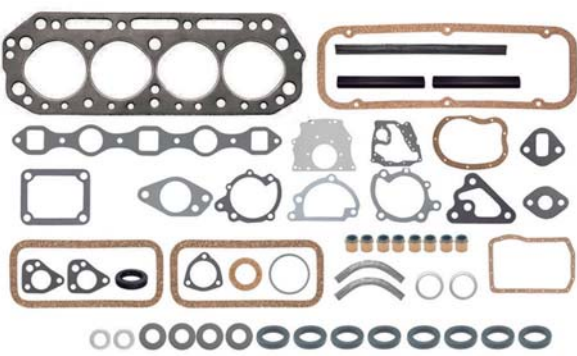
1.6L	MOTOR	MODELOS	DESDE / A	JUNTA DE CABEZA	MULTIPLE DE ADMISIÓN O PLENO
ENGINE	MODELS	FROM / TO	HEAD GASKET	INTAKE	
4L SOHC 12 V MOTOR GA16I	SENTRA AMERICANO, PULSAR NX.	1989/1990	CA-1227-G 	MS-41227 	
FS-1227 			MULTIPLE DE ESCAPE EXHAUST MS-41227-E 	PUNTERIAS VALVE COVER VS-31227-R 	CARTER OIL PAN OS-11226 
DISTRIBUCIÓN TIMING COVER TC-61226 	RETÉN CIGÜEÑAL CRANK SEAL BS-71226 	SELLOS DE VALVULA STEM SEALS SS-81227 	JUNTAS VARIAS MISCELLANEOUS 		



1.6L	MOTOR	MODELOS	DESDE / A	JUNTA DE CABEZA	MULTIPLE DE ADMISIÓN O PLENO
ENGINE	MODELS	FROM / TO	HEAD GASKET	INTAKE	
4L DOHC 16 V 98" HR16DE	MARCH, VERSA.	2012/2014	<p>CA-1242-2ML</p> 		
<p>FS-1242-ML</p> 			<p>MULTIPLE DE ESCAPE</p> <p>EXHAUST</p>	<p>PUNTERIAS</p> <p>VALVE COVER</p> <p>VS-31242-R</p> 	<p>CARTER</p> <p>OIL PAN</p>
<p>DISTRIBUCIÓN</p> <p>TIMING COVER</p>		<p>RETÉN CIGÜEÑAL</p> <p>CRANK SEAL</p> <p>BS-71242-V</p> 	<p>SELLOS DE VALVULA</p> <p>STEM SEALS</p>	<p>JUNTAS VARIAS</p> <p>MISCELLANEOUS</p>	

1.8L	MOTOR	MODELOS	DESDE / A	JUNTA DE CABEZA	MULTIPLE DE ADMISIÓN O PLENO
ENGINE	MODELS	FROM / TO	HEAD GASKET	INTAKE	
4L OHV 8V MOTOR J18	SAKURA, ESTAQUITAS, PICK-UP, ICHIVAN (USA).	1980/1994	<p>CA-1215-G</p> 	<p>MS-41215</p> 	
<p>FS-1215</p> 			<p>MULTIPLE DE ESCAPE</p> <p>EXHAUST</p> <p>** N/A **</p> <p>N/A</p>	<p>PUNTERIAS</p> <p>VALVE COVER</p> <p>VS-31210</p> 	<p>CARTER</p> <p>OIL PAN</p> <p>OS-11200</p> 
<p>DISTRIBUCIÓN</p> <p>TIMING COVER</p> <p>TC-61200-1</p> 		<p>RETÉN CIGÜEÑAL</p> <p>CRANK SEAL</p> <p>BS-71200</p> 	<p>SELLOS DE VALVULA</p> <p>STEM SEALS</p> <p>SS-81215</p> 	<p>JUNTAS VARIAS</p> <p>MISCELLANEOUS</p>	













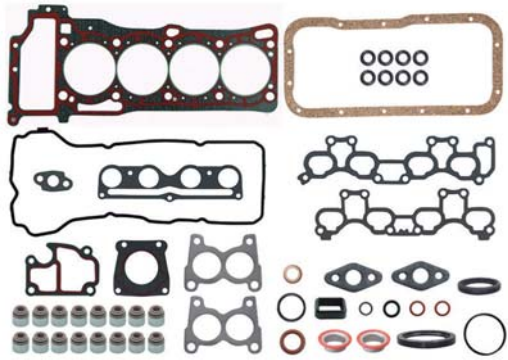

1.8L	MOTOR	MODELOS	DESDE / A	JUNTA DE CABEZA	MULTIPLE DE ADMISIÓN O PLENO
ENGINE	MODELS	FROM / TO	HEAD GASKET	INTAKE	
4L OHV 8V MOTOR J18 MEXICO	PICK-UP, ESTAQUITAS, SAKURA (MEXICO).	1981/1993	CA-1215-G 	MS-41215 	
FS-1215-1 			MULTIPLE DE ESCAPE EXHAUST ** N/A ** N/A	PUNTERIAS VALVE COVER VS-31210 	CARTER OIL PAN OS-11200 
DISTRIBUCIÓN TIMING COVER TC-61200-1 	RETÉN CIGÜEÑAL CRANK SEAL BS-71200 	SELLOS DE VALVULA STEM SEALS SS-81215 	JUNTAS VARIAS MISCELLANEOUS		

1.8L	MOTOR	MODELOS	DESDE / A	JUNTA DE CABEZA	MULTIPLE DE ADMISIÓN O PLENO
ENGINE	MODELS	FROM / TO	HEAD GASKET	INTAKE	
4L DOHC 16V QG18DE	SENTRA, (CABEZA DE GRAFITO).	2000/2003	CA-1234-G 	MS-41234 	
FS-1234 			MULTIPLE DE ESCAPE EXHAUST MS-41234-E 	PUNTERIAS VALVE COVER VS-31234-R 	CARTER OIL PAN OS-11226 
DISTRIBUCIÓN TIMING COVER ** N/A **	RETÉN CIGÜEÑAL CRANK SEAL BS-71226 	SELLOS DE VALVULA STEM SEALS SS-81226-V 	JUNTAS VARIAS MISCELLANEOUS		



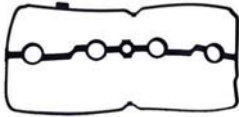

1.8L	MOTOR	MODELOS	DESDE / A	JUNTA DE CABEZA	MULTIPLE DE ADMISIÓN O PLENO
ENGINE	MODELS	FROM / TO	HEAD GASKET	INTAKE	
4L DOHC 16V QG18DE	ALMERA, SENTRA.	2000/2006	<p>CA-1234-G</p> 	<p>MS-41234</p> 	
<p>FS-1234-1</p> 			<p>MULTIPLE DE ESCAPE</p> <p>EXHAUST</p> <p>MS-41234-E</p> 	<p>PUNTERIAS</p> <p>VALVE COVER</p> <p>VS-31234-1R</p> 	<p>CARTER</p> <p>OIL PAN</p> <p>OS-11226</p> 
<p>DISTRIBUCIÓN</p> <p>TIMING COVER</p> <p>N/A</p>	N/A	<p>RETÉN CIGÜEÑAL</p> <p>CRANK SEAL</p> <p>BS-71226</p> 	<p>SELLOS DE VALVULA</p> <p>STEM SEALS</p> <p>SS-81226-V</p> 	<p>JUNTAS VARIAS</p> <p>MISCELLANEOUS</p>	

1.8L	MOTOR	MODELOS	DESDE / A	JUNTA DE CABEZA	MULTIPLE DE ADMISIÓN O PLENO
ENGINE	MODELS	FROM / TO	HEAD GASKET	INTAKE	
4L DOHC 16V MR18DE	TIIDA, SENTRA, VERSA.	2007/2011	<p>CA-1238-ML</p> 	<p>MS-41238</p> 	
<p>FS-1238</p> 			<p>MULTIPLE DE ESCAPE</p> <p>EXHAUST</p> <p>MS-41238-E</p> 	<p>PUNTERIAS</p> <p>VALVE COVER</p> <p>VS-31238-R</p> 	<p>CARTER</p> <p>OIL PAN</p> <p>N/A</p>
<p>DISTRIBUCIÓN</p> <p>TIMING COVER</p> <p>N/A</p>	N/A	<p>RETÉN CIGÜEÑAL</p> <p>CRANK SEAL</p>	<p>SELLOS DE VALVULA</p> <p>STEM SEALS</p> <p>N/A</p>	<p>JUNTAS VARIAS</p> <p>MISCELLANEOUS</p>	















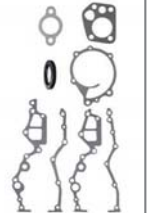

2.0L	MOTOR	MODELOS	DESDE / A	JUNTA DE CABEZA	MULTIPLE DE ADMISIÓN O PLENO
ENGINE	MODELS	FROM / TO	HEAD GASKET	INTAKE	
4L SOHC 8 VALV MOTOR L20B	200SX, PICK UP 720, 710, 620, 510.	1977/1980	CA-1218-G 	MS-41218-1 	
FS-1218 			MULTIPLE DE ESCAPE EXHAUST ** N/A ** N/A	PUNTERIAS VALVE COVER VS-31218 	CARTER OIL PAN OS-11218 
DISTRIBUCIÓN TIMING COVER TC-61218 	RETÉN CIGÜEÑAL CRANK SEAL BS-71218 	SELLOS DE VALVULA STEM SEALS SS-81218 	JUNTAS VARIAS MISCELLANEOUS		

2.0L	MOTOR	MODELOS	DESDE / A	JUNTA DE CABEZA	MULTIPLE DE ADMISIÓN O PLENO
ENGINE	MODELS	FROM / TO	HEAD GASKET	INTAKE	
4L SOHC 8V Z20E	200SX, PICK UP 510.	1980/1981	CA-1222-G 	MS-41222 	
FS-1222 			MULTIPLE DE ESCAPE EXHAUST MS-41222-E 	PUNTERIAS VALVE COVER VS-31222 	CARTER OIL PAN OS-11218 
DISTRIBUCIÓN TIMING COVER TC-61218 	RETÉN CIGÜEÑAL CRANK SEAL BS-71218 	SELLOS DE VALVULA STEM SEALS SS-81218 	JUNTAS VARIAS MISCELLANEOUS 		

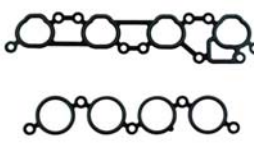

2.0L	MOTOR	MODELOS	DESDE / A	JUNTA DE CABEZA	MULTIPLE DE ADMISIÓN O PLENO
ENGINE	MODELS	FROM / TO	HEAD GASKET	INTAKE	
4L SOHC 8V Z20E	PICK UP 720.	1983/1986	CA-1222-G 	MS-41222 	
FS-1222-1			MULTIPLE DE ESCAPE EXHAUST MS-41222-E 	PUNTERIAS VALVE COVER VS-31222-1R 	CARTER OIL PAN OS-11218 
DISTRIBUCIÓN TIMING COVER TC-61218 	RETÉN CIGÜEÑAL CRANK SEAL BS-71218 	SELLOS DE VALVULA STEM SEALS SS-81218 	JUNTAS VARIAS MISCELLANEOUS		

2.0L	MOTOR	MODELOS	DESDE / A	JUNTA DE CABEZA	MULTIPLE DE ADMISIÓN O PLENO
ENGINE	MODELS	FROM / TO	HEAD GASKET	INTAKE	
4L DOHC 16V 122" SR20DE	200SX, LUCINO, SENTRA, TSURU 2000 GSR.	1992/2000	CA-1228-G 	MS-41228-A 	
FS-1228			MULTIPLE DE ESCAPE EXHAUST MS-41228-E 	PUNTERIAS VALVE COVER VS-31228-R 	CARTER OIL PAN OS-11228 
DISTRIBUCIÓN TIMING COVER N/A	RETÉN CIGÜEÑAL CRANK SEAL N/A	SELLOS DE VALVULA STEM SEALS SS-81227 	JUNTAS VARIAS MISCELLANEOUS		



2.0L	MOTOR	MODELOS	DESDE / A	JUNTA DE CABEZA	MULTIPLE DE ADMISIÓN O PLENO
ENGINE	MODELS	FROM / TO	HEAD GASKET	INTAKE	
4L DOHC 16V MR20DE	SENTRA.	2007/2009	CA-1238-ML 	MS-41238 	
FS-1238 			MULTIPLE DE ESCAPE EXHAUST MS-41238-E 	PUNTERIAS VALVE COVER VS-31238-R 	CARTER OIL PAN
DISTRIBUCIÓN TIMING COVER		RETÉN CIGÜEÑAL CRANK SEAL BS-71242-V 	SELLOS DE VALVULA STEM SEALS	JUNTAS VARIAS MISCELLANEOUS	

2.2L	MOTOR	MODELOS	DESDE / A	JUNTA DE CABEZA	MULTIPLE DE ADMISIÓN O PLENO
ENGINE	MODELS	FROM / TO	HEAD GASKET	INTAKE	
4L SOHC 8V Z22S	PICK UP 720, 200SX.	1981/1983	CA-1224-G 	MS-41222 	
FS-1223 			MULTIPLE DE ESCAPE EXHAUST MS-41222-E 	PUNTERIAS VALVE COVER VS-31322-R 	CARTER OIL PAN OS-11218 
DISTRIBUCIÓN TIMING COVER TC-61218		RETÉN CIGÜEÑAL CRANK SEAL BS-71218 	SELLOS DE VALVULA STEM SEALS SS-81218 	JUNTAS VARIAS MISCELLANEOUS	





2.4L	MOTOR	MODELOS	DESDE / A	JUNTA DE CABEZA	MULTIPLE DE ADMISIÓN O PLENO
ENGINE	MODELS	FROM / TO	HEAD GASKET	INTAKE	
4L SOHC 8V Z24I Z24S	CAMIONETAS VAN, PICK-UP 720, D21.	1983/1989	CA-1224-G	MS-41224	
<b>FS-1224</b>			<b>MULTIPLE DE ESCAPE</b> EXHAUST MS-41222-E	<b>PUNTERIAS</b> VALVE COVER VS-31222-1R	<b>CARTER</b> OIL PAN OS-11218
<b>DISTRIBUCIÓN</b> TIMING COVER TC-61224		<b>RETÉN CIGÜEÑAL</b> CRANK SEAL BS-71218		<b>SELLOS DE VALVULA</b> STEM SEALS SS-81218	
				<b>JUNTAS VARIAS</b> MISCELLANEOUS	

2.4L	MOTOR	MODELOS	DESDE / A	JUNTA DE CABEZA	MULTIPLE DE ADMISIÓN O PLENO
ENGINE	MODELS	FROM / TO	HEAD GASKET	INTAKE	
4L SOHC 12V KA24E KA24S	ICHI VAN, PICK-UP D21, ESTAQUITAS.	1990/1998	CA-1225-G	MS-41225	
<b>FS-1225</b>			<b>MULTIPLE DE ESCAPE</b> EXHAUST MS-41225-E	<b>PUNTERIAS</b> VALVE COVER VS-31225-R	<b>CARTER</b> OIL PAN OS-11225
<b>DISTRIBUCIÓN</b> TIMING COVER TC-61225		<b>RETÉN CIGÜEÑAL</b> CRANK SEAL BS-71216		<b>SELLOS DE VALVULA</b> STEM SEALS SS-81225-1	
				<b>JUNTAS VARIAS</b> MISCELLANEOUS	





2.4L	MOTOR	MODELOS	DESDE / A	JUNTA DE CABEZA	MULTIPLE DE ADMISIÓN O PLENO
ENGINE	MODELS	FROM / TO	HEAD GASKET	INTAKE	
4L DOHC 16V MOTOR KA24DE	FRONTIER, PICK UP, URVAN.	2000/2006	CA-1232-G 	MS-41232 	
FS-1232 			MULTIPLE DE ESCAPE EXHAUST MS-41232-E 	PUNTERIAS VALVE COVER VS-31232-R 	CARTER OIL PAN OS-11232 
DISTRIBUCIÓN TIMING COVER N/A	N/A	RETÉN CIGÜEÑAL CRANK SEAL BS-71226 	SELLOS DE VALVULA STEM SEALS SS-81225-1 	JUNTAS VARIAS MISCELLANEOUS	





2.4L	MOTOR	MODELOS	DESDE / A	JUNTA DE CABEZA	MULTIPLE DE ADMISIÓN O PLENO
ENGINE	MODELS	FROM / TO	HEAD GASKET	INTAKE	
4L DOHC 16V MOTOR KA24DE	SOLO AUTOS ALTIMA.	1993/1999	CA-1233-G 	MS-41233-A 	
FS-1233 			MULTIPLE DE ESCAPE EXHAUST MS-41232-E 	PUNTERIAS VALVE COVER VS-31233-R 	CARTER OIL PAN OS-11233 
DISTRIBUCIÓN TIMING COVER N/A	N/A	RETÉN CIGÜEÑAL CRANK SEAL BS-71216 	SELLOS DE VALVULA STEM SEALS SS-81225-1 	JUNTAS VARIAS MISCELLANEOUS	





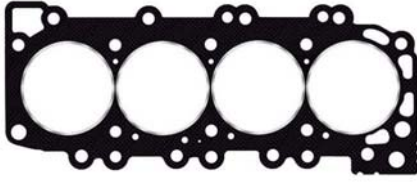

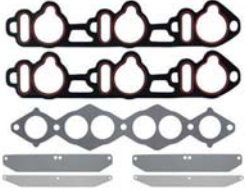

2.5L	MOTOR	MODELOS	DESDE / A	JUNTA DE CABEZA	MULTIPLE DE ADMISIÓN O PLENO
ENGINE	MODELS	FROM / TO	HEAD GASKET	INTAKE	
4L DOHC 16 V QR25DE	X-TRAIL, ALTIMA, SENTRA (CABEZA DE GRAFITO).	2002/2006	CA-1235-G 	MS-41235-A 	
FS-1235-G 			MULTIPLE DE ESCAPE EXHAUST MS-41235-E 	PUNTERIAS VALVE COVER VS-31235-R 	CARTER OIL PAN N/A
DISTRIBUCIÓN TIMING COVER N/A	N/A	RETÉN CIGÜEÑAL CRANK SEAL BS-71226 	SELLOS DE VALVULA STEM SEALS SS-81236-V 	JUNTAS VARIAS MISCELLANEOUS 1235	

2.5L	MOTOR	MODELOS	DESDE / A	JUNTA DE CABEZA	MULTIPLE DE ADMISIÓN O PLENO
ENGINE	MODELS	FROM / TO	HEAD GASKET	INTAKE	
4L DOHC 16V QR25DE	X-TRAIL, ALTIMA, SENTRA (CABEZA DE MLS).	2002/2006	CA-1235-ML 	MS-41235-A 	
FS-1235-ML 			MULTIPLE DE ESCAPE EXHAUST MS-41235-E 	PUNTERIAS VALVE COVER VS-31235-R 	CARTER OIL PAN N/A
DISTRIBUCIÓN TIMING COVER N/A	N/A	RETÉN CIGÜEÑAL CRANK SEAL BS-71226 	SELLOS DE VALVULA STEM SEALS SS-81236-V 	JUNTAS VARIAS MISCELLANEOUS 1235	



2.5L	MOTOR	MODELOS	DESDE / A	JUNTA DE CABEZA	MULTIPLE DE ADMISIÓN O PLENO
ENGINE	MODELS	FROM / TO	HEAD GASKET	INTAKE	
4L DOHC 16V YD25DDTI TURBODIESEL	CABSTAR TDI.	2008/2010	<p>CA-1241-GX</p> 	<p>MS-41241-HD</p> 	
<p>FS-1241-ML</p> 			<p>MULTIPLE DE ESCAPE</p> <p>EXHAUST</p> <p>MS-41241-E</p> 	<p>PUNTERIAS</p> <p>VALVE COVER</p>	<p>CARTER</p> <p>OIL PAN</p>
DISTRIBUCIÓN		RETÉN CIGÜEÑAL		SELLOS DE VALVULA	JUNTAS VARIAS
TIMING COVER		CRANK SEAL		STEM SEALS	MISCELLANEOUS

3.0L	MOTOR	MODELOS	DESDE / A	JUNTA DE CABEZA	MULTIPLE DE ADMISIÓN O PLENO
ENGINE	MODELS	FROM / TO	HEAD GASKET	INTAKE	
V6 SOHC 12V VG30 VG30E	QUEST, MERCURY VILLAGER.	1993/1998	<p>CA-1229-G</p> 	<p>MS-41229</p> 	
<p>FS-1229</p> 			<p>MULTIPLE DE ESCAPE</p> <p>EXHAUST</p> <p>MS-41229-E</p> 	<p>PUNTERIAS</p> <p>VALVE COVER</p> <p>VS-31229-R</p> 	<p>CARTER</p> <p>OIL PAN</p> <p>OS-11229-R</p> 
DISTRIBUCIÓN		RETÉN CIGÜEÑAL		SELLOS DE VALVULA	JUNTAS VARIAS
TIMING COVER	N/A	CRANK SEAL		STEM SEALS	MISCELLANEOUS
N/A		BS-71226		SS-81229	





3.3L	MOTOR	MODELOS	DESDE / A	JUNTA DE CABEZA	MÚLTIPLE DE ADMISIÓN O PLENO
ENGINE	MODELS	FROM / TO	HEAD GASKET	INTAKE	
V6 SOHC 12V VG33DE	PATHFINDER, FRONTIER, X-TERRA.	1996/2004	CA-1229-1G 	MS-41229 	
FS-1229-1 			MÚLTIPLE DE ESCAPE EXHAUST MS-41229-E 	PUNTERIAS VALVE COVER VS-31229-R 	CARTER OIL PAN OS-11229-R 
DISTRIBUCIÓN TIMING COVER	N/A	RETÉN CIGÜEÑAL CRANK SEAL BS-71226 	SELLOS DE VALVULA STEM SEALS SS-81229 	JUNTAS VARIAS MISCELLANEOUS	

5.6L	MOTOR	MODELOS	DESDE / A	JUNTA DE CABEZA	MÚLTIPLE DE ADMISIÓN O PLENO
ENGINE	MODELS	FROM / TO	HEAD GASKET	INTAKE	
V8 DOHC 32V VK56DE	TITAN, ARMADA, PATHFINDER (CABEZA DE GRATITO).	2004/2010	CA-1256-G / CA-1256-1G  PARA VER IMAGEN DIRIGIRSE A SECCIÓN DE JUNTAS DE CABEZA. TO SEE IMAGE GO TO HEAD GASKET SECTION		
FS-1256-ML 			MÚLTIPLE DE ESCAPE EXHAUST	PUNTERIAS VALVE COVER	CARTER OIL PAN
DISTRIBUCIÓN TIMING COVER		RETÉN CIGÜEÑAL CRANK SEAL	SELLOS DE VALVULA STEM SEALS	JUNTAS VARIAS MISCELLANEOUS	



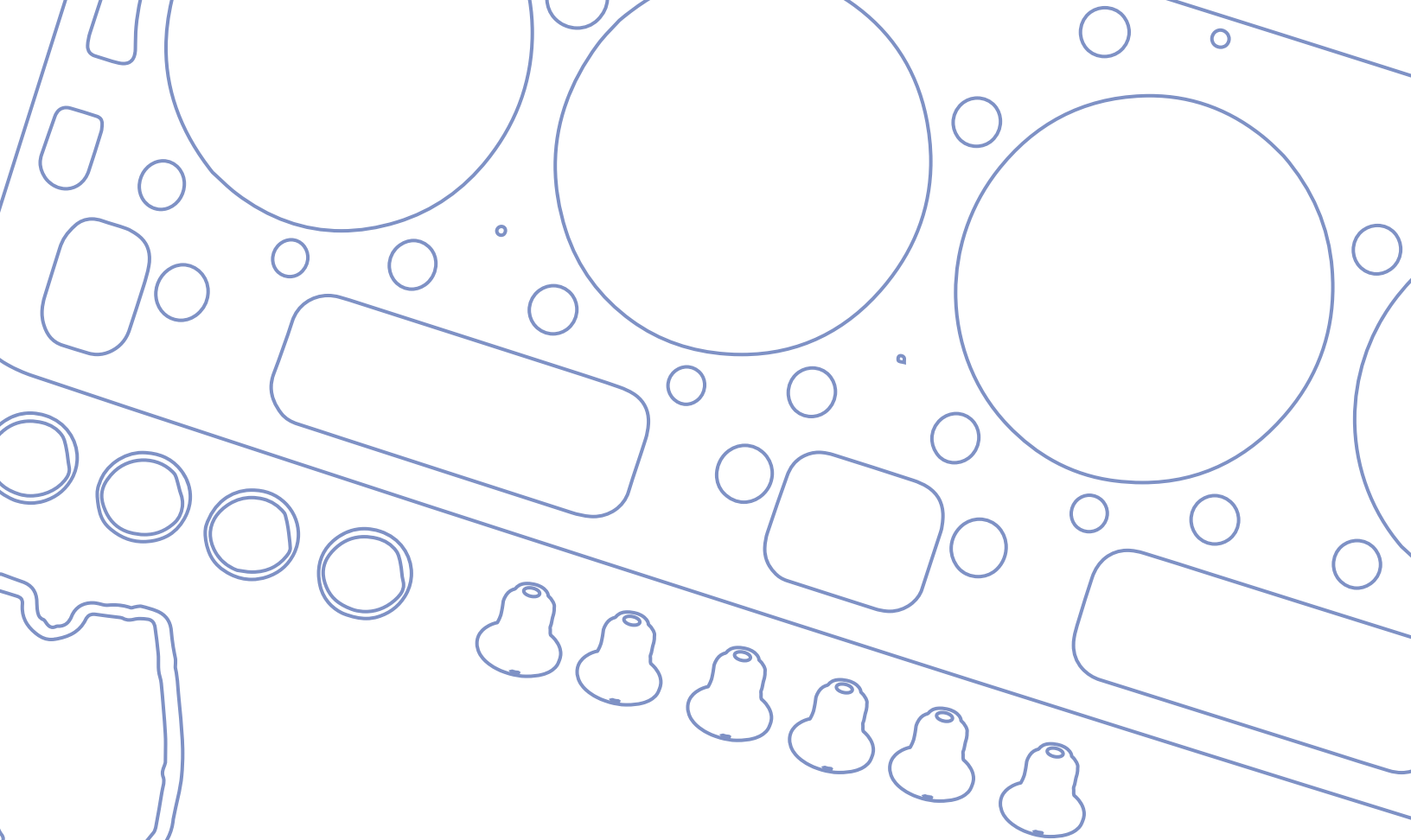

**— RENAIULT**

**MARCA  
/MAKE**

CATÁLOGO DE APLICACIONES / APPLICATION CATALOG

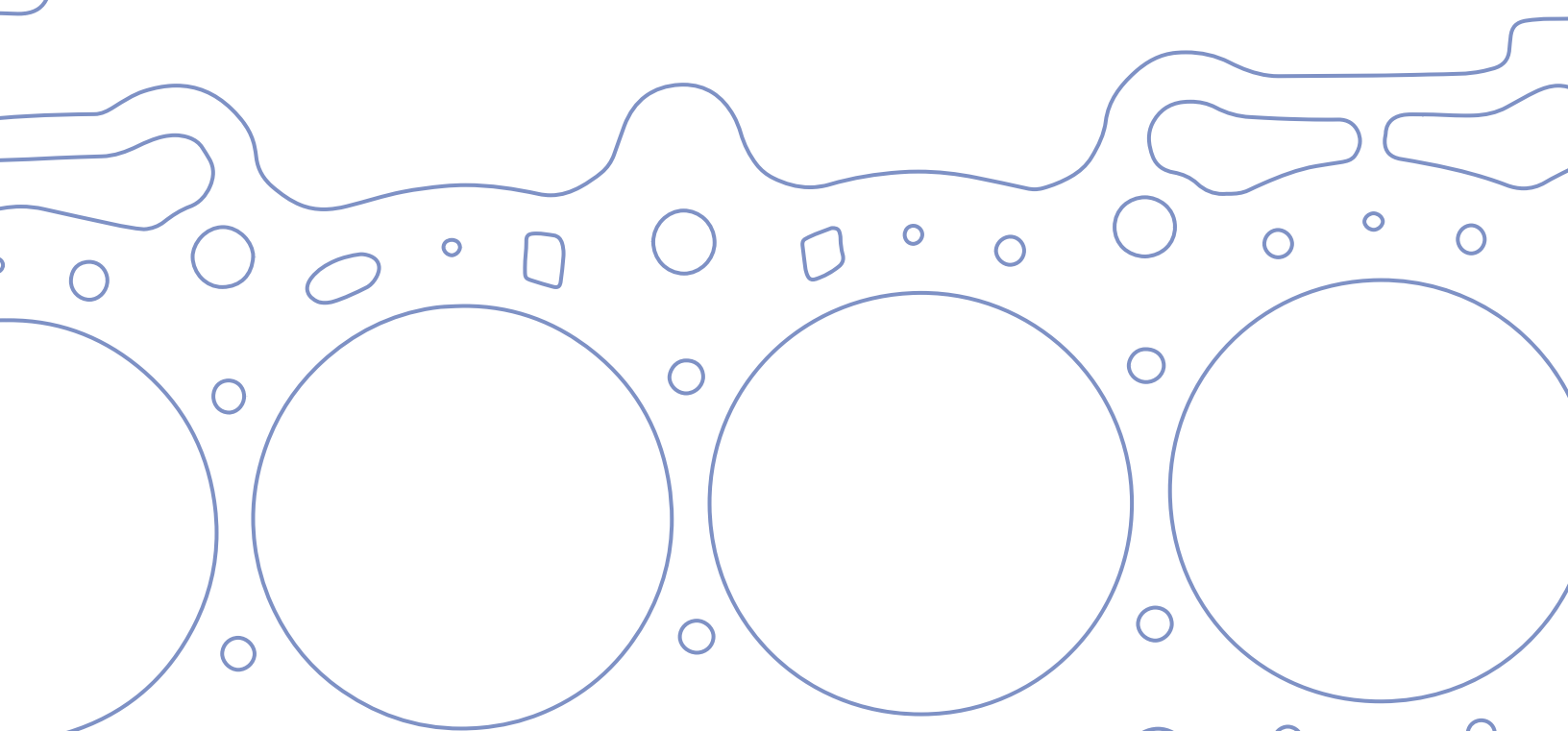





LITROS	MODELO	AÑO	PÁGINA
LITERS	MODEL	YEAR	PAGE
<b>1.1L</b>	R8, R10, MAJOR	1963/1969	<b>177</b>
<b>1.3L</b>	R5, R8, TL, TX, MIRAGE, 12 TL	1975/1984	<b>177</b>
<b>1.6L</b>	R12, R18, TS	1975/1984	<b>178</b>
<b>1.6L</b>	PLATINA, CLIO, KANGOO (CABEZA DE GRAFITO)	2002/2009	*
<b>1.6L</b>	PLATINA, CLIO, KANGOO	2002/2009	<b>178</b>







1.1L	MOTOR	MODELOS	DESDE / A	JUNTA DE CABEZA		MÚLTIPLE DE ADMISIÓN O PLENO	
ENGINE	MODELS	FROM / TO	HEAD GASKET		INTAKE		
4L OHV 8V	R8, R10, MAJOR	1963/1969	CA-1510-T		MS-41510-1		
FS-1510-1R			MÚLTIPLE DE ESCAPE		PUNTERIAS	CARTER	
			EXHAUST		VALVE COVER	OIL PAN	
			N/A		N/A	OS-11510-1	
			N/A		N/A		
DISTRIBUCIÓN		RETÉN CIGÜEÑAL		SELLOS DE VALVULA	N/A	JUNTAS VARIAS	
TIMING COVER		CRANK SEAL		STEM SEALS		MISCELLANEOUS	
TC-61510		BS-71800		N/A			

1.3L	MOTOR	MODELOS	DESDE / A	JUNTA DE CABEZA		MÚLTIPLE DE ADMISIÓN O PLENO	
ENGINE	MODELS	FROM / TO	HEAD GASKET		INTAKE		
4L OHV	R5, R8, TL, TX, MIRAGE, 12 TL	1975/1984	CA-1520-G		MS-41520		
FS-1520-1R			MÚLTIPLE DE ESCAPE		PUNTERIAS	CARTER	
			EXHAUST		VALVE COVER	OIL PAN	
					VS-31510-R	OS-11510	
DISTRIBUCIÓN		RETÉN CIGÜEÑAL		SELLOS DE VALVULA		JUNTAS VARIAS	
TIMING COVER		CRANK SEAL		STEM SEALS		MISCELLANEOUS	
TC-61510		BS-71300					



1.6L	MOTOR	MODELOS	DESDE / A	JUNTA DE CABEZA	MULTIPLE DE ADMISIÓN O PLENO
ENGINE	MODELS	FROM / TO	HEAD GASKET	INTAKE	
4L OHV	R12, R18, TS	1975/1984	CA-1530-G 	MS-41530 	
FS-1530 			MULTIPLE DE ESCAPE EXHAUST	PUNTERIAS VALVE COVER	CARTER OIL PAN
DISTRIBUCIÓN TIMING COVER			SELLOS DE VALVULA STEM SEALS		JUNTAS VARIAS MISCELLANEOUS
TC-61530 	RETÉN CIGÜEÑAL CRANK SEAL	BS-71300 			

1.6L	MOTOR	MODELOS	DESDE / A	JUNTA DE CABEZA	MULTIPLE DE ADMISIÓN O PLENO
ENGINE	MODELS	FROM / TO	HEAD GASKET	INTAKE	
4L DOHC 16V K4M-690	PLATINA, CLIO, KANGOO	2002/2009	CA-1550-ML 	MS-41550 	
FS-1550 			MULTIPLE DE ESCAPE EXHAUST	PUNTERIAS VALVE COVER	CARTER OIL PAN
DISTRIBUCIÓN TIMING COVER			SELLOS DE VALVULA STEM SEALS		JUNTAS VARIAS MISCELLANEOUS
	RETÉN CIGÜEÑAL CRANK SEAL	BS-71216 	SS-81550-V 		

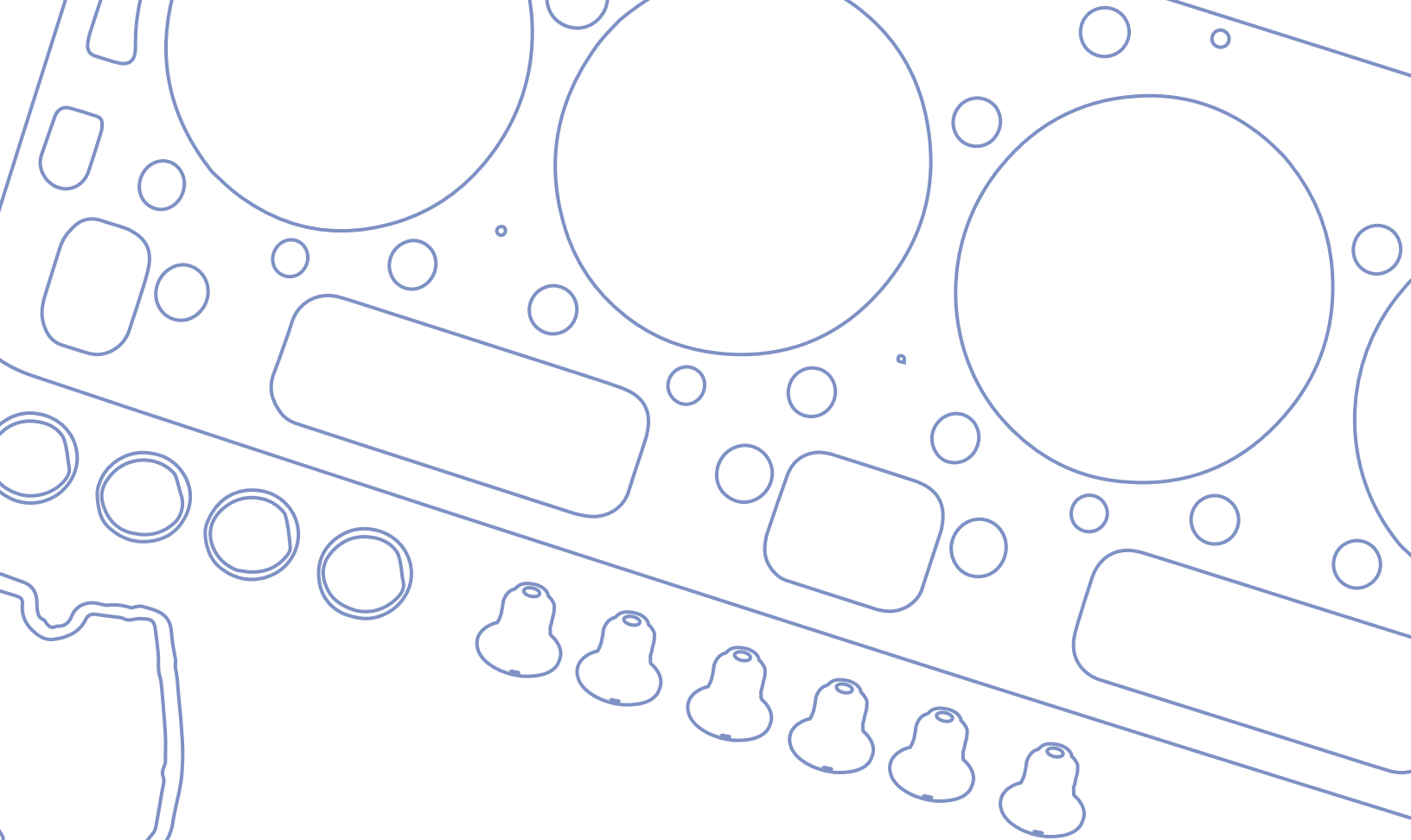

# TOYOTA

# TOYOTA

MARCA  
/MAKE

CATÁLOGO DE APLICACIONES / APPLICATION CATALOG

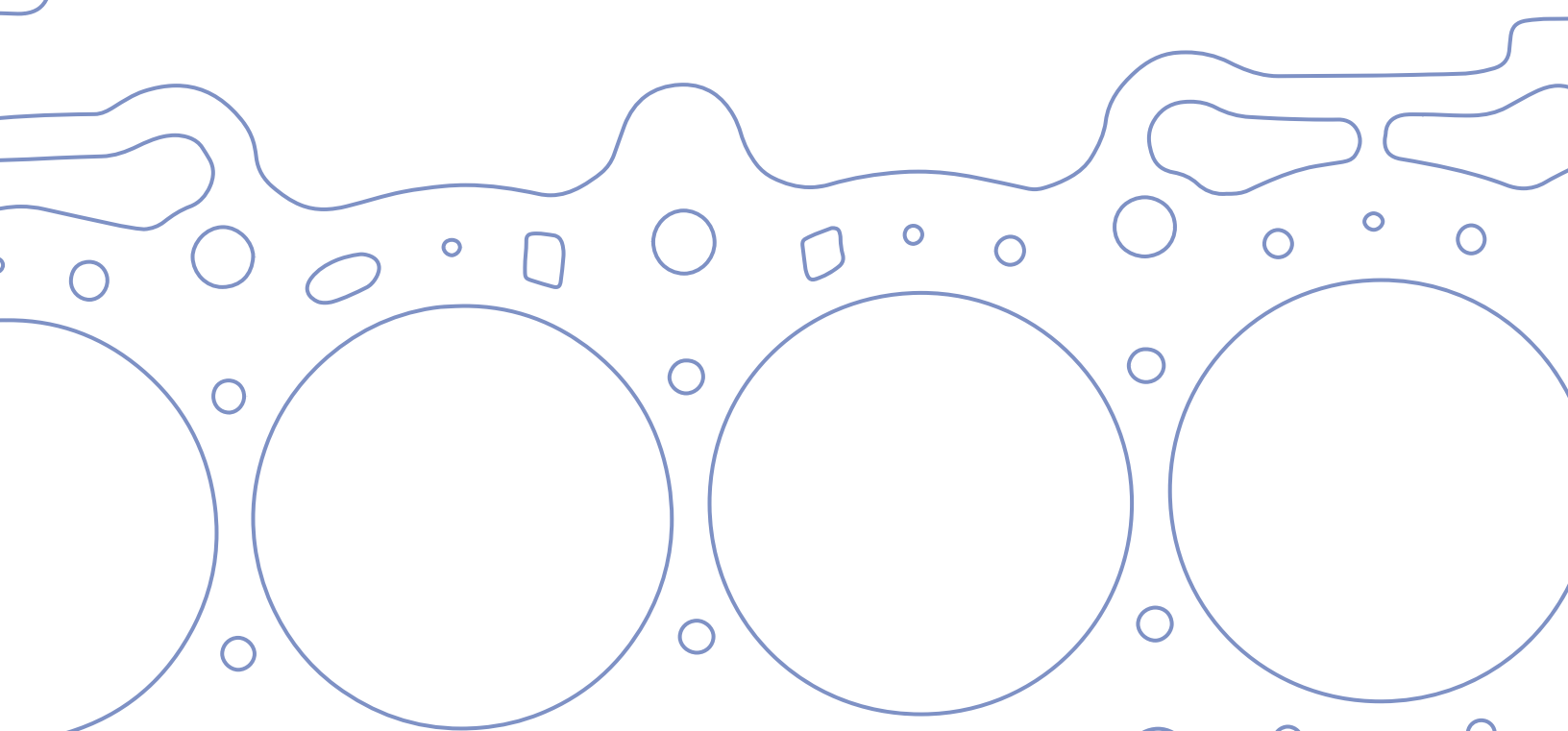





**TOYOTA**

LITROS	MODELO	AÑO	PÁGINA
LITERS	MODEL	YEAR	PAGE
1.5L	TERCEL.	1980/1988	*
1.5L	TERCEL.	1987/1994	*
1.5L	TERCEL, PASEO.	1992/1995	*
1.5L	TERCEL, PASEO.	1995/1999	*
1.6L	COROLLA, CARINA.	1977/1979	<b>183</b>
1.6L	COROLLA, CELICA, GEO PRIZM.	1988/1993	*
1.6L	COROLLA, PRIZM.	1993/1997	*
1.8L	CELICA, COROLLA, MR2, MATRIX, PONTIAC VIBE, PRIZM.	1998/2009	*
1.8L	COROLLA, CELICA, GEO PRIZM.	1993/1997	*
2.0L	CELICA, CAMRY.	1983/1986	*
2.0L	VAN CARGA.	1984/1985	*
2.0L	CAMRY, CELICA, MR2.	1987/1991	<b>183</b>
2.0L	RAV4.	2001/2003	<b>184</b>
2.2L	CELICA, CORONA PICK-UP.	1975/1980	<b>184</b>
2.2L	MR2 TURBO.	1991	*
2.2L	VAN CARGA / PASAJEROS.	1986/1989	<b>185</b>
2.2L	CAMRY, CELICA, MR2.	1991/1995	<b>185</b>
2.4L	PICK-UP, CORONA, CELICA.	1981/1982	<b>186</b>
2.4L	PICK UP, CELICA, 4RUNNER.	1983/1984	<b>186</b>
2.4L	PICK UP, CELICA, 4RUNNER.	1985/1995	<b>187</b>
2.4L	PREVIA.	1991/1997	*
2.4L	RAV4, CAMRY, HIGHLANDER.	2002/2007	*
2.4L	TACOMA.	1994/2004	*
2.7L	TACOMA, T-100, 4RUNNER.	1994/2004	*
2.7L	HIACE, HILUX, VENZA,	2005/2010	<b>187</b>
3.0L	4RUNNER, PICK-UP, T100.	1988/1995	<b>188</b>
3.0L	SUPRA, LEXUS SC300, IS300, GS300.	1993/1998	*
3.0L	CAMRY, LEXUS ES300.	1992/1993	*
3.0L	CAMRY, AVALON, SIENNA, SOLARA.	1994/2000	*
3.4L	TACOMA, 4RUNNER, T-100, TUNDRA.	1995/2004	<b>188</b>
4.0L	LEXUS LS400, SC400.	1990/1997	*
4.0L	LEXUS GS400, LS400, SC400.	1998/2000	*
4.0L	LAND CRUISER.	1988/1992	*
4.2L	LAND CRUISER.	1985/1987	*
4.7L	HINO SERIE 500.	2009/2014	<b>189</b>















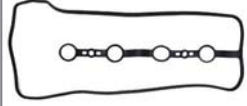

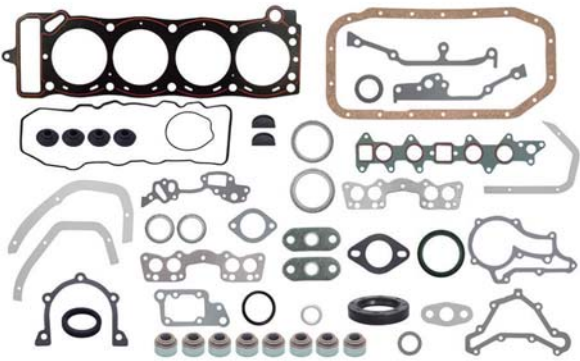

1.6L	MOTOR	MODELOS	DESDE / A	JUNTA DE CABEZA	MULTIPLE DE ADMISIÓN O PLENO
ENGINE	MODELS	FROM / TO	HEAD GASKET	INTAKE	
4L OHV 8V.	COROLLA, CARINA.	1977/1979	CA-1301-B 	MS-41301 	
FS-1301 			MULTIPLE DE ESCAPE EXHAUST	PUNTERIAS VALVE COVER	CARTER OIL PAN
TC-61301 			N/A	VS-31301 	OS-11301 
DISTRIBUCIÓN TIMING COVER		RETÉN CIGÜEÑAL CRANK SEAL	SELLOS DE VALVULA STEM SEALS	JUNTAS VARIAS MISCELLANEOUS	N/A
TC-61301		BS-71301 	SS-8250-N 	N/A	

2.0L	MOTOR	MODELOS	DESDE / A	JUNTA DE CABEZA	MULTIPLE DE ADMISIÓN O PLENO
ENGINE	MODELS	FROM / TO	HEAD GASKET	INTAKE	
4L DOHC 16V, 3SFE.	CAMRY, CELICA, MR2.	1987/1991	CA-1322-ML 	MS-41322 	
FS-1324 			MULTIPLE DE ESCAPE EXHAUST	PUNTERIAS VALVE COVER	CARTER OIL PAN
TC-61322 			MS-41322-E 	VS-31322-R 	OS-11321 
DISTRIBUCIÓN TIMING COVER		RETÉN CIGÜEÑAL CRANK SEAL	SELLOS DE VALVULA STEM SEALS	JUNTAS VARIAS MISCELLANEOUS	
TC-61322		BS-71321 	SS-8109-S 		



2.0L	MOTOR	MODELOS	DESDE / A	JUNTA DE CABEZA	MÚLTIPLE DE ADMISIÓN O PLENO
ENGINE	MODELS	FROM / TO	HEAD GASKET	INTAKE	
4L DOHC 16V MOTOR1AZ-FE	RAV 4	2001/2003	<p>CA-1325-ML</p> 	<p>MS-41325</p> 	
<p>FS-1325-ML</p> 			<p>MÚLTIPLE DE ESCAPE</p> <p>EXHAUST</p> <p>MS-41325-E</p> 	<p>PUNTERIAS</p> <p>VALVE COVER</p> <p>VS-31325-R</p> 	<p>CARTER</p> <p>OIL PAN</p> <p>OS-11325</p> 
<p>DISTRIBUCIÓN</p> <p>TIMING COVER</p>		<p>RETÉN CIGÜEÑAL</p> <p>CRANK SEAL</p> <p>BS-71325</p> 	<p>SELLOS DE VALVULA</p> <p>STEM SEALS</p>	<p>JUNTAS VARIAS</p> <p>MISCELLANEOUS</p> <p>N/A</p>	N/A

2.2L	MOTOR	MODELOS	DESDE / A	JUNTA DE CABEZA	MÚLTIPLE DE ADMISIÓN O PLENO
ENGINE	MODELS	FROM / TO	HEAD GASKET	INTAKE	
4L SOHC 8V 20R	CELICA, CORONA PICK-UP.	1975/1980	<p>CA-1310-G</p> 	<p>MS-41310</p> 	
<p>FS-1310</p> 			<p>MÚLTIPLE DE ESCAPE</p> <p>EXHAUST</p> <p>MS-41310-E</p> 	<p>PUNTERIAS</p> <p>VALVE COVER</p> <p>VS-31310-1R</p> 	<p>CARTER</p> <p>OIL PAN</p> <p>OS-11310</p> 
<p>DISTRIBUCIÓN</p> <p>TIMING COVER</p> <p>TC-61310</p> 		<p>RETÉN CIGÜEÑAL</p> <p>CRANK SEAL</p> <p>BS-71310</p> 	<p>SELLOS DE VALVULA</p> <p>STEM SEALS</p> <p>SS-81310-N</p> 	<p>JUNTAS VARIAS</p> <p>MISCELLANEOUS</p> <p>N/A</p>	N/A





2.2L	MOTOR	MODELOS	DESDE / A	JUNTA DE CABEZA	MULTIPLE DE ADMISIÓN O PLENO
ENGINE	MODELS	FROM / TO	HEAD GASKET	INTAKE	
4L SOHC 8V 4YEC "Y"	VAN CARGA / PASAJEROS.	1986/1989	CA-1326-G	MS-41326	
FS-1326-1G			MULTIPLE DE ESCAPE	PUNTERIAS	CARTER
			EXHAUST	VALVE COVER	OIL PAN
			N/A	VS-31326-R	OS-11301
			N/A		
DISTRIBUCIÓN		RETÉN CIGÜEÑAL	SELLOS DE VALVULA		JUNTAS VARIAS
TIMING COVER		CRANK SEAL	STEM SEALS		MISCELLANEOUS
TC-61323		BS-71304	SS-81310-N		N/A

2.2L	MOTOR	MODELOS	DESDE / A	JUNTA DE CABEZA	MULTIPLE DE ADMISIÓN O PLENO
ENGINE	MODELS	FROM / TO	HEAD GASKET	INTAKE	
4L DOHC 16V 5SFE.	CAMRY, CELICA, MR2.	1991/1995	CA-1322-ML	MS-41322	
FS-1324			MULTIPLE DE ESCAPE	PUNTERIAS	CARTER
			EXHAUST	VALVE COVER	OIL PAN
			MS-41322-E	VS-31322-R	OS-11321
DISTRIBUCIÓN		RETÉN CIGÜEÑAL	SELLOS DE VALVULA		JUNTAS VARIAS
TIMING COVER		CRANK SEAL	STEM SEALS		MISCELLANEOUS
TC-61322		BS-71321	SS-8109-S		



2.4L	MOTOR	MODELOS	DESDE / A	JUNTA DE CABEZA	MULTIPLE DE ADMISIÓN O PLENO
ENGINE	MODELS	FROM / TO	HEAD GASKET	INTAKE	
4L SOHC 8V 22R,22REC	PICK-UP, CORONA, CELICA.	1981/1982	CA-1320-GX	MS-41320	
<b>FS-1320</b> 					
<b>DISTRIBUCIÓN</b>		<b>RETÉN CIGÜEÑAL</b>	<b>SELLOS DE VALVULA</b>	<b>JUNTAS VARIAS</b>	
<b>TIMING COVER</b>		<b>CRANK SEAL</b>	<b>STEM SEALS</b>	<b>MISCELLANEOUS</b>	
TC-61310		BS-71310	SS-81310-N		

2.4L	MOTOR	MODELOS	DESDE / A	JUNTA DE CABEZA	MULTIPLE DE ADMISIÓN O PLENO
ENGINE	MODELS	FROM / TO	HEAD GASKET	INTAKE	
4L SOHC 8V 22R,22REC.	PICK UP, CELICA, 4RUNNER.	1983/1984	CA-1320-GX	MS-41320-1	
<b>FS-1320-1</b> 					
<b>DISTRIBUCIÓN</b>		<b>RETÉN CIGÜEÑAL</b>	<b>SELLOS DE VALVULA</b>	<b>JUNTAS VARIAS</b>	
<b>TIMING COVER</b>		<b>CRANK SEAL</b>	<b>STEM SEALS</b>	<b>MISCELLANEOUS</b>	
TC-61310		BS-71310	SS-81310-N		



2.4L	MOTOR	MODELOS	DESDE / A	JUNTA DE CABEZA	MULTIPLE DE ADMISIÓN O PLENO
ENGINE	MODELS	FROM / TO	HEAD GASKET	INTAKE	
4L SOHC 8V 22R,22REC.	PICK UP, CELICA, 4RUNNER.	1985/1995	CA-1320-GX 	MS-41320-1 	
FS-1320-2 			MULTIPLE DE ESCAPE EXHAUST	PUNTERIAS VALVE COVER	CARTER OIL PAN
			MS-41320-1E 	VS-31310-1R 	OS-11310 
DISTRIBUCIÓN TIMING COVER		RETÉN CIGÜEÑAL CRANK SEAL		SELLOS DE VALVULA STEM SEALS	
TC-61310-1		BS-71310		SS-81310-N 	JUNTAS VARIAS MISCELLANEOUS 

2.7L	MOTOR	MODELOS	DESDE / A	JUNTA DE CABEZA	MULTIPLE DE ADMISIÓN O PLENO
ENGINE	MODELS	FROM / TO	HEAD GASKET	INTAKE	
4L DOHC 16V 1ARFE, 2TRFE.	HIACE, HILUX, VENZA,	2005/2010	CA-1354-ML 		
FS-1354-ML 			MULTIPLE DE ESCAPE EXHAUST	PUNTERIAS VALVE COVER	CARTER OIL PAN
DISTRIBUCIÓN TIMING COVER		RETÉN CIGÜEÑAL CRANK SEAL		SELLOS DE VALVULA STEM SEALS	JUNTAS VARIAS MISCELLANEOUS





3.0L	MOTOR	MODELOS	DESDE / A	JUNTA DE CABEZA	MULTIPLE DE ADMISIÓN O PLENO
ENGINE	MODELS	FROM / TO	HEAD GASKET	INTAKE	
V6 SOHC 12V 3VZE.	4RUNNER, PICK-UP, T100.	1988/1995	CA-1350-G / CA-1351-G	MS-41350	
<b>FS-1350</b> 			PARA VER IMAGEN DIRIGIRSE A SECCIÓN DE JUNTAS DE CABEZA. TO SEE IMAGE GO TO HEAD GASKET SECTION		
<b>DISTRIBUCIÓN</b> TIMING COVER		<b>RETÉN CIGÜEÑAL</b> CRANK SEAL		<b>SELLOS DE VALVULA</b> STEM SEALS	
TC-61350		BS-71350		SS-81350-V	
<b>JUNTAS VARIAS</b> MISCELLANEOUS		<b>MULTIPLE DE ESCAPE</b> EXHAUST		<b>PUNTERIAS</b> VALVE COVER	
N/A		MS-41350-E		VS-31350-R	
		OS-11350			

3.4L	MOTOR	MODELOS	DESDE / A	JUNTA DE CABEZA	MULTIPLE DE ADMISIÓN O PLENO
ENGINE	MODELS	FROM / TO	HEAD GASKET	INTAKE	
V6 DOHC 24V 5VZFE.	TACOMA, 4RUNNER, T-100, TUNDRA.	1995/2004	CA-1357-G / CA-1358-G	MS-41357	
<b>FS-1357</b> 			PARA VER IMAGEN DIRIGIRSE A SECCIÓN DE JUNTAS DE CABEZA. TO SEE IMAGE GO TO HEAD GASKET SECTION		
<b>DISTRIBUCIÓN</b> TIMING COVER		<b>RETÉN CIGÜEÑAL</b> CRANK SEAL		<b>SELLOS DE VALVULA</b> STEM SEALS	
		BS-71350		SS-81357-S	
		OS-11350			
<b>JUNTAS VARIAS</b> MISCELLANEOUS		<b>MULTIPLE DE ESCAPE</b> EXHAUST		<b>PUNTERIAS</b> VALVE COVER	
N/A				VS-31357-R	





4.7L	MOTOR	MODELOS	DESDE / A	JUNTA DE CABEZA		MULTIPLE DE ADMISIÓN O PLENO	
ENGINE		MODELS	FROM / TO	HEAD GASKET		INTAKE	
4L HINO DIESEL 16V J05D-TG.		HINO SERIE 500.	2009/2014				
<b>FS-1382</b>							
				<b>MULTIPLE DE ESCAPE</b> EXHAUST		<b>PUNTERIAS</b> VALVE COVER	<b>CARTER</b> OIL PAN
<b>DISTRIBUCIÓN</b> TIMING COVER		<b>RETÉN CIGÜEÑAL</b> CRANK SEAL		<b>SELLOS DE VALVULA</b> STEM SEALS		<b>JUNTAS VARIAS</b> MISCELLANEOUS	



NOTAS / NOTES:

Lined area for notes with multiple horizontal lines.

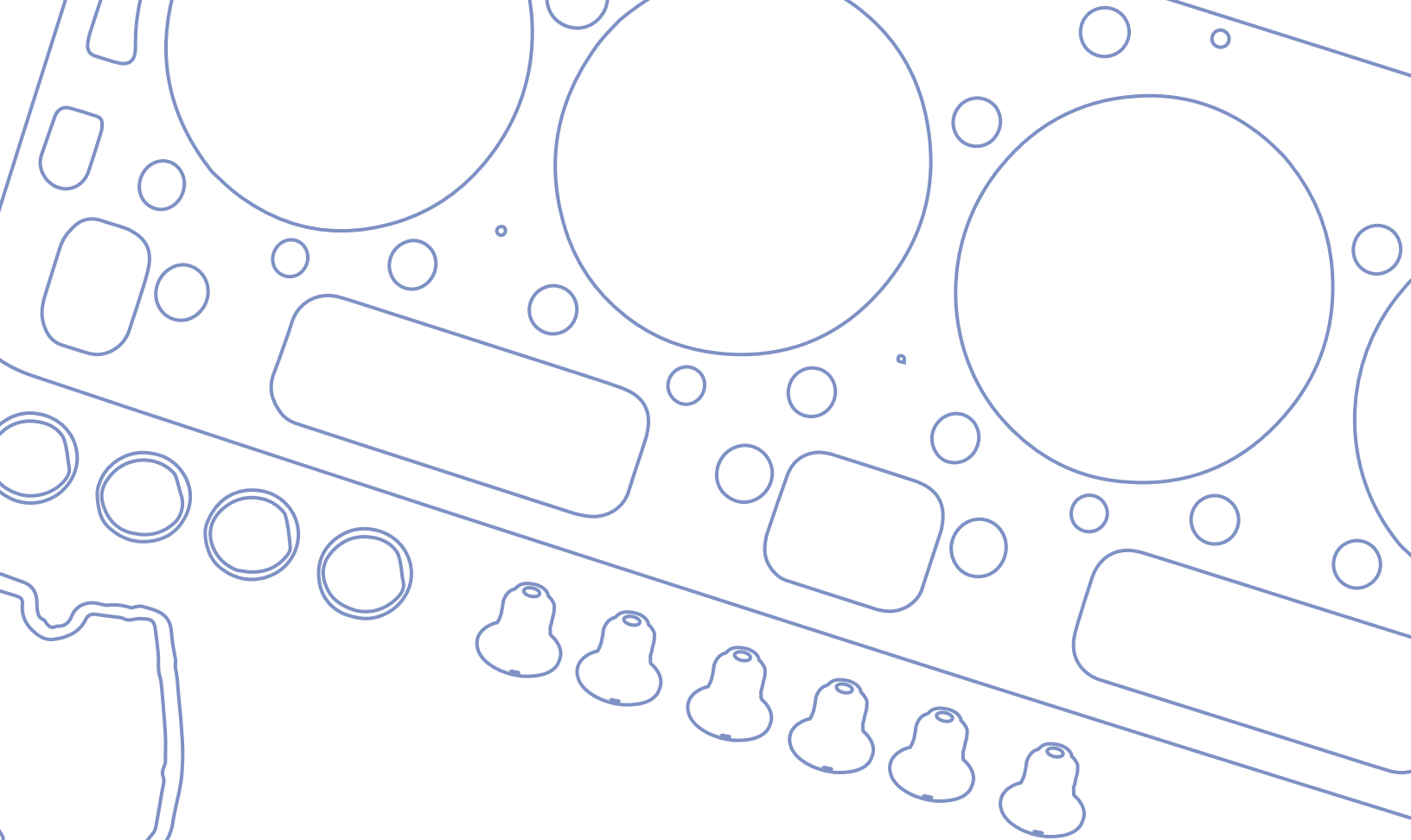

# VOLKSWAGEN

# **VOLKSWAGEN**

MARCA  
/MAKE

CATÁLOGO DE APLICACIONES / APPLICATION CATALOG

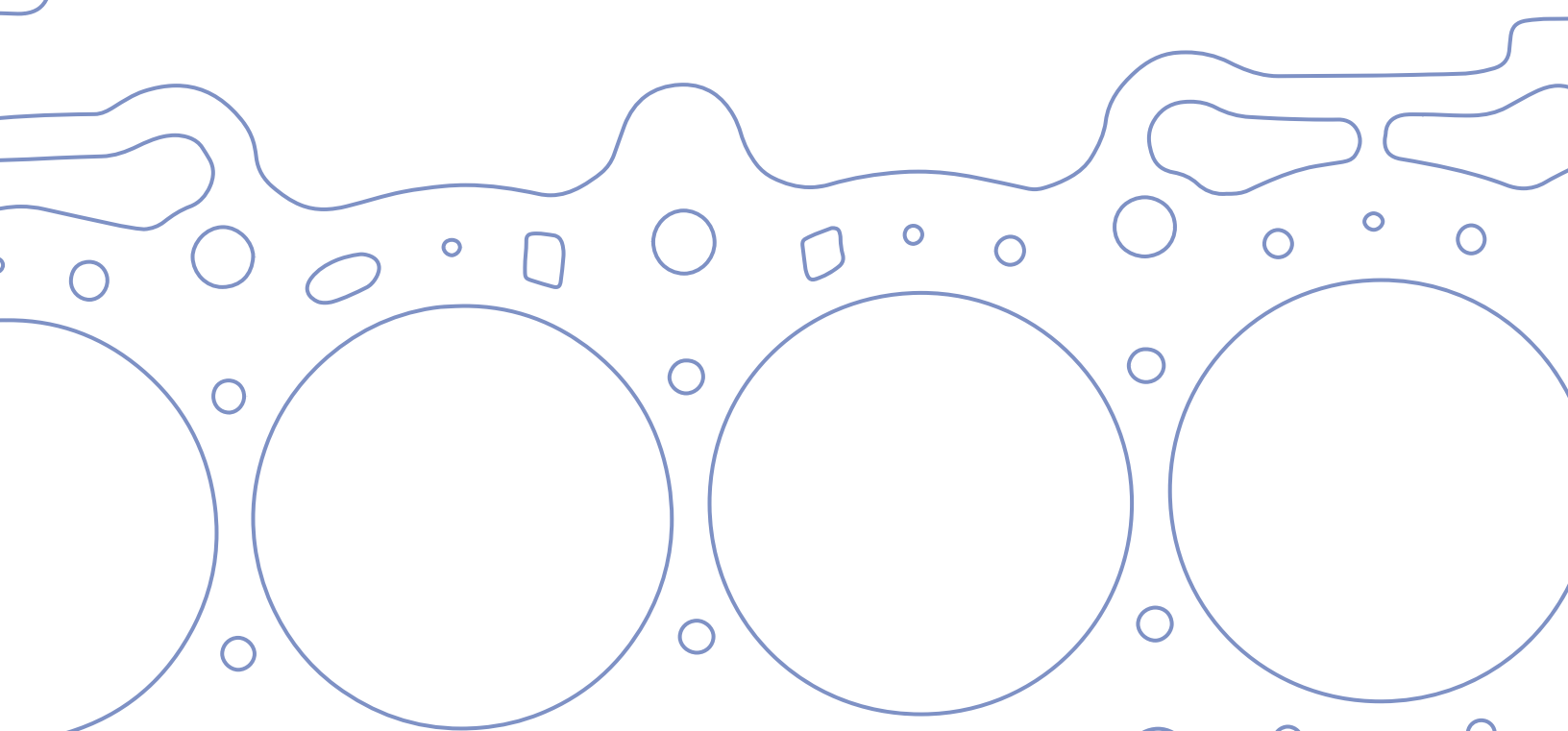





**VOLKSWAGEN**

LITROS	MODELO	AÑO	PÁGINA
LITERS	MODEL	YEAR	PAGE
1.2L	SEDAN	1963/1965	*
1.2L	SEDAN, COMBI	1961/1965	*
1.5L	SEDAN, COMBI	1969/1972	*
1.6L	SEDAN, COMBI	1968/1985	<b>195</b>
1.6L	SEDAN, COMBI, BRASILIA	1986/2003	<b>195</b>
1.6L	VARIANT, ATLANTIC, CARIBE	1977/1986	<b>196</b>
1.6L	LUPO, POLO, CROSSFOX, SPORT VAN, GOL	2003/2014	<b>196</b>
1.7L	ATLANTIC, CARIBE, VARIANT	1977/1986	<b>197</b>
1.7L	CARIBE, ATLANTIC, RABBIT, SCIROCCO	1978/1987	<b>197</b>
1.8L	JETTA A2, GOLF, CORSAR, CABRIOLET, RABBIT	1983/1998	<b>198</b>
1.8L	POINTER, POINTER PICK UP	1998/2002	<b>198</b>
1.8L	PASSAT, BEETLE, SHARAN, JETTA GLI, AUDI A4, A3	2001/2012	<b>199</b>
1.8L	PASSAT, BEETLE, AUDI A4, A3	1995/2000	<b>199</b>
1.8L	PASSAT, AUDI A4, GOLF, BEETLE,	1996/2005	*
1.9L	EUROVAN, TRANSPORTER	2006/2009	*
2.0L	JETTA A3, GOLF, CABRIO	1993/1999	<b>200</b>
2.0L	JETTA A3, GOLF, CABRIO (CABEZA EN MLS)	1993/1999	*
2.0L	JETTA A3, GOLF, POINTER GTI	1999/2000	<b>200</b>
2.0L	JETTA A4, GOLF, BEETLE, IBIZA (CABEZA EN GRAFITO)	2000/2007	<b>201</b>
2.0L	JETTA A4, GOLF, BEETLE, IBIZA (CABEZA EN MLS)	2000/2007	<b>201</b>
2.0L	PASSAT, JETTA GLI	2010/2013	*
2.5L	EUROVAN	2001/2004	<b>202</b>
2.5L	BORA, BEETLE	2005/2010	<b>202</b>
2.5L	EUROVAN, TRANSPORTER	2001/2004	*
2.8L	PASSAT, AUDI A4 y A6	1997/2001	*
2.8L	JETTA VR6, TRANSPORTER, SHARAN, GOLF GTI	1992/2003	*





1.6L	MOTOR	MODELOS	DESDE / A	JUNTA DE CABEZA	MULTIPLE DE ADMISIÓN O PLENO
ENGINE	MODELS	FROM / TO	HEAD GASKET	INTAKE	
H4 8V BOXER	SEDAN, COMBI	1968/1985			MS-41812
<b>FS-1820</b>					
<b>MULTIPLE DE ESCAPE</b>		<b>PUNTERIAS</b>		<b>CARTER</b>	
<b>EXHAUST</b>		<b>VALVE COVER</b>		<b>OIL PAN</b>	
MS-41810		VS-31810		OS-11810	
<b>DISTRIBUCIÓN</b>		<b>RETÉN CIGÜEÑAL</b>		<b>SELLOS DE VALVULA</b>	
<b>TIMING COVER</b>		<b>CRANK SEAL</b>		<b>STEM SEALS</b>	
RE-16077		BS-71800			<b>JUNTAS VARIAS</b>
					<b>MISCELLANEOUS</b>

1.6L	MOTOR	MODELOS	DESDE / A	JUNTA DE CABEZA	MULTIPLE DE ADMISIÓN O PLENO
ENGINE	MODELS	FROM / TO	HEAD GASKET	INTAKE	
H4 8V BOXER	SEDAN, COMBI, BRASILIA	1986/2003			MS-41812
<b>FS-1820-1</b>					
<b>MULTIPLE DE ESCAPE</b>		<b>PUNTERIAS</b>		<b>CARTER</b>	
<b>EXHAUST</b>		<b>VALVE COVER</b>		<b>OIL PAN</b>	
MS-41810		VS-31810		OS-11810	
<b>DISTRIBUCIÓN</b>		<b>RETÉN CIGÜEÑAL</b>		<b>SELLOS DE VALVULA</b>	
<b>TIMING COVER</b>		<b>CRANK SEAL</b>		<b>STEM SEALS</b>	
RE-16077		BS-71800			<b>JUNTAS VARIAS</b>
					<b>MISCELLANEOUS</b>



1.6L	MOTOR	MODELOS	DESDE / A	JUNTA DE CABEZA		MÚLTIPLE DE ADMISIÓN O PLENO
ENGINE	MODELS	FROM / TO	HEAD GASKET		INTAKE	
4L SOHC 8V CARB	VARIANT, ATLANTIC, CARIBE	1977/1986	CA-1830-G		MS-41830-A	
FS-1830-1						
			MÚLTIPLE DE ESCAPE	PUNTERIAS	CARTER	
			EXHAUST	VALVE COVER	OIL PAN	
			MS-41830-E	VS-31830	OS-11830	
DISTRIBUCIÓN		RETÉN CIGÜEÑAL	SELLOS DE VALVULA		JUNTAS VARIAS	
TIMING COVER		CRANK SEAL	STEM SEALS		MISCELLANEOUS	
TC-61830-2		BS-71830	SS-81830			

1.6L	MOTOR	MODELOS	DESDE / A	JUNTA DE CABEZA		MÚLTIPLE DE ADMISIÓN O PLENO
ENGINE	MODELS	FROM / TO	HEAD GASKET		INTAKE	
4L SOHC 8V	LUPO, POLO, CROSSFOX, SPORT VAN, GOL	2003/2014	CA-1835-G		MS-41835-A	
FS-1835-G						
			MÚLTIPLE DE ESCAPE	PUNTERIAS	CARTER	
			EXHAUST	VALVE COVER	OIL PAN	
			MS-41835-E			
DISTRIBUCIÓN		RETÉN CIGÜEÑAL	SELLOS DE VALVULA		JUNTAS VARIAS	
TIMING COVER		CRANK SEAL	STEM SEALS		MISCELLANEOUS	
TC-61835		BS-71835-AT	SV-81852-V			





1.7L	MOTOR	MODELOS	DESDE / A	JUNTA DE CABEZA	MULTIPLE DE ADMISIÓN O PLENO
ENGINE	MODELS	FROM / TO	HEAD GASKET	INTAKE	
4L SOHC 8V CARB	ATLANTIC, CARIBE, VARIANT	1977/1986	<b>CA-1830-G</b> 	<b>MS-41830-A</b> 	
<b>FS-1830-1</b>					
<b>DISTRIBUCIÓN</b>	<b>RETÉN CIGÜEÑAL</b>	<b>SELLOS DE VALVULA</b>	<b>JUNTAS VARIAS</b>		
<b>TIMING COVER</b>	<b>CRANK SEAL</b>	<b>STEM SEALS</b>	<b>MISCELLANEOUS</b>		
<b>TC-61830-2</b>	<b>BS-71830</b>	<b>SS-81830</b>			

1.7L	MOTOR	MODELOS	DESDE / A	JUNTA DE CABEZA	MULTIPLE DE ADMISIÓN O PLENO
ENGINE	MODELS	FROM / TO	HEAD GASKET	INTAKE	
4L SOHC 8V CARB	CARIBE, ATLANTIC, RABBIT, SCIROCCO	1978/1987	<b>CA-1830-G</b> 	<b>MS-41830-1</b> 	
<b>FS-1830-2</b>					
<b>DISTRIBUCIÓN</b>	<b>RETÉN CIGÜEÑAL</b>	<b>SELLOS DE VALVULA</b>	<b>JUNTAS VARIAS</b>		
<b>TIMING COVER</b>	<b>CRANK SEAL</b>	<b>STEM SEALS</b>	<b>MISCELLANEOUS</b>		
<b>TC-61830-1</b>	<b>BS-71830</b>	<b>SS-81830</b>			



1.8L	MOTOR	MODELOS	DESDE / A
ENGINE		MODELS	FROM / TO
4L SOHC 8V CARB & FI		JETTA A2, GOLF, CORSAR, CABRIO-LET, RABBIT	1983/1998

FS-1840

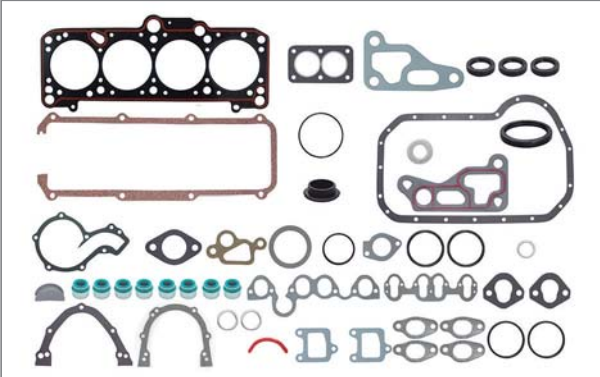

JUNTA DE CABEZA
HEAD GASKET
CA-1840-G

MULTIPLE DE ADMISIÓN O PLENO
INTAKE
MS-041830-A

MULTIPLE DE ESCAPE
EXHAUST
MS-41830-E

PUNTERIAS
VALVE COVER
VS-31830

CARTER
OIL PAN
OS-11830

DISTRIBUCIÓN
TIMING COVER
TC-61830-3



RETÉN CIGÜEÑAL
CRANK SEAL
BS-71830



SELLOS DE VALVULA
STEM SEALS
SS-81830



JUNTAS VARIAS
MISCELLANEOUS

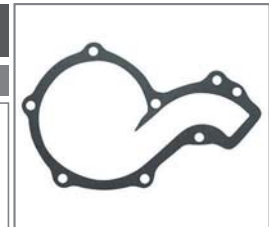

1.8L	MOTOR	MODELOS	DESDE / A
ENGINE		MODELS	FROM / TO
4L SOHC 8V AVH AZG		POINTER, POINTER PICK UP	1998/2002

FS-1840-1

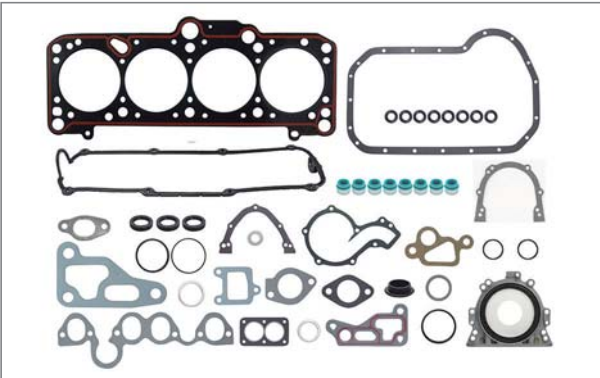

JUNTA DE CABEZA
HEAD GASKET
CA-1840-G

MULTIPLE DE ADMISIÓN O PLENO
INTAKE
MS-41840

MULTIPLE DE ESCAPE
EXHAUST
MS-41830-E

PUNTERIAS
VALVE COVER
VS-31840-R

CARTER
OIL PAN
OS-11830

DISTRIBUCIÓN
TIMING COVER
TC-61830-1



RETÉN CIGÜEÑAL
CRANK SEAL
BS-71840-AT



SELLOS DE VALVULA
STEM SEALS
SS-81830



JUNTAS VARIAS
MISCELLANEOUS





1.8L	MOTOR	MODELOS	DESDE / A	JUNTA DE CABEZA		MULTIPLE DE ADMISIÓN O PLENO
ENGINE	MODELS	FROM / TO	HEAD GASKET		INTAKE	
4L DOHC 20V TURBO ADR ANB AFY	PASSAT, BEETLE, SHARAN, JETTA GLI, AUDI A4, A3	2001/2012	CA-1852-ML		MS-41852-A	
FS-1852						
DISTRIBUCIÓN		RETÉN CIGÜEÑAL	SELLOS DE VALVULA	JUNTAS VARIAS		
TIMING COVER		CRANK SEAL	STEM SEALS	MISCELLANEOUS		
TC-61830-1		BS-71840-AT		SV-81852-V		

1.8L	MOTOR	MODELOS	DESDE / A	JUNTA DE CABEZA		MULTIPLE DE ADMISIÓN O PLENO
ENGINE	MODELS	FROM / TO	HEAD GASKET		INTAKE	
4L DOHC 20V TURBO AEB APH	PASSAT, BEETLE, AUDI A4, A3	1995/2000	CA-1852-1ML		MS-41852-1A	
FS-1852-1						
DISTRIBUCIÓN		RETÉN CIGÜEÑAL	SELLOS DE VALVULA	JUNTAS VARIAS		
TIMING COVER		CRANK SEAL	STEM SEALS	MISCELLANEOUS		
TC-61830-1		BS-71840-AT		SV-81852-V		





2.0L	MOTOR	MODELOS	DESDE / A	JUNTA DE CABEZA	MULTIPLE DE ADMISIÓN O PLENO
ENGINE	MODELS	FROM / TO	HEAD GASKET	INTAKE	
4L SOHC 8V ABA	JETTA A3, GOLF, CABRIO	1993/1999	CA-1845-G	MS-41845	
FS-1845			MULTIPLE DE ESCAPE	PUNTERIAS	CARTER
			EXHAUST	VALVE COVER	OIL PAN
			MS-41845-E	VS-31830	OS-11830
DISTRIBUCIÓN		RETÉN CIGÜEÑAL	SELLOS DE VALVULA	JUNTAS VARIAS	
TIMING COVER		CRANK SEAL	STEM SEALS	MISCELLANEOUS	
TC-61830-3		BS-071845-AT	SS-81845		

2.0L	MOTOR	MODELOS	DESDE / A	JUNTA DE CABEZA	MULTIPLE DE ADMISIÓN O PLENO
ENGINE	MODELS	FROM / TO	HEAD GASKET	INTAKE	
4L SOHC 8V	JETTA A3, GOLF, POINTER GTI	1999/2000	CA-1845-G	MS-41845	
FS-1845-1			MULTIPLE DE ESCAPE	PUNTERIAS	CARTER
			EXHAUST	VALVE COVER	OIL PAN
			MS-41845-E	VS-31840-R	OS-11830
DISTRIBUCIÓN		RETÉN CIGÜEÑAL	SELLOS DE VALVULA	JUNTAS VARIAS	
TIMING COVER		CRANK SEAL	STEM SEALS	MISCELLANEOUS	
TC-61830-3		BS-71845-AT	SS-81845		





2.0L	MOTOR	MODELOS	DESDE / A	JUNTA DE CABEZA	MULTIPLE DE ADMISIÓN O PLENO
ENGINE	MODELS	FROM / TO	HEAD GASKET	INTAKE	
4L SOHC 8V AEG AVH AZG	JETTA A4, GOLF, BEETLE, IBIZA (CABEZA EN GRAFITO)	2000/2007	CA-1850-G	MS-41850	
FS-1850-G			MULTIPLE DE ESCAPE	PUNTERIAS	CARTER
			EXHAUST	VALVE COVER	OIL PAN
			MS-41845-E	VS-31850-R	OS-11850
DISTRIBUCIÓN	RETÉN CIGÜEÑAL	SELLOS DE VALVULA	JUNTAS VARIAS		
TIMING COVER	CRANK SEAL	STEM SEALS	MISCELLANEOUS		
TC-61850	BS-71840-AT	SV-81845-V			

2.0L	MOTOR	MODELOS	DESDE / A	JUNTA DE CABEZA	MULTIPLE DE ADMISIÓN O PLENO
ENGINE	MODELS	FROM / TO	HEAD GASKET	INTAKE	
4L SOHC 8V AEG AVH AZG	JETTA A4, GOLF, BEETLE, IBIZA (CABEZA EN MLS)	2000/2007	CA-1850-ML	MS-41850-R	
FS-1850-ML			MULTIPLE DE ESCAPE	PUNTERIAS	CARTER
			EXHAUST	VALVE COVER	OIL PAN
			MS-41845-E	VS-31850-R	OS-11850
DISTRIBUCIÓN	RETÉN CIGÜEÑAL	SELLOS DE VALVULA	JUNTAS VARIAS		
TIMING COVER	CRANK SEAL	STEM SEALS	MISCELLANEOUS		
TC-61850	BS-71840-AT	SV-81845-V			



2.5L	MOTOR	MODELOS	DESDE / A
ENGINE		MODELS	FROM / TO
5L, SOHC 20V		EUROVAN	2001/2004

**FS-1851**

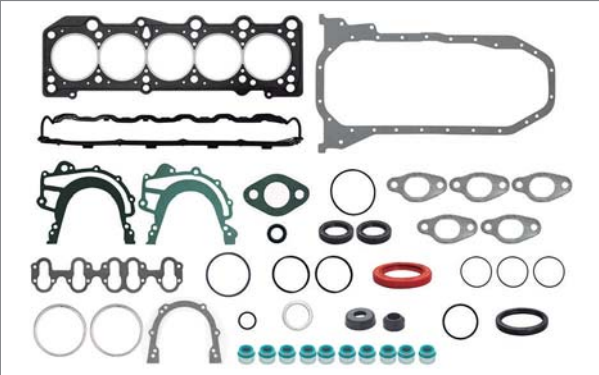

JUNTA DE CABEZA
HEAD GASKET
CA-1851-B

MÚLTIPLE DE ADMISIÓN O PLENO
INTAKE
MS-41851

MÚLTIPLE DE ESCAPE
EXHAUST
MS-41851-E

PUNTERIAS
VALVE COVER
VS-31851-R

CARTER
OIL PAN
OS-11851

DISTRIBUCIÓN
TIMING COVER
TC-61850



RETÉN CIGÜEÑAL
CRANK SEAL
BS-71830



SELLOS DE VALVULA
STEM SEALS
SS-81830



JUNTAS VARIAS
MISCELLANEOUS

2.5L	MOTOR	MODELOS	DESDE / A
ENGINE		MODELS	FROM / TO
5L DOHC 20V CBTA CBUA BGP		BORA, BEETLE	2005/2010

**FS-1856-ML**

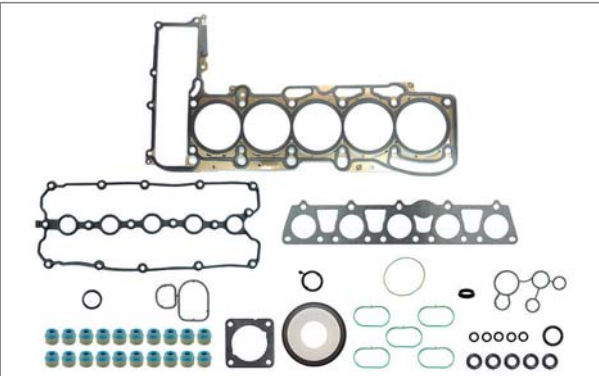

JUNTA DE CABEZA
HEAD GASKET
CA-1856-ML

MÚLTIPLE DE ADMISIÓN O PLENO
INTAKE
MS-41856-A

MÚLTIPLE DE ESCAPE
EXHAUST
MS-41856-E

PUNTERIAS
VALVE COVER
VS-31856-R

CARTER
OIL PAN

DISTRIBUCIÓN
TIMING COVER
TC-61856



RETÉN CIGÜEÑAL
CRANK SEAL
BS-71856-PT



SELLOS DE VALVULA
STEM SEALS
SS-81856-V



JUNTAS VARIAS
MISCELLANEOUS

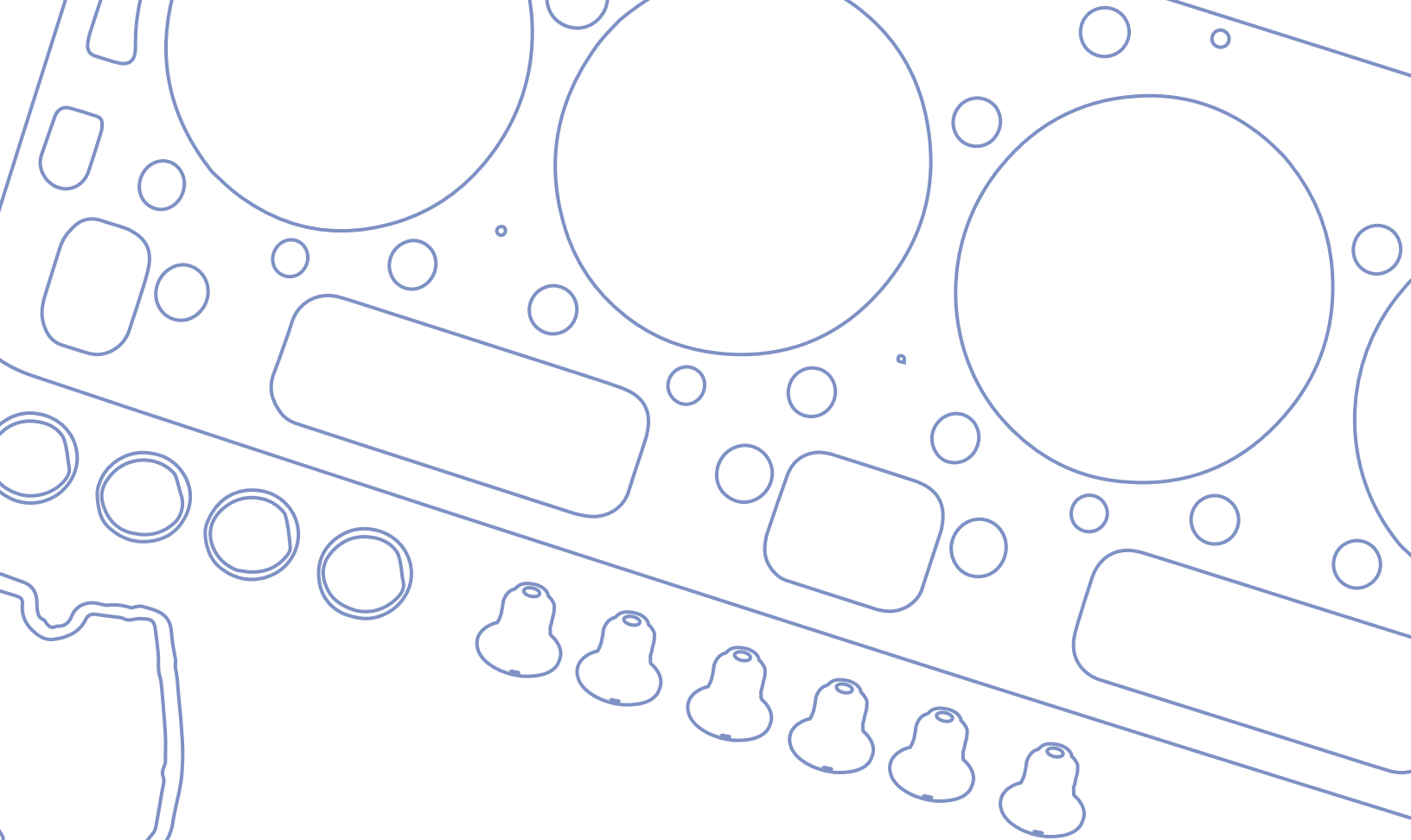

— ■ **JUNTAS DE CABEZA**  
**/ HEAD GASKETS**

**SECCIÓN**  
**/SECTION**

CATÁLOGO DE APLICACIONES / APPLICATION CATALOG

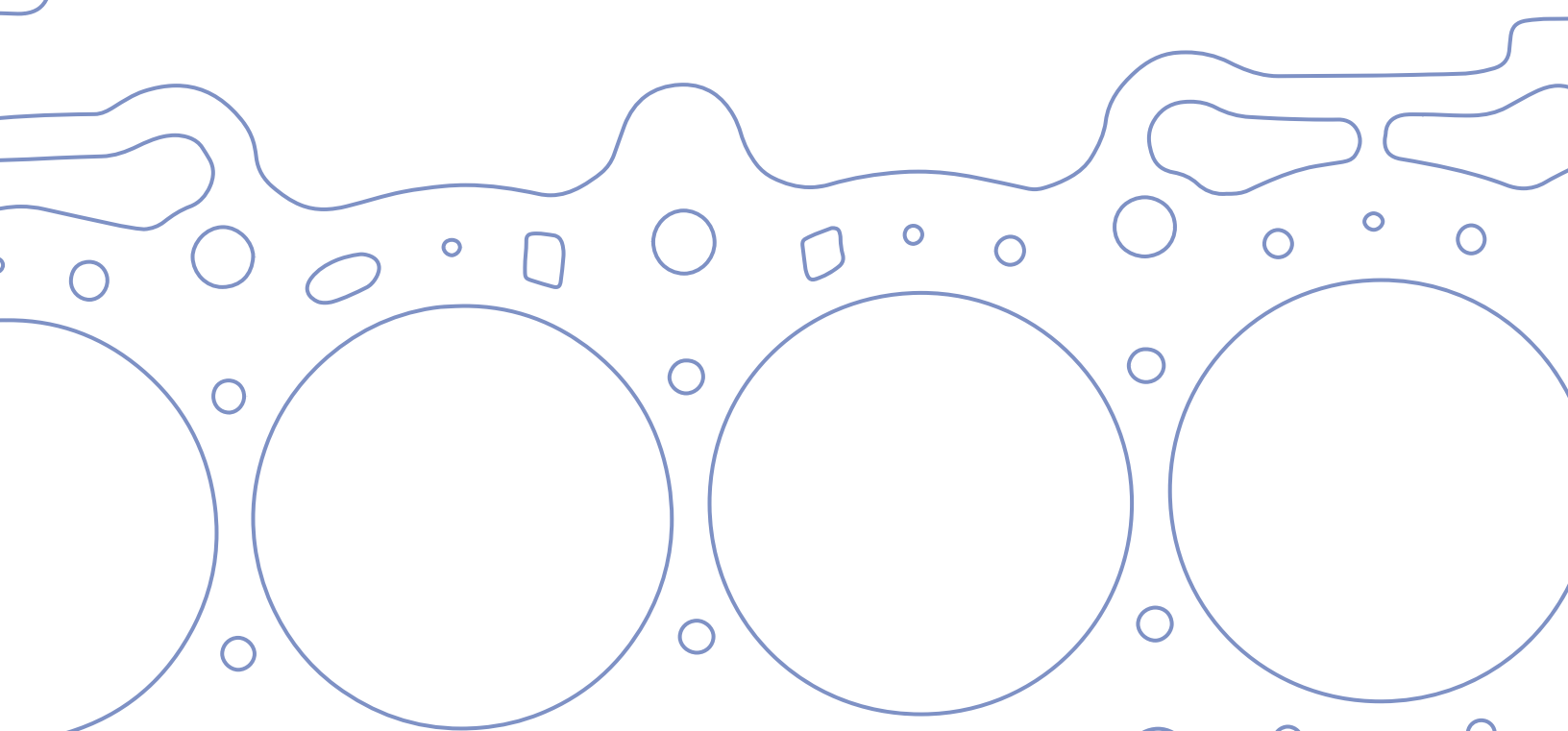





MARCA	LITROS	Numero DC	MODELO	AÑO	PÁGINA
MAKE	LITERS	DC Number	MODEL	YEAR	PAGE
<b>AMC/JEEP</b>	2.5L	CA-703-G	EAGLE, WAGONEER, CHEROKEE, WRANGLER.	1983/1984	215
	3.2L	CA-710-G	EAGLE, RAMBLER AMERICAN, PACER, AMBASSADOR, JAVELIN.	1965/1983	215
	3.8L	CA-710-G	EAGLE, RAMBLER AMERICAN, PACER, AMBASSADOR, JAVELIN.	1965/1983	215
	4.0L	CA-715-G	EAGLE, CHEROKEE, WAGONEER, COMANCHE.	1987/1990	215
	4.2L	CA-710-G	EAGLE, RAMBLER AMERICAN, PACER, AMBASSADOR, JAVELIN.	1965/1983	215
	4.2L	CA-710-G	EAGLE, RAMBLER AMERICAN, PACER, AMBASSADOR, JAVELIN.	1965/1983	215
	4.6L	CA-710-G	EAGLE, RAMBLER AMERICAN, PACER, WAGONEER, JAVELIN.	1965/1987	215
<b>CHRYSLER</b>	1.0L	CA-201-G	ATOS.	2000/2003	216
	1.1L	CA-201-1G	ATOS.	2004/2009	216
	1.4L	CA-204-ML	ATTITUDE.	2006/2011	216
	1.4L	CA-230-G	COLT, MIRAGE, EXCEL.	1979/1991	216
	1.5L	CA-203-ML	VERNA.	2000/2006	216
	1.5L	CA-230-G	COLT, MIRAGE, EXCEL.	1979/1984	216
	1.8L	CA-205-G	EXPO, COLT, MIRAGE	1993/1996	216
	1.8L	CA-237-G	ECLIPSE, TALON, COLT, LASER.	1989/1994	216
	2.0L	CA-235-1G	COLT, VISTA, GALANT, 2000GTX, STELLAR.	1984/1990	217
	2.0L	CA-235-G	COLT, VISTA, GALANT, 2000GTX, STELLAR.	1984/1990	217
	2.0L	CA-242-G	NEON, SEBRING.	1995/1999	217
	2.0L	CA-242-ML	NEON, STRATUS, BREEZE.	1996/2000	217
	2.0L	CA-242-1ML	NEON.	1996/1999	217
	2.2L	CA-240-G	VOYAGER, DART K, SHADOW, SPIRIT, DAYTONA, LeBARON.	1981/1988	217
	2.4L	CA-202-G	H-100.	2003/2005	217
	2.4L	CA-226-G	PATRIOT, JOURNEY, COMPASS, CALIBER, AVENGER (CABEZA EN GRAFITO).	2007/2013	217
	2.4L	CA-226-ML	PATRIOT, JOURNEY, COMPASS, CALIBER, AVENGER (CABEZA EN MLS).	2007/2013	218
	2.4L	CA-243-ML	PT CRUISER.	2001	218
	2.4L	CA-245-G	STRATUS, CIRRUS, VOYAGER, SEBRING.	1995/2000	218
	2.4L	CA-245-1ML	PT CRUISER (CABEZA EN MLS).	2002/2007	218
	2.4L	CA-245-1G	PT CRUISER (CABEZA EN GRAFITO).	2002/2007	218
	2.4L	CA-251-ML	ECLIPSE, GALANT, SEBRING.	2001/2005	218
	2.4L	CA-251-1G	ECLIPSE, GALANT.	1993/1996	218
	2.5L	CA-206-D	H-100.	2005/2009	218
	2.5L	CA-240-G	VOYAGER, DART K, SHADOW, SPIRIT, DAYTONA, LeBARON.	1981/1988	219
	2.5L	CA-252-ML	STRATUS, CIRRUS, SEBRING (CABEZAS DE MLS).	1995/2000	219
	2.5L	CA-252-G	STRATUS, CIRRUS, SEBRING (CABEZAS DE GRAFITO).	1995/2000	219
2.6L	CA-250-G	CARAVAN, VOYAGER, LeBARON, RAM 50.	1981/1989	219	
2.7L	CA-280-G	INTREPID, CONCORDE, CIRRUS, SEBRING. (IZQUIERDA)	1998/2010	219	
2.7L	CA-281-G	INTREPID, CONCORDE, CIRRUS, SEBRING. (DERECHA)	1998/2010	219	
2.7L	CA-280-ML	INTREPID, CONCORDE. (IZQUIERDA)	1998/2000	219	
2.7L	CA-281-ML	INTREPID, CONCORDE. (DERECHA)	1998/2000	219	
3.0L	CA-253-G	CARAVAN, VOYAGER, LeBARON, DYNASTY.	1987/1995	220	
3.2L	CA-225-G	AUTOS Y CAMIONES.	1960/1991	220	
3.2L	CA-266-ML	INTREPID, CONCORDE. (IZQUIERDA)	1998/2001	220	
3.2L	CA-266-1ML	INTREPID, CONCORDE. (DERECHA)	1998/2001	220	
3.3L	CA-254-G	GRAND CARAVAN, GRAND VOYAGER. (IZQUIERDA)	1990/2000	220	
3.3L	CA-255-G	GRAND CARAVAN, GRAND VOYAGER. (DERECHA)	1990/2000	220	
3.3L	CA-255-ML	TOWN & COUNTRY, CARAVAN, VOYAGER. (DERECHA)	2001/2010	220	
3.3L	CA-254-ML	TOWN & COUNTRY, CARAVAN, VOYAGER. (IZQUIERDA)	2001/2010	220	
3.5L	CA-262-ML	CONCORDE, INTREPID (CABEZAS DE MLS). (DERECHA)	1993/1997	221	

MARCA	LITROS	Numero DC	MODELO	AÑO	PÁGINA
MAKE	LITERS	DC Number	MODEL	YEAR	PAGE
CHRYSLER	3.5L	CA-261-ML	CONCORDE, INTREPID (CABEZAS DE MLS). (IZQUIERDA)	1993/1997	221
	3.5L	CA-261-G	INTREPID, CONCORDE, NEW YORKER. (IZQUIERDA)	1993/1997	221
	3.5L	CA-262-G	INTREPID, CONCORDE, NEW YORKER. (DERECHA)	1993/1997	221
	3.5L	CA-268-ML	JOURNEY, AVENGER, SEBRING, CHARGER, CHALLENGER. (IZQUIERDA)	2007/2010	221
	3.5L	CA-268-1ML	JOURNEY, AVENGER, SEBRING, CHARGER, CHALLENGER.(DERECHA)	2007/2010	221
	3.6L	CA-269-1ML	TOWN & COUNTRY, CARAVAN, AVENGER, JOURNEY, CHALLENGER, RAM 1500, 200. (IZQUIERDA)	2011/2013	221
	3.6L	CA-269-ML	TOWN & COUNTRY, CARAVAN, AVENGER, JOURNEY, CHALLENGER, RAM 1500, 200. (DERECHA)	2011/2013	221
	3.7L	CA-271-ML	DAKOTA, RAM 1500, JEEP LIBERTY (CABEZA EN MLS).	2002/2005	222
	3.7L	CA-271-G	DAKOTA, RAM 1500, JEEP LIBERTY (CABEZA EN GRAFITO).	2002/2005	222
	3.8L	CA-210-S	AUTOS Y CAMIONES.	1949/1960	222
	3.8L	CA-254-1G	TOWN & COUNTRY, GRAND CARAVAN, GRAND VOYAGER (CARTER Y PUNTERIAS DE SILICON). (IZQUIERDA)	1998/2000	222
	3.8L	CA-255-1G	TOWN & COUNTRY, GRAND CARAVAN, PACIFICA. (DERECHA)	2002/2008	222
	3.8L	CA-263-G	TOWN & COUNTRY, CARAVAN, VOYAGER (CARTER Y PUNTERIAS DE CORCHO). (DERECHA).	1998/2001	222
	3.8L	CA-263-ML	TOWN & COUNTRY, CARAVAN, VOYAGER.	2001/2010	222
	3.8L	CA-264-G	TOWN & COUNTRY, CARAVAN, VOYAGER (CARTER Y PUNTERIAS DE CORCHO). (IZQUIERDA).	1998/2001	222
	3.8L	CA-264-ML	GRAND CARAVAN, VOYAGER.	2001/2009	223
	3.9L	CA-265-G	DAKOTA AMERICANAS, B150, B250	1987/1989	223
	3.9L	CA-270-G	DAKOTA, RAM 1500, RAM VAN.	1992/1997	223
	4.1L	CA-200-S	NEWPORT, TOWN & COUNTRY, WINDSOR	1954/1960	223
	4.5L	CA-260-G	VALIANT, DART, CHARGER, BARRACUDA, MONACO, CORONET.	1964/1969	223
	4.7L	CA-272-ML	RAM 1500, 2500, GRAND CHEROKEE, DURANGO, DAKOTA (CABEZA MLS).	1999/2005	223
	4.7L	CA-272-G	RAM 1500, 2500, GRAND CHEROKEE, DURANGO, DAKOTA (CABEZA EN GRAFITO).	1999/2005	223
	5.2L	CA-256-G	CORONET, CHARGER, SERIES D100, D200, D300.	1959/1966	223
	5.2L	CA-260-G	VALIANT, DART, CHARGER, BARRACUDA, MONACO, CORONET.	1964/1969	224
	5.2L	CA-275-G	B150, B250, B350, W150, W250, RAMCHARGER, DAKOTA.	1989/1992	224
	5.6L	CA-718-G	AMBASSADOR, JAVELIN, RAMBLER.	1967/1974	224
	5.7L	CA-273-ML	RAM 1500, 2500, 3500, DURANGO, GRAND CHEROKEE, COMANDER. (IZQUIERDA)	2003/2009	224
	5.7L	CA-273-G	300C, CHALLENGER, CHARGER. (IZQUIERDA)	2005/2012	224
	5.9L	CA-249-ML	RAM 2500,3500 CUMMINS TURBO	2003/2008	224
	5.9L	CA-718-G	AMBASSADOR, JAVELIN, MATADOR, CHEROKEE, WAGONEER, GRAND WAGONNER.	1971/1991	224
6.4L	CA-718-G	AMBASSADOR, JAVELIN, RAMBLER.	1971/1978	224	
6.6L	CA-718-G	AMBASSADOR, JAVELIN, MATADOR, CHEROKEE, WAGONNER.	1971/1983	225	
7.2L	CA-258-G	CHARGER, CORONET, BARRACUDA, CHALLENGER, MONACO, CORO- NET, FURY.	1966/1978	225	
8.0L	CA-282-G	RAM 2500, 3500, VIPER.	1992/2003	225	
FORD	1.3L	CA-302-G	FIESTA.	1997/2001	226
	1.4L	CA-307-ML	FIESTA.	1998/2001	226
	1.4L	CA-307-G	FIESTA.	1998/2000	226
	1.6L	CA-317-G	FIESTA, IKON, Ka, COURIER.	2001/2010	226
	1.8L	CA-303-2ML	ESCORT, TRACER.	1991/1996	226

MARCA	LITROS	Numero DC	MODELO	AÑO	PÁGINA
MAKE	LITERS	DC Number	MODEL	YEAR	PAGE
	1.9L	CA-303-G	MERCURY TRACER, ESCORT.	1981/1999	226
	1.9L	CA-303-2G	ESCORT TRACER.	1991/1996	226
	2.0L	CA-303-1G	ESCORT, TRACER, FOCUS.	1981/2004	226
	2.0L	CA-303-1ML	FOCUS.	2000/2004	227
	2.0L	CA-304-G	MAZDA B2000, COURIER.	1970/1984	227
	2.0L	CA-306-G	RANGER.	1983/1986	227
	2.0L	CA-313-ML	CONTOUR, MYSTIQUE, ESCORT,	1995/1999	227
	2.0L	CA-313-G	CONTOUR, ESCORT, FOCUS, ZX2.	1995/1997	227
	2.0L	CA-348-ML	ECOSPORT, MEXICO.	2005/2009	227
	2.0L	CA-348-G	ECOSPORT, FOCUS.	2001/2010	227
	2.2L	CA-321-ML	TRANSIT VAN.	2008/2012	227
	2.3L	CA-300-G	TEMPO, TOPAZ.	1984/1994	228
	2.3L	CA-305-G	RANGER.	1974/2002	228
	2.3L	CA-346-ML	FUSION, MILAN, MAZDA 3.	2006/2009	228
	2.4L	CA-320-G	FALCON, MAVERICK, CUSTOM ECONOLINE.	1960/1983	228
	2.5L	CA-311-ML	CONTOUR, MYSTIQUE, MAZDA MPV. (DERECHA)	1995/2000	228
	2.5L	CA-312-ML	CONTOUR, MYSTIQUE. (IZQUIERDA)	1995/2000	228
	2.5L	CA-319-ML	PROBE, 626, MILLENIA. (DERECHA)	1993/1997	228
	2.5L	CA-319-ML1	PROBE, 626, MILLENIA. (IZQUIERDA)	1993/1997	228
	2.8L	CA-315-G	AEROSTAR, BRONCO II, RANGER.(IZQUIERDA)	1974/1986	229
	2.8L	CA-316-G	BRONCO II, RANGER. (DERECHA)	1974/1986	229
	2.8L	CA-320-G	FALCON, MAVERICK, CUSTOM ECONOLINE	1960/1972	229
<b>FORD</b>	2.9L	CA-308-G	EXPLORER, RANGER. (IZQUIERDA)	1986/1992	229
	2.9L	CA-309-G	EXPLORER, RANGER. (DERECHA)	1986/1992	229
	3.0L	CA-318-G	RANGER, AEROSTAR, TAURUS.	1986/1990	229
	3.0L	CA-322-G	AEROSTAR, B3000. (IZQUIERDA)	1986/1995	229
	3.0L	CA-323-G	AEROSTAR, B3000. (DERECHA)	1986/1995	229
	3.0L	CA-326-G	ESCAPE, TAURUS, SABLE. (IZQUIERDA)	1999/2004	230
	3.0L	CA-326-ML	TAURUS, SABLE. (IZQUIERDA)	2001/2004	230
	3.0L	CA-327-G	ESCAPE, TAURUS, SABLE. (DERECHA)	2001/2004	230
	3.0L	CA-327-ML	TAURUS, SABLE. (DERECHA)	2001/2004	230
	3.5L	CA-310-G	CUSTOM, WAGON PICK-UP.	1954-1964	230
	3.8L	CA-330-G	FORD FAIRMONT.	1982/1983	230
	3.8L	CA-332-1G	WINDSTAR.	1994/1995	230
	3.8L	CA-332-G	WINDSTAR.	1994/1995	230
	3.8L	CA-341-ML	MUSTANG, WINDSTAR, LOBO F-150. (IZQUIERDA)	1995/2003	231
	3.8L	CA-341-G	WINDSTAR, ECONOLINE. (IZQUIERDA)	1997/1998	231
	3.8L	CA-342-ML	MUSTANG, WINDSTAR, LOBO F-150. (DERECHA)	1995/2003	231
	3.8L	CA-342-G	WINDSTAR, ECONOLINE. (DERECHA)	1997/1998	231
	3.9L	CA-325-G	AUTOS Y CAMIONETAS.	1965/1986	231
	4.0L	CA-335-G	AEROSTAR, EXPLORER, RANGER. (IZQUIERDA)	1990/2000	231
	4.0L	CA-336-G	AEROSTAR, EXPLORER, RANGER. (DERECHA)	1990/2000	231
4.0L	CA-337-G	EXPLORER, RANGER. (IZQUIERDA)	1997/2010	231	
4.0L	CA-338-G	EXPLORER, RANGER.(DERECHA)	1997/2010	232	
4.0L	CA-337-ML	EXPLORER, MONTAINNER.(IZQUIERDA)	1997/2010	232	
4.0L	CA-338-ML	EXPLORER, MONTAINNER.(DERECHA)	1997/2010	232	
4.2L	CA-340-L	AUTOS MERCURY.(IZQUIERDA).	1949/1954	232	
4.2L	CA-340-R	AUTOS MERCURY.(DERECHA).	1949/1954	232	

MARCA	LITROS	Numero DC	MODELO	AÑO	PÁGINA
MAKE	LITERS	DC Number	MODEL	YEAR	PAGE
<b>FORD</b>	4.4L	CA-350-B	AUTOS Y CAMIONES.	1956/1964	232
	4.6L	CA-356-ML	GRAND MARQUIS, F-150, F250, LOBO. (IZQUIERDA)	1991/2007	232
	4.6L	CA-357-ML	GRAND MARQUIS, F-150, F250, LOBO. (DERECHA).	1991/2007	232
	4.6L	CA-357-ML1	AUTOS Y CAMIONES MLS 4 CAPAS, F-150, F250, LOBO.(DERECHA)	1991/2007	233
	4.6L	CA-356-ML1	AUTOS Y CAMIONES MLS 4 CAPAS, F-150, F250, LOBO.(IZQUIERDA)	1991/2007	233
	4.6L	CA-356-G	C.VICTORIA, CONTINENTAL, GRAND MARQUIS.(IZQUIERDA)	1991/1994	233
	4.6L	CA-357-G	GRAND MARQUIS, F-150, F250, LOBO. (DERECHA)	1991/2007	233
	5.0L	CA-360-G	AUTOS Y CAMIONES. (DERECHA)	1962/1997	233
	5.4L	CA-355-G	AUTOS Y CAMIONES.	1961/1976	233
	5.4L	CA-356-ML1	AUTOS Y CAMIONES MLS 4 CAPAS, F-150, F250, LOBO.(IZQUIERDA)	1991/2007	233
	5.4L	CA-357-ML1	AUTOS Y CAMIONES MLS 4 CAPAS, F-150, F250, LOBO.(DERECHA)	1991/2007	233
	5.4L	CA-356-ML	F-250, F-150, LOBO, G, MARQUIS. (IZQUIERDA)	1991/2007	234
	5.4L	CA-357-ML	F-250, F-150, LOBO, G, MARQUIS. (IZQUIERDA)	1991/2007	234
	5.4L	CA-356-G	F-150, F250, LOBO. (DERECHA)	1991/2009	234
	5.4L	CA-357-G	F-150, F250, LOBO. (DERECHA)	1991/2009	234
	5.4L	CA-356-1G	EXPEDITION, LOBO, F-150, F-250 NAVIGATOR. (IZQUIERDA)	2004/2010	234
	5.4L	CA-357-1G	EXPEDITION, LOBO, F-150, F-250 NAVIGATOR. (DERECHA)	2004/2010	234
	5.8L	CA-365-G	TRUCKS, GALAXIE, GRAND MARQUIS.	1969/1983	234
	5.8L	CA-370-G	F-150, PICK-UP, TRUCKS.	1970/1982	234
	6.1L	CA-380-G	CAMIONES.	1979/1989	235
	6.8L	CA-390-ML	TRUCKS, F-450 SUPER DUTY, EXCURSION. (IZQUIERDA)	1997/2003	235
	6.8L	CA-391-ML	ECONOLINE, SUPER DUTY, F-450. (DERECHA)	1997/2003	235
	6.8L	CA-390-G	TRUCKS, F-450 SUPER DUTY. (IZQUIERDA)	1997/1999	235
	6.8L	CA-391-G	F-450,SUPER DUTY. (DERECHA)	1999/2007	235
	7.0L	CA-375-G	GALAXIE, CUSTOM 500, F-350, F-600.	1968/1985	235
	7.3L	CA-376-G	F SUPER DUTY ,F-250-E250-E-350	1988/1995	235
	7.3L	CA-396-1G	E-250, E-350, ECONOLINE.	1994-2003	235
	7.5L	CA-375-G	GALAXIE, CUSTOM 500, F-350, F-700.	1968/1985	236
	<b>GENERAL MOTORS</b>	1.0L	CA-95-G	SPRINT, FIREFLY, FORSA.	1985/1988
1.0L		CA-95-1G	GEO METRO, SWIFT.	1989/1997	237
1.0L		CA-116-G	MATIZ G2.	2004/2010	237
1.2L		CA-119-ML	SPARK.	2011/2013	237
1.4L		CA-100-G	CHEVY POP, JOY, SWING.	1994/2001	237
1.4L		CA-101-G	PONTIAC ACADIAN, T1000, CHEVETTE.	1976/1987	237
1.6L		CA-100-1G	CHEVY MONZA, PICK-UP.	1996/2010	237
1.6L		CA-101-G	PONTIAC ACADIAN, T1000, CHEVETTE.	1976/1987	237
1.6L		CA-102-1G	AVEO, PONTIAC G3 (CABEZA DE GRAFITO).	2008/2012	238
1.6L		CA-102-1ML	AVEO, PONTIAC G3 (CABEZA DE MLS).	2008/2012	238
1.6L		CA-103-G	CHEVY NOVA.	1986/1988	238
1.6L		CA-402-G	TRACKER, SIDEKICK, SWIFT.	1989/2002	238
1.8L		CA-102-G	S10, PICK-UP, BLAZER, TROOPER.	1972/1982	238
1.8L		CA-104-G	CAVALIER, FIRENZA, SKYHAWK, SUNBIRD.	1982	238
1.8L		CA-107-G	SUNBIRD, FIRENZA, J2000.	1982/1986	238
1.8L		CA-114-G	ASTRA, ZAFIRA, (CABEZA DE GRAFITO).	2000/2008	238
1.8L		CA-114-ML	ASTRA HATCHBACK (CABEZA DE MLS).	2000/2008	239
1.8L	CA-118-G	CORSA, PICK-UP TORNADO.	2003/2006	239	
1.8L	CA-122-ML	CRUZE, SONIC. (CABEZA DE MLS).	2011/2013	239	
1.8L	CA-122-G	CRUZE, SONIC. (CABEZA DE GRAFITO).	2011/2013	239	



MARCA	LITROS	Numero DC	MODELO	AÑO	PÁGINA
MAKE	LITERS	DC Number	MODEL	YEAR	PAGE
	1.9L	CA-102-G	S10, PICK-UP, BLAZER, TROOPER.	1982/1985	239
	1.9L	CA-111-G	SATURN.	1991/2002	239
	1.9L	CA-115-G	SATURN SC2, SL2, SC, SL2.	1991/1995	239
	2.0L	CA-104-G	CAVALIER, FIRENZA, SKYHAWK, SUNBIRD.	1983/1987	239
	2.0L	CA-107-G	J2000, SUNBIRD.	1982/1986	240
	2.0L	CA-108-G	CAVALIER USA, PICK-UP S10, BLAZER, BERETTA, CORSICA.	1987/1989	240
	2.0L	CA-117-ML	OPTRA, ASTRA, FORENZA.	2004/2010	240
	2.0L	CA-117-G	ASTRA, OPTRA.	2004/2008	240
	2.0L	CA-133-ML	TRACKER, VITARA (CABEZA DE MLS).	1999/2003	240
	2.2L	CA-108-G	CAVALIER USA, PICK-UP S10, BLAZER, BERETTA, CORSICA.	1990/1991	240
	2.2L	CA-112-G	S-10, BLAZER, SONOMA, ISUZU HOMBRE.	1994/1997	240
	2.2L	CA-113-G	ASTRA, ZAFIRA, SUNFIRE, CAVALIER, HHR (CABEZA DE GRAFITO).	2001/2008	240
	2.2L	CA-113-ML	ASTRA, ZAFIRA, SUNFIRE, CAVALIER, HHR (CABEZA DE MLS).	2001/2008	241
	2.3L	CA-109-G	PONTIAC SUNFIRE, CUTLASS, BERETTA, GRAND AM, GRAND PRIX, CALAIS, SKYLARK.	1987/1991	241
	2.3L	CA-1710-G	AMIGO, TROOPER, IMPULSE, PICK UP. LUV.	1997/1998	241
	2.4L	CA-109-1G	PONTIAC SUNFIRE, GRAND AM, CAVALIER.	1997/2002	241
	2.4L	CA-109-2G	ALERO, CAVALIER, MALIBU, PONTIAC GRAND AM, SUNFIRE.	1999/2002	241
	2.4L	CA-117-ML	PONTIAC G4, ASTRA.	2004/2006	241
	2.5L	CA-105-G	PONTIAC SPIRIT USA, AMX MEXICO, CAMARO, CELEBRITY, CITATION, CJ5, CJ7.	1979/1983	241
<b>GENERAL MOTORS</b>	2.5L	CA-106-G	CENTURY, SKYLARK, GRAND AM.	1985/1986	241
	2.7L	CA-123-G	VITARA, GRAND VITARA.	2006/2010	242
	2.7L	CA-123-1G	VITARA, GRAND VITARA.	2006/2010	242
	2.8L	CA-126-ML	COLORADO CITATION, CELEBRITY, CENTURY, CAMARO, JEEP, EAGLE (USA), PON-	2004/2006.	242
	2.8L	CA-140-G	TIAC FIERO, CAMION.	1980/1995	242
	2.8L	CA-141-G	MPFI 2a GENERACION, CAVALIER, CUTLASS, EUROSPORT, CENTURY.	1988/1994	242
	2.9L	CA-127-ML	COLORADO PICK-UP.	2007/2009	242
	3.1L	CA-141-G	CAVALIER, GRAND AM, CUTLASS.	1988/2001	242
	3.1L	CA-145-G	CUTLASS, BERETTA, MONTE CARLO, LUMINA.	1993/2007	242
	3.3L	CA-146-G	PONTIAC GRAND AM, BUICK CENTURY, OLDSMOBILE CUTLAS CIERA, PONTIAC BONNEVILLE, BUICK LESABRE, REGAL, RIVERA, CHEVROLET LUMINA APV.	1990/1991	243
	3.4L	CA-172-G	MONTE CARLO, OLDSMOBILE CUTLASS SUPREME, PONTIAC GRAND PRIX.	1991/1995	243
	3.4L	CA-173-G	VENTURE, GRAND AM, IMPALA.	1996/2003	243
	3.5L	CA-110-S	BEL AIR, FLEETMASTER, TWO-TEN SERIES, AUTOS Y CAMIONES TODOS.	1937/1953	243
	3.5L	CA-128-ML	COLORADO, CANYON, H3, i-350.	2004/2006	243
	3.5L	CA-156-G	AURORA, INTRIGUE. (IZQUIERDA)	1999/2002	243
	3.5L	CA-156-1G	AURORA, INTRIGUE. (DERECHA)	1999/2002	243
3.6L	CA-183-ML	ACADIA, EQUINOX, MALIBU, G6, G8, TORRENT, CADILLAC CTS, SRX Y STS.	2004/2011	243	
3.6L	CA-183-1ML	EQUINOX, MALIBU, TORRENT.	2008/2010	244	
3.7L	CA-129-ML	COLORADO, CANYON, ISUZU I-370, HUMMER H3.	2007/2012	244	
3.8L	CA-120-S	BEL AIR, AUTOS & CAMIONES.	1953/1962	244	
3.8L	CA-142-G	AUTOS BUICK, CUTLASS, MONTE CARLO, MALIBU.	1977/1982	244	
3.8L	CA-143-G	MALIBU, IMPALA, CAPRICE, PONTIAC LeMANS.	1980/1984	244	
3.8L	CA-146-G	PONTIAC GRAND AM, BUICK CENTURY, OLDSMOBILE CUTLAS CIERA, PONTIAC BONNEVILLE, BUICK LESABRE, REGAL, RIVERA, CHEVROLET	1991/1993	244	

MARCA	LITROS	Numero DC	MODELO	AÑO	PÁGINA
MAKE	LITERS	DC Number	MODEL	YEAR	PAGE
			LUMINA APV.		
	3.8L	CA-147-G	ELECTRA, LE SABRE, REATTA, RIVERA.	1988/1990	244
	3.8L	CA-148-G	GRAND PRIX, LeSABRE, MONTE CARLO, LUMINA, REGAL, BONNEVILLE. (IZQUIERDA)	1997/2005	244
	3.8L	CA-149-G	BUICK LE SABRE, REGAL, RIVIERA, PONTIAC GRAND PRIX, LUMINA, MONTE CARLO, IMPALA. (DERECHA)	1995/2005	245
	3.8L	CA-149-1G	PARK AVENUE, REGAL, RIVIERA, IMPALA, GRAND PRIX (SUPERCARGADOS).	1997/2005	245
	4.0L	CA-139-1G	AURORA, OLDSMOBILE ;SHELBY. (DERECHA)	1995/2003	245
	4.0L	CA-139-G	AURORA, OLDSMOBILE ;SHELBY. (IZQUIERDA)	1995/2003	245
	4.1L	CA-130-G	AUTOS Y CAMIONES.	1963/1992	245
	4.1L	CA-132-G	SERIES C10, C20, C30, K10, K20.	1979	245
	4.2L	CA-153-ML	TRAILBLAZER, ENVOY, ASCENDER, BRAVADA (CABEZA DE MLS).	2002/2006	245
	4.2L	CA-153-G	TRAILBLAZER, ENVOY, ASCENDER, BRAVADA (CABEZA DE GRAFITO).	2002/2006	245
	4.3L	CA-125-B	PICK-UP K10, K20, CAMION.	1954/1962	246
	4.3L	CA-144-G	ASTRO, PICKUP S-10, C10, C20, C1500, C2500, SAFARI, CAPRICE, EL CAMINO.	1985/1990	246
	4.3L	CA-151-G	CAPRICE.	1994/1996	246
	4.3L	CA-162-G	CUTLASS, BROGHAM, CALAIS, CRUSIER, SALON, DELTA 88, OMEGA.	1977/1982	246
	4.6L	CA-174-G	CADILLAC DEVILLE, ELDORADO, SEVILLE , PONTIAC BONEVILLE. (DERECHA)	2000/2001	246
<b>GENERAL MOTORS</b>	4.6L	CA-174-1G	CADILLAC DEVILLE, ELDORADO, SEVILLE , PONTIAC BONEVILLE. (IZQUIERDA)	2000/2001 1963/1992	246 246
	4.8L	CA-130-G	AUTOS Y CAMIONES.	1999/2001	246
	4.8L	CA-175-G	CHEYENNE, SILVERADO 1500, 2500, SUBURBAN, YUKON, SIERRA 1500, 2500, TAHOE (CABEZAS DE GRAFITO).	1999/2001	247
	4.8L	CA-175-ML	CHEYENNE, SILVERADO 1500, 2500, SUBURBAN, YUKON, SIERRA 1500, 2500, TAHOE (CABEZAS DE MLS).	1977/1981	247
	4.9L	CA-170-B	BUICK, ELECTRA, LESABRE, SKYLARK, PONTIAC LEMANS, VENTURA.	1976/1980	247
	5.0L	CA-160-G	AUTOS Y CAMIONES.		
	5.0L	CA-163-T	BUICK, CADILLAC, CHEVROLET, OLDSMOBILE.	1980/1984	247
	5.3L	CA-175-ML	CHEYENNE, SILVERADO 1500, 2500, SUBURBAN, YUKON, SIERRA 1500, 2500, TAHOE (CABEZAS DE MLS).	1999/2001	247
	5.3L	CA-175-G	CHEYENNE, SILVERADO 1500, 2500, SUBURBAN, YUKON, SIERRA 1500, 2500, TAHOE (CABEZAS DE GRAFITO).	1999/2001	247
	5.7L	CA-150-G	MICROBUS, SUBURBAN, C-2500, C-3500, PICK-UP SOLO MEXICO.	1992/1998	247
5.7L	CA-151-1G	FIREBIRD, CAMARO Z28, CAPRICE.	1992/1997	247	
5.7L	CA-164-G	APOLLO, OMEGA, CENTURY, ELECTRA, LE SABRE, OLDSMOBILE, BUICK.	1968/1980	248	
5.7L	CA-165-T	CADILLAC SEVILLE.	1976	248	
6.0L	CA-176-G	SILVERADO 2500, SIERRA 2500, YUKON, EXPRESS VAN,CARGO VAN, SUBURBAN (CABEZA DE GRAFITO).	1999/2000	248	
6.0L	CA-176-ML	SILVERADO 2500, SIERRA 2500, YUKON, EXPRESS VAN,CARGO VAN, SUBURBAN (CABEZAS DE MLS).	1999/2000	248	
6.2L	CA-179-G	SUBURBAN 1500, 2500, 3500, PICK UP K1500, 2500, 3500, C1500, C2500, C3500, HUMMER.	1982/1993	248	
6.5L	CA-180-GD	PICK UP C1500, C2500, C3500, K1500, K2500, K3500, EXPRESS 2500, 3500, SAVANA, YUKON, TAHOE, HUMMER H1.	1994/2005	248	
6.6L	CA-155-G	MONTE CARLO, IMPALA, CHEVELLE NOMAD, CAPRICE, BEL AIR, CAMARO, EL CAMINO, PONTIAC FIREBIRD, BONNEVILLE.	1970/1976	248	

MARCA	LITROS	Numero DC	MODELO	AÑO	PÁGINA	
MAKE	LITERS	DC Number	MODEL	YEAR	PAGE	
<b>GENERAL MOTORS</b>	7.0L	CA-167-G	CAMARO, CORVETTE, CAPRICE, IMPALA.	1965/1969	248	
	7.4L	CA-167-G	AUTOS Y CAMIONES.	1970/1980	249	
	7.4L	CA-168-G	PICK UP C1500, C2500, C3500.	1980/1985	249	
	7.4L	CA-169-G	KODIAK C2500, C3500, K2500, K3500.	1996/2000	249	
	7.5L	CA-165-T	OLDSMOBILE DELTA, CUTLASS, VISTA.	1968/1974	249	
	8.1L	CA-181-G	SILVERADO, 2500HD, 3500, SIERRA 2500, 3500, YUKON, SUBURBAN, AVALANCHE, EXPRESS VAN.	2001/2007	249	
<b>HONDA</b>	1.3L	CA-1450-G	CIVIC.	1984/1987	250	
	1.5L	CA-1450-G	CIVIC.	1984/1991	250	
	1.5L	CA-1452-G	CIVIC (CABEZA DE GRAFITO).	1988/1995	250	
	1.6L	CA-1454-G	CIVIC DEL SOL.	1994/2000	250	
	1.6L	CA-1455-ML	CIVIC, ACURA EL (CABEZA DE MLS).	1996/2000	250	
	1.6L	CA-1455-G	CIVIC. ACURA EL (CABEZA DE GRAFITO).	1996/2000	250	
	1.7L	CA-1459-G	CIVIC, ACURA EL.	2001/2005	250	
	1.7L	CA-1459-ML	CIVIC, ACURA EL.	2001/2005	250	
	1.8L	CA-1454-G	ACURA INTEGRA.	1994/2001	251	
	1.8L	CA-1480-ML	CIVIC EX, DX, LXS.	2006/2009	251	
	2.0L	CA-1453-G	ACCORD, PRELUDE.	1985/1989	251	
	2.0L	CA-1461-ML	CR-V.	1997/2001	251	
	2.2L	CA-1457-ML	ACCORD.	1990/1991	251	
	2.2L	CA-1457-G	ACCORD, PRELUDE.	1990/1997	251	
	2.3L	CA-1463-ML	ACCORD, ODYSSEY, ACURA CL.	1998/2002	251	
	2.3L	CA-1473-ML	PRELUDE.	1992/1996	251	
	2.4L	CA-1466-ML	CR-V.	2002/2006	252	
	2.4L	CA-1469-ML	CR-V, ACCORD, ELEMENT, ACURA TSX.	2004/2010	252	
	2.7L	CA-1465-G	ACCORD.	1995/1997	252	
	3.0L	CA-1467-ML	ACCORD, ACURA CL.	1997/2002	252	
	3.2L	CA-1470-G	ACURA LEGEND, TL.	1991/1998	252	
	3.2L	CA-1471-ML	ACURA CL, TL.	1999/2003	252	
	3.2L	CA-1471-1ML	ACURA TL.	2004/2008	252	
	3.5L	CA-1470-G	ACURA RL. (IZQUIERDA)	1996/2004	252	
	3.5L	CA-1470-1G	ACURA RL. (DERECHA)	1996/2004	253	
	3.5L	CA-1471-ML	ODYSSEY, PILOT, ACURA MDX.	1999/2004	253	
	3.5L	CA-1471-1ML	PILOT, ODYSSEY, RIDGELINE, ACURA MDX, SATURN VUE.	2003/2010	253	
	3.5L	CA-1476-ML	ACCORD, ACCORD CROSSTOUR, PILOT, RIDGELINE, ODYSSEY, ACURA RDX, TSX, TL. (DERECHA)	2008/2013	253	
	3.5L	CA-1476-1ML	ACCORD, ACCORD CROSSTOUR, PILOT, RIDGELINE, ODYSSEY, ACURA RDX, TSX, TL. (IZQUIERDA)	2008/2013	253	
	<b>ISUZU</b>	2.6L	CA-1720-G	RODEO, TROOPER, AMIGO.	1988/1997	254
		3.2L	CA-1750-G	RODEO, TROOPER, HONDA PASSPORT.	1992/1995	254
		3.2L	CA-1752-ML	RODEO, AMIGO, TROOPER, AXIOM, VehiCROSS, HONDA PASSPORT. (IZQUIERDA)	1998/2003	254
3.2L		CA-1752-1ML	RODEO, AMIGO, TROOPER, AXIOM, VehiCROSS, HONDA PASSPORT. (DERECHA)	1998/2003	254	
3.5L		CA-1752-1ML	RODEO, AMIGO, TROOPER, AXIOM, VehiCROSS, HONDA PASSPORT. (DERECHA)	1998/2003	254	
3.5L	CA-1752-ML	RODEO, AMIGO, TROOPER, AXIOM, VehiCROSS, HONDA PASSPORT. (IZQUIERDA)	1998/2003	254		

MARCA	LITROS	Numero DC	MODELO	AÑO	PÁGINA
MAKE	LITERS	DC Number	MODEL	YEAR	PAGE
<b>MAZDA</b>	1.6L	CA-324-ML	MAZDA 3.	2006/2007	255
	1.6L	CA-1107-G	MIATA, CAPRI, 323, MX-5.	1988/1994	255
	1.8L	CA-1111-2ML	MIATA.	2001/2005	255
	2.0L	CA-1110-G	PICK UP B2000, 626.	1983/1987	255
	2.0L	CA-1112-ML	626, PROTEGE, PROBE, MX-6.	1993/1997	255
	2.2L	CA-1120-G	626, MX-6, FORD PROBE.	1988/1992	255
	2.5L	CA-328-1ML	COUGAR, MAZDA MPV. (IZQUIERDA)	2001/2002	255
	2.5L	CA-328-ML	COUGAR, MAZDA MPV. (DERECHA)	2001/2002	255
	2.6L	CA-1125-G	PICK-UP B2600, MPV.	1989/1994	256
	3.0L	CA-1130-ML	929, MPV. (DERECHO)	1989/1998	256
	3.0L	CA-1131-ML	929, MPV. (IZQUIERDO).	1989/1998	256
	1.2L	CA-1213-G	AUTOS AMERICANOS.	1980/1982	257
	1.4L	CA-1213-G	AUTOS AMERICANOS.	1979/1982	257
	1.5L	CA-1213-G	AUTOS AMERICANOS.	1979/1982	257
	1.5L	CA-1216-G	TSURU I.	1984/1987	257
	1.6L	CA-1216-G	TSURU II.	1987/1991	257
1.6L	CA-1226-G	200S SX, SENTRA, TSURU GS1, TSUBAME, LUCINO.	1991/1996	257	
1.6L	CA-1226-1G	TSURU GSI, GSII, SENTRA MEXICO, TSUBAME.	1997/2014	257	
1.6L	CA-1227-G	SENTRA AMERICANO, PULSAR NX.	1989/1990	257	
1.6L	CA-1242-2ML	MARCH, VERSA.	2012/2014	258	
1.6L	CA-1550-ML	PLATINA, CLIO, KANGOO CABEZA DE MLS).	2002/2009	258	
1.6L	CA-1550-G	PLATINA, CLIO, KANGOO, (CABEZA DE GRAFITO).	2002/2009	258	
1.8L	CA-1214-G	200SX, STANZA	1982/1988	258	
1.8L	CA-1234-ML	SENTRA (CABEZA DE MLS).	2000/2003	258	
1.8L	CA-1234-G	SENTRA, (CABEZA DE GRAFITO).	2000/2003	258	
1.8L	CA-1238-G	TIIDA, SENTRA, VERSA.	2007/2011	258	
1.8L	CA-1238-ML	TIIDA, SENTRA, VERSA.	2007/2011	258	
<b>NISSAN</b>	2.0L	CA-1214-G	200SX, STANZA.	1982/1988	259
	2.0L	CA-1218-G	200SX, PICK UP 720, 710, 620, 510.	1977/1980	259
	2.0L	CA-1222-G	200SX, PICK UP, 510.	1980/1981	259
	2.0L	CA-1228-G	200SX, LUCINO, SENTRA, TSURU 2000 GSR.	1992/2000	259
	2.0L	CA-1238-ML	SENTRA.	2007/2011	259
	2.4L	CA-1224-G	CAMIONETAS VAN, PICK-UP 720, D21.	1983/1989	259
	2.4L	CA-1225-G	ICHI VAN, PICK-UP D21, ESTAQUITAS.	1989/1993	259
	2.4L	CA-1232-G	FRONTIER, PICK UP, URVAN.	2000/2006	259
	2.4L	CA-1233-G	SOLO AUTOS ALTIMA.	1993/1999	260
	2.5L	CA-1235-G	X-TRAIL, ALTIMA, SENTRA (CABEZA DE GRAFITO).	2002/2006	260
	2.5L	CA-1235-ML	X-TRAIL, ALTIMA, SENTRA (CABEZA DE MLS).	2002/2006	260
	2.5L	CA-1245-G	ALTIMA, SENTRA, URVAN, FRONTIER, ROGUE (CABEZA DE GRAFITO).	2007/2009	260
	2.5L	CA-1245-ML	ALTIMA, SENTRA, URVAN, FRONTIER, ROGUE (CABEZA DE MLS).	2007/2009	260
	2.5L	CA-1255-ML	URVAN, FRONTIER, EQUATOR (CABEZA DE MLS).	2005/2012	260
2.5L	CA-1255-G	URVAN, FRONTIER, EQUATOR (CABEZA DE GRAFITO).	2005/2012	260	
2.8L	CA-1221-B	280ZX,	1981/1983	260	
3.0L	CA-1229-G	FRONTIER, QUEST, X TERRA, MERCURY VILLAGER.	1986/1999	261	
3.0L	CA-1237-1ML	MAXIMA, INFINITI I30.	2000/2001	261	
3.0L	CA-1243-ML	URVAN TURBODIESEL.	2001/2009	261	
3.0L	CA-1244-ML	MAXIMA, INFINITI I30.	1995/1999	261	
3.3L	CA-1229-1G	PATHFINDER, FRONTIER, X-TERRA.	1996/2004	261	



MARCA	LITROS	Numero DC	MODELO	AÑO	PÁGINA
MAKE	LITERS	DC Number	MODEL	YEAR	PAGE
<b>NISSAN</b>	3.5L	CA-1236-ML	MAXIMA, ALTIMA, MURANO, QUEST, 350Z, INFINITI G35, I35. (IZQUIERDA)	2002/2008	261
	3.5L	CA-1236-1ML	MAXIMA, ALTIMA, MURANO, QUEST, 350Z, INFINITI G35, I35. (DERECHA)	2002/2008	261
	3.5L	CA-1239-ML	PATHFINDER, INFINITI, QX4, FX35. (IZQUIERDA)	2001/2004	261
	3.5L	CA-1239-1ML	PATHFINDER, INFINITI, QX4, FX35. (DERECHA)	2001/2004	262
	5.6L	CA-1256-G	ARMADA, TITAN, PATHFINDER (CABEZA DE GRAFITO). (DERECHA)	2004/2010	262
	5.6L	CA-1256-1G	TITAN, ARMADA, PATHFINDER (CABEZA DE GRAFITO). (IZQUIERDA)	2004/2010	262
<b>RENAULT</b>	1.6L	CA-1530-G	R12, R18, TS.	1975/1984	262
	1.5L	CA-1304-G	TERCEL.	1987/1994	263
	1.5L	CA-1305-ML	TERCEL, PASEO.	1992/1995	263
	1.5L	CA-1305-1G	TERCEL, PASEO.	1995/1999	263
	1.6L	CA-1301-B	COROLLA, CARINA.	1977/1979	263
	1.6L	CA-1307-G	COROLLA, PRIZM.	1993/1997	263
	1.8L	CA-1307-ML	COROLLA, CELICA, GEO PRIZM.	1993/1997	263
	1.9L	CA-1300-B	CELICA, CORONA, PICK-UP.	1968/1974	263
	1.8L	CA-1302-ML	CELICA, COROLLA, MR2, MATRIX, PONTIAC VIBE, PRIZM.	1998/2009	263
	2.0L	CA-1321-G	CELICA, CAMRY.	1983/1986	264
	2.0L	CA-1323-G	VAN CARGA.	1984/1985	264
	2.0L	CA-1324-G	CAMRY, CELICA, MR2.	1987/1995	264
	2.0L	CA-1322-G	CAMRY, CELICA, MR2.	1987/1995	264
	2.0L	CA-1325-ML	RAV4.	2001/2003	264
	2.2L	CA-1310-G	CELICA, CORONA PICK-UP.	1975/1980	264
	2.2L	CA-1322-ML	MR2 TURBO.	1991	264
	2.2L	CA-1322-G	CAMRY, CELICA, MR2.	1987/1995	264
	2.2L	CA-1324-G	CAMRY, CELICA, MR2.	1987/1995	265
	2.4L	CA-1327-G	PREVIA.	1991/1997	265
<b>TOYOTA</b>	2.4L	CA-1328-ML	RAV4, CAMRY, HIGHLANDER.	2002/2007	265
	2.4L	CA-1330-G	TACOMA.	1994/2004	265
	2.7L	CA-1352-G	TACOMA, T-100, 4RUNNER.	1994/2004	265
	2.7L	CA-1354-ML	HIACE, HILUX, VENZA,	2005/2010	265
	3.0L	CA-1350-G	4RUNNER, PICK-UP, T100.	1988/1995	265
	3.0L	CA-1351-G	4RUNNER, PICK-UP, T100.	1988/1995	265
	3.0L	CA-1353-G	SUPRA, LEXUS SC300, IS300, GS300.	1993/1998	266
	3.0L	CA-1353-ML	SUPRA, LEXUS, GS300, IS300, SC300	1992/2005	266
	3.0L	CA-1355-G	CAMRY, LEXUS ES300. (IZQUIERDA)	1992/1993	266
	3.0L	CA-1355-1G	CAMRY, LEXUS ES300. (DERECHA)	1992/1993	266
	3.0L	CA-1356-G	CAMRY, AVALON, SIENNA, SOLARA.	1994/2000	266
	3.0L	CA-1356-1G	CAMRY, AVALON, SIENNA, SOLARA.	1994/2000	266
	3.0L	CA-1356-ML	CAMRY, AVALON, SIENNA, SOLARA. (DERECHA)	1994/2000	266
	3.0L	CA-1356-1ML	CAMRY, AVALON, SIENNA, SOLARA. (IZQUIERDA)	1994/2000	266
	3.4L	CA-1357-G	TACOMA, 4RUNNER, T-100, TUNDRA. (IZQUIERDA)	1995/2004	267
	3.4L	CA-1358-G	TACOMA, 4RUNNER, T-100, TUNDRA. (DERECHA)	1995/2004	267
4.0L	CA-1361-G	LEXUS LS400, SC400. (IZQUIERDA)	1990/1997	267	
4.0L	CA-1361-1G	LEXUS LS400, SC400. (DERECHA)	1990/1997	267	
4.0L	CA-1361-1ML	LEXUS GS400, LS400, SC400. (IZQUIERDA)	1998/2000	267	
4.0L	CA-1361-ML	LEXUS GS400, LS400, SC400. (IZQUIERDA)	1998/2000	267	
4.0L	CA-1367-G	LAND CRUISER.	1988/1992	267	
4.2L	CA-1367-G	LAND CRUISER	1985/1987	267	
4.0L	CA-1365-ML	4RUNNER (DERECHA)	2004/2006	268	

MARCA	LITROS	Numero DC	MODELO	AÑO	PÁGINA
MAKE	LITERS	DC Number	MODEL	YEAR	PAGE
<b>TOYOTA</b>	3.0L	CA-1365-1ML	4RUNNER (IZQUIERDA)	2004/2006	268
	3.0L	CA-1369-ML	TUNDRA, LX570, LAND CRUISER, SEQUOIA. (DERECHA)	1992/1993	268
	3.0L	CA-1369-1ML	TUNDRA, LX570, LAND CRUISER, SEQUOIA. (DERECHA)	2007/2013	268
	1.2L	CA-1810-C	SEDAN.	1963/1965	269
	1.6L	CA-1835-G	LUPO, POLO, CROSSFOX, SPORT VAN, GOL.	2003/2014	269
	1.6L	CA-1835-ML	LUPO, POLO, CROSSFOX, (CABEZA MLS).	2005/2012	269
	1.8L	CA-1840-G	JETTA A2, GOLF, CORSAR, CABRIOLET, RABBIT.	1983/1998	269
	1.8L	CA-1852-ML	PASSAT, BEETLE, SHARAN, JETTA GLI, AUDI A4, A3.	2001/2012	269
	1.8L	CA-1852-G	PASSAT, AUDI A4, GOLF, BEETLE.	1996/2005	269
	1.9L	CA-1860-ML	EUROVAN, TRANSPORTER.	2006/2009	269
<b>VOLKSWAGEN</b>	2.0L	CA-1845-ML	JETTA A3, GOLF, CABRIO (CABEZA EN MLS).	1993/1999	269
	2.0L	CA-1845-G	JETTA A3, GOLF, CABRIO.	1993/1999	270
	2.0L	CA-1850-G	JETTA A4, GOLF, BEETLE, IBIZA (CABEZA EN GRAFITO).	2000/2007	270
	2.0L	CA-1850-ML1	JETTA A4, GOLF, BEETLE, IBIZA (CABEZA EN MLS).	2000/2007	270
	2.0L	CA-1850-ML	JETTA A4, GOLF, BEETLE, IBIZA (CABEZA EN MLS).	2000/2007	270
	2.0L	CA-1855-ML	PASSAT, JETTA GLI.	2010/2013	270
	2.0L	CA-1855-1ML	AUDI, A3, TT.	2008/2011	270
	2.5L	CA-1851-B	CARGOVAN, EUROVAN.	2001/2004	270
	2.5L	CA-1856-ML	BORA, BEETLE.	2005/2010	270
	2.5L	CA-1870-ML	EUROVAN, TRANSPORTER.	2001/2004	271
	2.8L	CA-1853-ML	PASSAT, AUDI A4, A6.	1997/2001	271
	2.8L	CA-1854-G	JETTA VR6, TRANSPORTER, SHARAN, GOLF GTI,	1992/2003	271



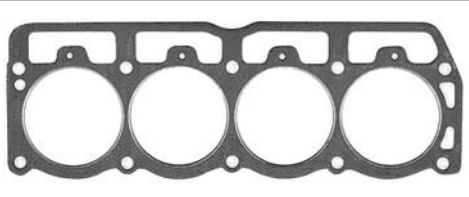
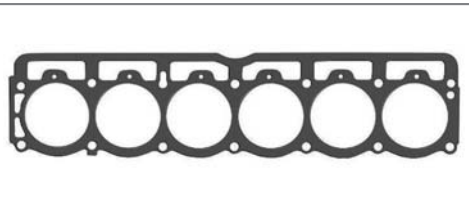
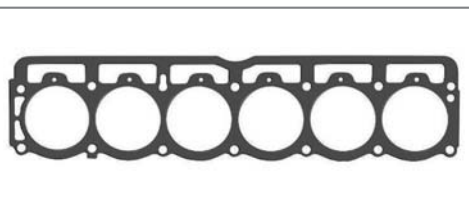
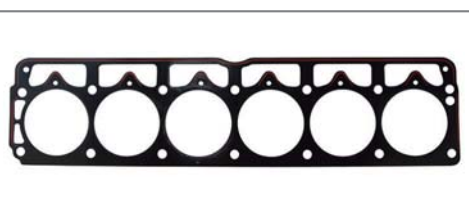
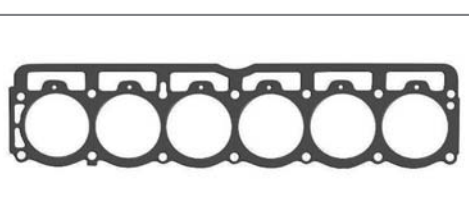
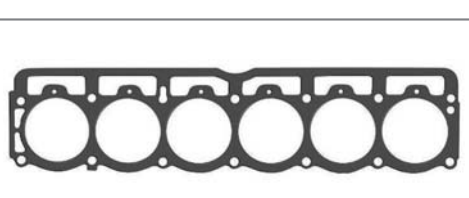
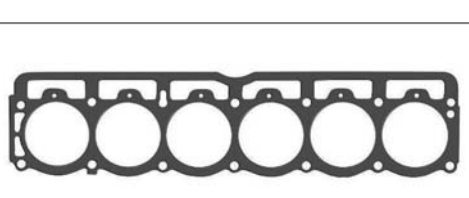

2.5L	MOTOR	MODELOS	DESDE / A	
	ENGINE	MODELS	FROM / TO	
CA-703-G	4L OHV 8V 3L SOHC 6V 61" SA310 4L AMC OHV 8V VIN U,C	EAGLE, WAGONEER, CHEROKEE, WRANGLER.	1983/1984	
3.2L	MOTOR	MODELOS	DESDE / A	
	ENGINE	MODELS	FROM / TO	
CA-710-G	3L SOHC 6v 61" L6 OHV 12V 199"	EAGLE, RAMBLER AMERICAN, PACER, AMBASSADOR, JAVELIN.	1965/1983	
3.8L	MOTOR	MODELOS	DESDE / A	
	ENGINE	MODELS	FROM / TO	
CA-710-G	L6 OHV 12V 232"	EAGLE, RAMBLER AMERICAN, PACER, AMBASSADOR, JAVELIN.	1965/1983	
4.0L	MOTOR	MODELOS	DESDE / A	
	ENGINE	MODELS	FROM / TO	
CA-715-G	L6 AMC OHV 12V 242"	EAGLE, CHEROKEE, WAGONEER, COMANCHE.	1987/1990	
4.2L	MOTOR	MODELOS	DESDE / A	
	ENGINE	MODELS	FROM / TO	
CA-710-G	L6 OHV 12V 258"	EAGLE, RAMBLER AMERICAN, PACER, AMBASSADOR, JAVELIN.	1965/1983	
4.2L	MOTOR	MODELOS	DESDE / A	
	ENGINE	MODELS	FROM / TO	
CA-710-G	L6 OHV 12V 258"	EAGLE, RAMBLER AMERICAN, PACER, AMBASSADOR, JAVELIN.	1965/1983	
4.6L	MOTOR	MODELOS	DESDE / A	
	ENGINE	MODELS	FROM / TO	
CA-710-G	L6 OHV 12V 282"	EAGLE, RAMBLER AMERICAN, PACER, WAGONEER, JAVELIN.	1965/1987	



1.0L	MOTOR	MODELOS	DESDE / A	
	ENGINE	MODELS	FROM / TO	
CA-201-G	4L SOHC.12 V G4HC	ATOS.	2000/2003	
1.1L	MOTOR	MODELOS	DESDE / A	
	ENGINE	MODELS	FROM / TO	
CA-201-1G	4L SOHC 12 V G4HC	ATOS.	2004/2009	
1.4L	MOTOR	MODELOS	DESDE / A	
	ENGINE	MODELS	FROM / TO	
CA-204-ML	4L, DOHC 16V G4EE G4KF	ATTITUDE.	2006/2011	
1.4L	MOTOR	MODELOS	DESDE / A	
	ENGINE	MODELS	FROM / TO	
CA-230-G	4L, SOHC 8V MOTOR MITSUBISHI G15B	COLT, MIRAGE, EXCEL.	1979/1991	
1.5L	MOTOR	MODELOS	DESDE / A	
	ENGINE	MODELS	FROM / TO	
CA-203-ML	4L, SOHC 12V G4EK	VERNA.	2000/2006	
1.5L	MOTOR	MODELOS	DESDE / A	
	ENGINE	MODELS	FROM / TO	
CA-230-G	4L, SOHC 8V MOTOR MITSUBISHI G15B	COLT, MIRAGE, EXCEL.	1979/1984	
1.8L	MOTOR	MODELOS	DESDE / A	
	ENGINE	MODELS	FROM / TO	
CA-205-G	4L SOHC 4G93	EXPO, COLT, MIRAGE	1993/1996	
1.8L	MOTOR	MODELOS	DESDE / A	
	ENGINE	MODELS	FROM / TO	
CA-237-G	4L, SOHC 8V MOTOR MITSUBISHI 4G37 VIN T	ECLIPSE, TALON, COLT, LASER.	1989/1994	







2.0L	MOTOR	MODELOS	DESDE / A	
	ENGINE	MODELS	FROM / TO	
CA-235-1G	4L, SOHC 8V MOTOR MITSUBISHI G63B 4G63 VIN V	COLT, VISTA, GALANT, 2000GTX, STELLAR.	1984/1990	
2.0L	MOTOR	MODELOS	DESDE / A	
	ENGINE	MODELS	FROM / TO	
CA-235-G	4L, SOHC 8V MOTOR MITSUBISHI G63B 4G63 VIN V	COLT, VISTA, GALANT, 2000GTX, STELLAR.	1984/1990	
2.0L	MOTOR	MODELOS	DESDE / A	
	ENGINE	MODELS	FROM / TO	
CA-242-G	4L, DOHC 16V VIN C, Y	NEON, SEBRING.	1995/1999	
2.0L	MOTOR	MODELOS	DESDE / A	
	ENGINE	MODELS	FROM / TO	
CA-242-ML	4L SOHC 16V	NEON, STRATUS ,BREEZE.	1996/2000	
2.0L	MOTOR	MODELOS	DESDE / A	
	ENGINE	MODELS	FROM / TO	
CA-242-1ML	4L, SOHC 16V VIN C	NEON.	1996/1999	
2.2L	MOTOR	MODELOS	DESDE / A	
	ENGINE	MODELS	FROM / TO	
CA-240-G	4L, SOHC 8V VIN K C D EXCEPTO TURBO	VOYAGER, DART K, SHADOW, SPIRIT, DAYTONA, LeBARON.	1981/1988	
2.4L	MOTOR	MODELOS	DESDE / A	
	ENGINE	MODELS	FROM / TO	
CA-202-G	4L, SOHC 8V G64B 464B	H-100.	2003/2005	
2.4L	MOTOR	MODELOS	DESDE / A	
	ENGINE	MODELS	FROM / TO	
CA-226-G	4L, DOHC 16V MOTOR GEMA VIN W, B	PATRIOT, JOURNEY, COMPASS, CALIBER, AVENGER (CABEZA EN GRAFITO).	2007/2013	



2.4L	MOTOR	MODELOS	DESDE / A	
	ENGINE	MODELS	FROM / TO	
CA-226-ML	4L, DOHC 16V MOTOR GEMA VIN W, B	PATRIOT, JOURNEY, COMPASS, CALIBER, AVENGER (CABEZA EN MLS).	2007/2013	
2.4L	MOTOR	MODELOS	DESDE / A	
	ENGINE	MODELS	FROM / TO	
CA-243-ML	4L, DOHC 16V VIN B	PT CRUISER.	2001	
2.4L	MOTOR	MODELOS	DESDE / A	
	ENGINE	MODELS	FROM / TO	
CA-245-G	4L, DOHC 16V VIN X, B	STRATUS, CIRRUS, VOYAGER, SEBRING.	1995/2000	
2.4L	MOTOR	MODELOS	DESDE / A	
	ENGINE	MODELS	FROM / TO	
CA-245-1ML	4L, DOHC 16V VIN X, B	PT CRUISER (CABEZA EN MLS).	2002/2007	
2.4L	MOTOR	MODELOS	DESDE / A	
	ENGINE	MODELS	FROM / TO	
CA-245-1G	4L, DOHC 16V VIN X, B	PT CRUISER (CABEZA EN GRAFITO).	2002/2007	
2.4L	MOTOR	MODELOS	DESDE / A	
	ENGINE	MODELS	FROM / TO	
CA-251-ML	4L, SOHC 16V MOTOR 4G64	ECLIPSE, GALANT, SEBRING.	2001/2005	
2.4L	MOTOR	MODELOS	DESDE / A	
	ENGINE	MODELS	FROM / TO	
CA-251-1G	4L SOHC 16V "4G64"	ECLIPSE, GALANT.	1993/1996	
2.5L	MOTOR	MODELOS	DESDE / A	
	ENGINE	MODELS	FROM / TO	
CA-206-D	4L, SOHC 8V TDI MOTOR MITSUBISHI 4D56T	H-100.	2005/2009	

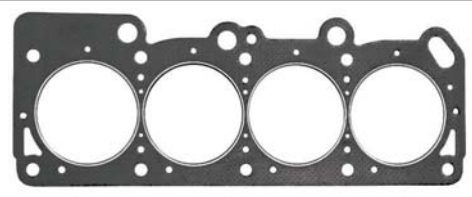

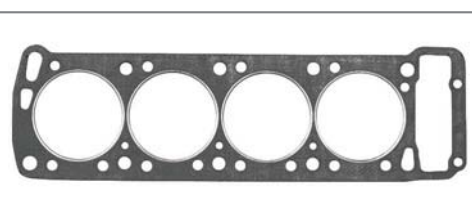
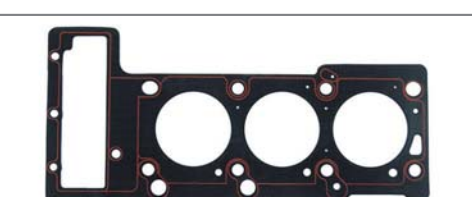
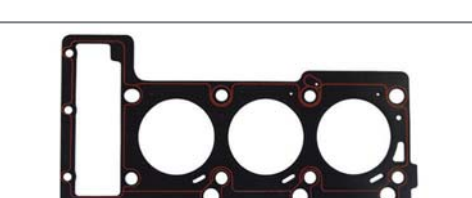
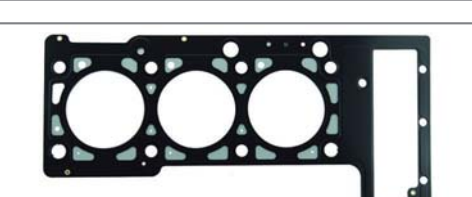
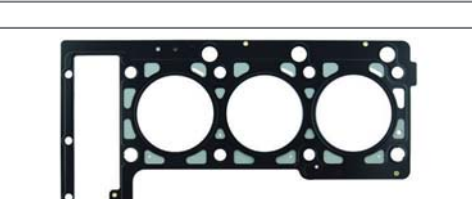
2.5L	MOTOR	MODELOS	DESDE / A	
	ENGINE	MODELS	FROM / TO	
CA-240-G	4L, SOHC 8V VIN K C D EXCEPTO TURBO	VOYAGER, DART K, SHADOW, SPIRIT, DAYTONA, LeBARON.	1981/1988	
2.5L	MOTOR	MODELOS	DESDE / A	
	ENGINE	MODELS	FROM / TO	
CA-252-ML	V6, SOHC 24V	STRATUS, CIRRUS, SEBRING (CABEZAS DE MLS).	1995/2000	
2.5L	MOTOR	MODELOS	DESDE / A	
	ENGINE	MODELS	FROM / TO	
CA-252-G	V6, SOHC 24V MOTOR MITSUBISHI 6G73 VIN H	STRATUS, CIRRUS, SEBRING (CABEZAS DE GRAFITO).	1995/2000	
2.6L	MOTOR	MODELOS	DESDE / A	
	ENGINE	MODELS	FROM / TO	
CA-250-G	4L, SOHC 8V MOTOR G54B VIN G, E	CARAVAN, VOYAGER, LeBARON, RAM 50.	1981/1989	
2.7L	MOTOR	MODELOS	DESDE / A	
	ENGINE	MODELS	FROM / TO	
CA-280-G	V6, SOHC 24V	INTREPID, CONCORDE, CIRRUS, SEBRING. (IZQUIERDA)	1998/2010	
2.7L	MOTOR	MODELOS	DESDE / A	
	ENGINE	MODELS	FROM / TO	
CA-281-G	V6, SOHC 24V	INTREPID, CONCORDE, CIRRUS, SEBRING. (DERECHA)	1998/2010	
2.7L	MOTOR	MODELOS	DESDE / A	
	ENGINE	MODELS	FROM / TO	
CA-280-ML	V6, DOHC 24V VIN R	INTREPID, CONCORDE. (IZQUIERDA)	1998/2000	
2.7L	MOTOR	MODELOS	DESDE / A	
	ENGINE	MODELS	FROM / TO	
CA-281-ML	V6, DOHC 24V VIN R	INTREPID, CONCORDE. (DERECHA)	1998/2000	



3.0L	MOTOR	MODELOS	DESDE / A	
	ENGINE	MODELS	FROM / TO	
CA-253-G	V6, SOHC 12V MOTOR MITSUBISHI 6G72 MULT. ESCAPE S/ DEFLECTOR	CARAVAN, VOYAGER, LeBARON, DYNASTY.	1987/1995	
3.2L	MOTOR	MODELOS	DESDE / A	
	ENGINE	MODELS	FROM / TO	
CA-225-G	6L OHV VIN "A"	AUTOS Y CAMIONES.	1960/1991	
3.2L	MOTOR	MODELOS	DESDE / A	
	ENGINE	MODELS	FROM / TO	
CA-266-ML	V6 SOHC 24V	INTREPID, CONCORDE. (IZQUIERDA)	1998/2001	
3.2L	MOTOR	MODELOS	DESDE / A	
	ENGINE	MODELS	FROM / TO	
CA-266-1ML	V6 SOHC 24V	INTREPID, CONCORDE. (DERECHA)	1998/2001	
3.3L	MOTOR	MODELOS	DESDE / A	
	ENGINE	MODELS	FROM / TO	
CA-254-G	V6, OHV 12V NO INCLUYE CONHA DE ADMISION. (IZQUIERDA)	GRAND CARAVAN, GRAND VOYAGER. (IZQUIERDA)	1990/2000	
3.3L	MOTOR	MODELOS	DESDE / A	
	ENGINE	MODELS	FROM / TO	
CA-255-G	V6, OHV 12V NO INCLUYE CONHA DE ADMISION. (DERECHA)	GRAND CARAVAN, GRAND VOYAGER. (DERECHA)	1990/2000	
3.3L	MOTOR	MODELOS	DESDE / A	
	ENGINE	MODELS	FROM / TO	
CA-255-ML	V6, OHV 12V VIN R, 3, H, E	TOWN & COUNTRY, CARAVAN, VOYAGER. (DERECHA)	2001/2010	
3.3L	MOTOR	MODELOS	DESDE / A	
	ENGINE	MODELS	FROM / TO	
CA-254-ML	V6, OHV 12V VIN R, 3, H, E	TOWN & COUNTRY, CARAVAN, VOYAGER. (IZQUIERDA)	2001/2010	







3.5L	MOTOR	MODELOS	DESDE / A	
	ENGINE	MODELS	FROM / TO	
CA-262-ML	V6 SOHC 24V VIN "F,G"	CONCORDE, INTREPID (CABEZAS DE MLS). (DERECHA)	1993/1997	
3.5L	MOTOR	MODELOS	DESDE / A	
	ENGINE	MODELS	FROM / TO	
CA-261-ML	V6 SOHC 24V VIN "F,G"	CONCORDE, INTREPID (CABEZAS DE MLS). (IZQUIERDA)	1993/1997	
3.5L	MOTOR	MODELOS	DESDE / A	
	ENGINE	MODELS	FROM / TO	
CA-261-G	V6, SOHC 24V VIN F	INTREPID, CONCORDE, NEW YORKER. (IZQUIERDA)	1993/1997	
3.5L	MOTOR	MODELOS	DESDE / A	
	ENGINE	MODELS	FROM / TO	
CA-262-G	V6, SOHC 24V VIN F	INTREPID, CONCORDE, NEW YORKER. (DERECHA)	1993/1997	
3.5L	MOTOR	MODELOS	DESDE / A	
	ENGINE	MODELS	FROM / TO	
CA-268-ML	V6, SOHC 24V	JOURNEY, AVENGER, SEBRING, CHARGER, CHALLENGER. (IZQUIERDA)	2007/2010	
3.5L	MOTOR	MODELOS	DESDE / A	
	ENGINE	MODELS	FROM / TO	
CA-268-1ML	V6, SOHC 24V	JOURNEY, AVENGER, SEBRING, CHARGER, CHALLENGER. (DERECHA)	2007/2010	
3.6L	MOTOR	MODELOS	DESDE / A	
	ENGINE	MODELS	FROM / TO	
CA-269-1ML	V6, DOHC 24V MOTOR PENTASTAR VIN G	TOWN & COUNTRY, CARAVAN, AVENGER, JOURNEY, CHALLENGER, RAM 1500, 200. (IZQUIERDA)	2011/2013	
3.6L	MOTOR	MODELOS	DESDE / A	
	ENGINE	MODELS	FROM / TO	
CA-269-ML	V6, DOHC 24V MOTOR PENTASTAR VIN G	TOWN & COUNTRY, CARAVAN, AVENGER, JOURNEY, CHALLENGER, RAM 1500, 200. (DERECHA)	2011/2013	



3.7L	MOTOR	MODELOS	DESDE / A	
	ENGINE	MODELS	FROM / TO	
CA-271-ML	V6, SOHC 12V VIN K CABEZA DE MLS	DAKOTA, RAM 1500, JEEP LIBERTY (CABEZA EN MLS).	2002/2005	
3.7L	MOTOR	MODELOS	DESDE / A	
	ENGINE	MODELS	FROM / TO	
CA-271-G	V6, SOHC 12V VIN K CABEZA DE GRAFITO	DAKOTA, RAM 1500, JEEP LIBERTY (CABEZA EN GRAFITO).	2002/2005	
3.8L	MOTOR	MODELOS	DESDE / A	
	ENGINE	MODELS	FROM / TO	
CA-210-S	6L 218",230" ENGINES	AUTOS Y CAMIONES.	1949/1960	
3.8L	MOTOR	MODELOS	DESDE / A	
	ENGINE	MODELS	FROM / TO	
CA-254-1G	V6, OHV 12V VIN P, L NO INCLUYE VALLE DE ADMISION	TOWN & COUNTRY, GRAND CARAVAN, GRAND VOYAGER (CARTER Y PUNTERIAS DE SILICON). (IZQUIERDA)	1998/2000	
3.8L	MOTOR	MODELOS	DESDE / A	
	ENGINE	MODELS	FROM / TO	
CA-255-1G	V6 OHV 12V VIN L, P	TOWN & COUNTRY, GRAND CARAVAN, PACIFICA. (DERECHA)	2002/2008	
3.8L	MOTOR	MODELOS	DESDE / A	
	ENGINE	MODELS	FROM / TO	
CA-263-G	V6, OHV 12V VIN L NO INCLUYE ADMISION	TOWN & COUNTRY, CARAVAN, VOYAGER (CARTER Y PUNTERIAS DE CORCHO). (DERECHA).	1998/2001	
3.8L	MOTOR	MODELOS	DESDE / A	
	ENGINE	MODELS	FROM / TO	
CA-263-ML	V6, OHV 12V VIN R, 3, H, E	TOWN & COUNTRY, CARAVAN, VOYAGER.	2001/2010	
3.8L	MOTOR	MODELOS	DESDE / A	
	ENGINE	MODELS	FROM / TO	
CA-264-G	V6, OHV 12V VIN L NO INCLUYE ADMISION	TOWN & COUNTRY, CARAVAN, VOYAGER (CARTER Y PUNTERIAS DE CORCHO). (IZQUIERDA).	1998/2001	

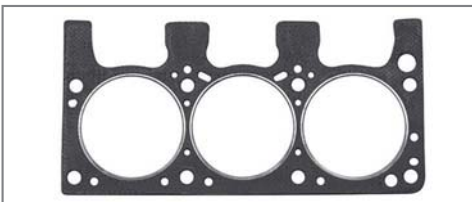
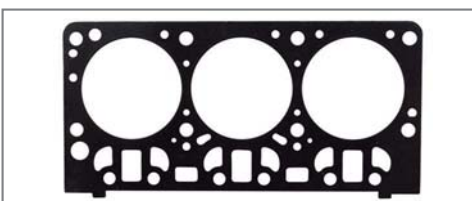
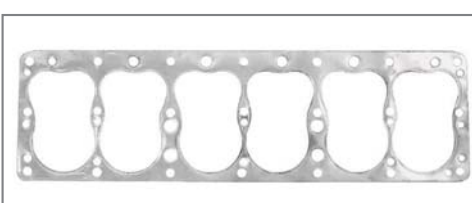
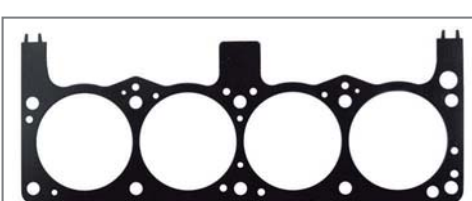

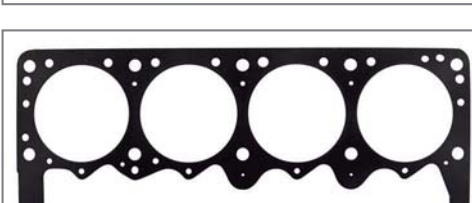
<b>3.8L</b>	MOTOR	MODELOS	DESDE / A	
	ENGINE	MODELS	FROM / TO	
CA-264-ML	V6 OHV 12V VIN "R"	GRAND CARAVAN, VOYAGER.	2001/2009	
<b>3.9L</b>	MOTOR	MODELOS	DESDE / A	
	ENGINE	MODELS	FROM / TO	
CA-265-G	V6, OHV 12V VIN X	DAKOTA AMERICANAS, B150, B250	1987/1989	
<b>3.9L</b>	MOTOR	MODELOS	DESDE / A	
	ENGINE	MODELS	FROM / TO	
CA-270-G	V6, OHV 12V VIN X MOTOR MAGNUM	DAKOTA, RAM 1500, RAM VAN.	1992/1997	
<b>4.1L</b>	MOTOR	MODELOS	DESDE / A	
	ENGINE	MODELS	FROM / TO	
CA-200-S	L6, OHV MOTOR "251"	NEWPORT, TOWN & COUNTRY, WINDSOR	1954/1960	
<b>4.5L</b>	MOTOR	MODELOS	DESDE / A	
	ENGINE	MODELS	FROM / TO	
CA-260-G	V8, OHV 16V	VALIANT, DART, CHARGER, BARRACUDA, MONACO, CORONET.	1964/1969	
<b>4.7L</b>	MOTOR	MODELOS	DESDE / A	
	ENGINE	MODELS	FROM / TO	
CA-272-ML	V8, SOHC 16V VIN J, P, N MOTOR POWER TECH CABEZA DE MLS	RAM 1500, 2500, GRAND CHEROKEE, DURANGO, DAKOTA (CABEZA EN MLS).	1999/2005	
<b>4.7L</b>	MOTOR	MODELOS	DESDE / A	
	ENGINE	MODELS	FROM / TO	
CA-272-G	V8, SOHC 16V VIN J, P, N MOTOR POWER TECH CABEZA DE GRAFITO	RAM 1500, 2500, GRAND CHEROKEE, DURANGO, DAKOTA (CABEZA EN GRAFITO).	1999/2005	
<b>5.2L</b>	MOTOR	MODELOS	DESDE / A	
	ENGINE	MODELS	FROM / TO	
CA-256-G	V8, OHV 16V	CORONET, CHARGER, SERIES D100, D200, D300.	1959/1966	



<b>5.2L</b>	MOTOR	MODELOS	DESDE / A	
	ENGINE	MODELS	FROM / TO	
CA-260-G	V8, OHV 16V	VALIANT, DART, CHARGER, BARRACUDA, MONACO, CORONET.	1964/1969	
<b>5.2L</b>	MOTOR	MODELOS	DESDE / A	
	ENGINE	MODELS	FROM / TO	
CA-275-G	V8, OHV 16V VIN Y	B150, B250, B350, W150, W250, RAMCHARGER, DAKOTA.	1989/1992	
<b>5.6L</b>	MOTOR	MODELOS	DESDE / A	
	ENGINE	MODELS	FROM / TO	
CA-718-G	V8 OHV 16V 343"	AMBASSADOR, JAVELIN, RAMBLER.	1967/1974	
<b>5.7L</b>	MOTOR	MODELOS	DESDE / A	
	ENGINE	MODELS	FROM / TO	
CA-273-ML	V8, OHV 16V MOTOR HEMI CABEZA DE MLS	RAM 1500, 2500, 3500, DURANGO, GRAND CHEROKEE, COMANDER. (IZQUIERDA)	2003/2009	
<b>5.7L</b>	MOTOR	MODELOS	DESDE / A	
	ENGINE	MODELS	FROM / TO	
CA-273-G	V8, OHV 16V MOTOR HEMI CABEZA DE GRAFITO	300C, CHALLENGER, CHARGER. (IZQUIERDA)	2005/2012	
<b>5.9L</b>	MOTOR	MODELOS	DESDE / A	
	ENGINE	MODELS	FROM / TO	
CA-249-ML	6L, OHV 12V Y 24V MOTOR CUMMINS	RAM 2500, 3500 CUMMINS TURBO	2003/2008	
<b>5.9L</b>	MOTOR	MODELOS	DESDE / A	
	ENGINE	MODELS	FROM / TO	
CA-718-G	V8 OHV 16V 360"	AMBASSADOR, JAVELIN, MATA-DOR, CHEROKEE, WAGONEER, GRAND WAGONNER.	1971/1991	
<b>6.4L</b>	MOTOR	MODELOS	DESDE / A	
	ENGINE	MODELS	FROM / TO	
CA-718-G	V8 OHV 16V 390"	AMBASSADOR, JAVELIN, RAMBLER.	1971/1978	





6.6L	MOTOR	MODELOS	DESDE / A
	ENGINE	MODELS	FROM / TO
CA-718-G	V8 OHV 16V 401"	AMBASSADOR, JAVELIN, MATA-DOR, CHEROKEE, WAGONNER	1971/1983

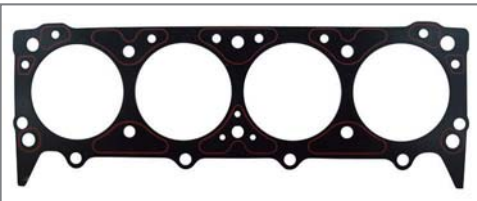

7.2L	MOTOR	MODELOS	DESDE / A
	ENGINE	MODELS	FROM / TO
CA-258-G	V8, OHV 16V	CHARGER, CORONET, BARRA-CUDA, CHALLENGER, MONACO, CORONET, FURY	1966/1978

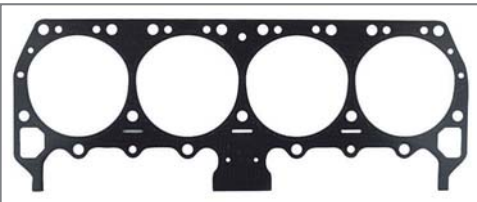

8.0L	MOTOR	MODELOS	DESDE / A
	ENGINE	MODELS	FROM / TO
CA-282-G	V10, OHV 20 V VIN W,E	RAM 2500, 3500, VIPER.	1992/2003

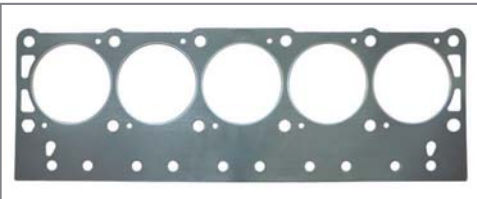



1.3L	MOTOR	MODELOS	DESDE / A	
	ENGINE	MODELS	FROM / TO	
CA-302-G	4L OHV 8V ENDURA	FIESTA.	1997/2001	
1.4L	MOTOR	MODELOS	DESDE / A	
	ENGINE	MODELS	FROM / TO	
CA-307-ML	4L DOHC 16V FHA FHD FHE FHF	FIESTA.	1998/2001	
1.4L	MOTOR	MODELOS	DESDE / A	
	ENGINE	MODELS	FROM / TO	
CA-307-G	4L SOHC 8V ZETEC SE	FIESTA.	1998/2000	
1.6L	MOTOR	MODELOS	DESDE / A	
	ENGINE	MODELS	FROM / TO	
CA-317-G	4L SOHC 8V ZETEC ROCAM	FIESTA, IKON, Ka, COURIER.	2001/2010	
1.8L	MOTOR	MODELOS	DESDE / A	
	ENGINE	MODELS	FROM / TO	
CA-303-2ML	4L DOHC 16V	ESCORT, TRACER.	1991/1996	
1.9L	MOTOR	MODELOS	DESDE / A	
	ENGINE	MODELS	FROM / TO	
CA-303-G	4L SOHC 8V	MERCURY TRACER, ESCORT.	1981/1999	
1.9L	MOTOR	MODELOS	DESDE / A	
	ENGINE	MODELS	FROM / TO	
CA-303-2G	4L SOHC 8V	ESCORT TRACER.	1991/1996	
2.0L	MOTOR	MODELOS	DESDE / A	
	ENGINE	MODELS	FROM / TO	
CA-303-1G	4L SOHC 8V	ESCORT, TRACER, FOCUS.	1981/2004	



2.0L	MOTOR ENGINE	MODELOS MODELS	DESDE / A FROM / TO	
CA-303-1ML	4L SOHC 8V SPI VIN P	FOCUS.	2000/2004	
2.0L	MOTOR ENGINE	MODELOS MODELS	DESDE / A FROM / TO	
CA-304-G	4L OHV	MAZDA B2000, COURIER.	1970/1984	
2.0L	MOTOR ENGINE	MODELOS MODELS	DESDE / A FROM / TO	
CA-306-G	4L SOHC 8V CARB	RANGER.	1983/1986	
2.0L	MOTOR ENGINE	MODELOS MODELS	DESDE / A FROM / TO	
CA-313-ML	4L DOHC 16V VIN 3 VIN Z	CONTOUR, MYSTIQUE, ESCORT,	1995/1999	
2.0L	MOTOR ENGINE	MODELOS MODELS	DESDE / A FROM / TO	
CA-313-G	4L DOHC 16V	CONTOUR, ESCORT, FOCUS, ZX2.	1995/1997	
2.0L	MOTOR ENGINE	MODELOS MODELS	DESDE / A FROM / TO	
CA-348-ML	4L DOHC 16V DURATEC	ECOSPORT, MEXICO.	2005/2009	
2.0L	MOTOR ENGINE	MODELOS MODELS	DESDE / A FROM / TO	
CA-348-G	4L DOHC 16V VIN D,H	ECOSPORT, FOCUS.	2001/2010	
2.2L	MOTOR ENGINE	MODELOS MODELS	DESDE / A FROM / TO	
CA-321-ML	4L DOHC 16V TURBODIESEL	TRANSIT VAN.	2008/2012	



<b>2.3L</b>	MOTOR	MODELOS	DESDE / A	
	ENGINE	MODELS	FROM / TO	
CA-300-G	4L OHV 8V VIN R S X	TEMPO, TOPAZ.	1984/1994	
<b>2.3L</b>	MOTOR	MODELOS	DESDE / A	
	ENGINE	MODELS	FROM / TO	
CA-305-G	4L SOHC 8V	RANGER.	1974/2002	
<b>2.3L</b>	MOTOR	MODELOS	DESDE / A	
	ENGINE	MODELS	FROM / TO	
CA-346-ML	4L DOHC 16V DURATEC VIN Z	FUSION, MILAN, MAZDA 3.	2006/2009	
<b>2.4L</b>	MOTOR	MODELOS	DESDE / A	
	ENGINE	MODELS	FROM / TO	
CA-320-G	6L OHV	FALCON, MAVERICK, CUSTOM ECONOLINE.	1960/1983	
<b>2.5L</b>	MOTOR	MODELOS	DESDE / A	
	ENGINE	MODELS	FROM / TO	
CA-311-ML	V6 DOHC 24V	CONTOUR, MYSTIQUE, MAZDA MPV. (DERECHA)	1995/2000	
<b>2.5L</b>	MOTOR	MODELOS	DESDE / A	
	ENGINE	MODELS	FROM / TO	
CA-312-ML	V6 DOHC 24V	CONTOUR, MYSTIQUE. (IZQUIERDA)	1995/2000	
<b>2.5L</b>	MOTOR	MODELOS	DESDE / A	
	ENGINE	MODELS	FROM / TO	
CA-319-ML	V6 DOHC 24V KL-ZE	PROBE, 626, MILLENIA. (DERECHA)	1993/1997	
<b>2.5L</b>	MOTOR	MODELOS	DESDE / A	
	ENGINE	MODELS	FROM / TO	
CA-319-ML1	V6 DOHC 24V KL-ZE	PROBE, 626, MILLENIA. (IZQUIERDA)	1993/1997	





2.8L	MOTOR	MODELOS	DESDE / A	
	ENGINE	MODELS	FROM / TO	
CA-315-G	V6 OHV 12V	AEROSTAR, BRONCO II, RANGER. (IZQUIERDA)	1974/1986	
2.8L	MOTOR	MODELOS	DESDE / A	
	ENGINE	MODELS	FROM / TO	
CA-316-G	V6 OHV 12V VIN Z	BRONCO II, RANGER. (DERECHA)	1974/1986	
2.8L	MOTOR	MODELOS	DESDE / A	
	ENGINE	MODELS	FROM / TO	
CA-320-G	6L OHV (144,170,200,250)	FALCON, MAVERICK, CUSTOM ECONOLINE	1960/1972	
2.9L	MOTOR	MODELOS	DESDE / A	
	ENGINE	MODELS	FROM / TO	
CA-308-G	V6 OHV 12V	EXPLORER, RANGER. (IZQUIERDA)	1986/1992	
2.9L	MOTOR	MODELOS	DESDE / A	
	ENGINE	MODELS	FROM / TO	
CA-309-G	V6 OHV 12V	EXPLORER, RANGER. (DERECHA)	1986/1992	
3.0L	MOTOR	MODELOS	DESDE / A	
	ENGINE	MODELS	FROM / TO	
CA-318-G	V6 OHV 12V VULCAN F.I.VIN U VIN 1	RANGER, AEROSTAR, TAURUS.	1986/1990	
3.0L	MOTOR	MODELOS	DESDE / A	
	ENGINE	MODELS	FROM / TO	
CA-322-G	V6 OHV 12V VIN U	AEROSTAR, B3000. (IZQUIERDA)	1986/1995	
3.0L	MOTOR	MODELOS	DESDE / A	
	ENGINE	MODELS	FROM / TO	
CA-323-G	V6 OHV 12V VIN U	AEROSTAR, B3000. (DERECHA)	1986/1995	



<b>3.0L</b>	MOTOR	MODELOS	DESDE / A	
	ENGINE	MODELS	FROM / TO	
CA-326-G	V6 DOHC 24V	ESCAPE, TAURUS, SABLE. (IZQUIERDA)	1999/2004	
<b>3.0L</b>	MOTOR	MODELOS	DESDE / A	
	ENGINE	MODELS	FROM / TO	
CA-326-ML	V6 DOHC DURATEC	TAURUS, SABLE. (IZQUIERDA)	2001/2004	
<b>3.0L</b>	MOTOR	MODELOS	DESDE / A	
	ENGINE	MODELS	FROM / TO	
CA-327-G	V6 DOHC 24V	ESCAPE, TAURUS, SABLE. (DERECHA)	2001/2004	
<b>3.0L</b>	MOTOR	MODELOS	DESDE / A	
	ENGINE	MODELS	FROM / TO	
CA-327-ML	V6 DOHC DURATEC	TAURUS, SABLE. (DERECHA)	2001/2004	
<b>3.5L</b>	MOTOR	MODELOS	DESDE / A	
	ENGINE	MODELS	FROM / TO	
CA-310-G	V6 OHV 12V	CUSTOM, WAGON PICK-UP.	1954-1964	
<b>3.8L</b>	MOTOR	MODELOS	DESDE / A	
	ENGINE	MODELS	FROM / TO	
CA-330-G	V6 OHV 12 CARB.	FORD FAIRMONT.	1982/1983	
<b>3.8L</b>	MOTOR	MODELOS	DESDE / A	
	ENGINE	MODELS	FROM / TO	
CA-332-1G	V6 OHV 12V MPFI	WINDSTAR.	1994/1995	
<b>3.8L</b>	MOTOR	MODELOS	DESDE / A	
	ENGINE	MODELS	FROM / TO	
CA-332-G	V6 OHV 12V MPFI	WINDSTAR.	1994/1995	



<b>3.8L</b>	MOTOR	MODELOS	DESDE / A	
	ENGINE	MODELS	FROM / TO	
CA-341-ML	V6 OHV 12V VIN 2,4	MUSTANG, WINDSTAR, LOBO F-150. (IZQUIERDA)	1995/2003	
<b>3.8L</b>	MOTOR	MODELOS	DESDE / A	
	ENGINE	MODELS	FROM / TO	
CA-341-G	V6 OHV 12V VIN 2,4	WINDSTAR, ECONOLINE. (IZQUIERDA)	1997/1998	
<b>3.8L</b>	MOTOR	MODELOS	DESDE / A	
	ENGINE	MODELS	FROM / TO	
CA-342-ML	V6 OHV 12V VIN 2,4	MUSTANG, WINDSTAR, LOBO F-150. (DERECHA)	1995/2003	
<b>3.8L</b>	MOTOR	MODELOS	DESDE / A	
	ENGINE	MODELS	FROM / TO	
CA-342-G	V6 OHV 12V VIN 2,4	WINDSTAR, ECONOLINE. (DERECHA)	1997/1998	
<b>3.9L</b>	MOTOR	MODELOS	DESDE / A	
	ENGINE	MODELS	FROM / TO	
CA-325-G	6L OHV 12V CARB.	AUTOS Y CAMIONETAS.	1965/1986	
<b>4.0L</b>	MOTOR	MODELOS	DESDE / A	
	ENGINE	MODELS	FROM / TO	
CA-335-G	V6 OHV 12V VIN X	AEROSTAR, EXPLORER, RANGER. (IZQUIERDA)	1990/2000	
<b>4.0L</b>	MOTOR	MODELOS	DESDE / A	
	ENGINE	MODELS	FROM / TO	
CA-336-G	V6 OHV 12V VIN X	AEROSTAR, EXPLORER, RANGER. (DERECHA)	1990/2000	
<b>4.0L</b>	MOTOR	MODELOS	DESDE / A	
	ENGINE	MODELS	FROM / TO	
CA-337-G	V6 SOHC 12V VIN E,K	EXPLORER, RANGER. (IZQUIERDA)	1997/2010	



<b>4.0L</b>	MOTOR	MODELOS	DESDE / A	
	ENGINE	MODELS	FROM / TO	
CA-338-G	V6 SOHC 12V VIN E,K	EXPLORER, RANGER. (DERECHA)	1997/2010	
<b>4.0L</b>	MOTOR	MODELOS	DESDE / A	
	ENGINE	MODELS	FROM / TO	
CA-337-ML	V6 OHV 12V VIN E,K	EXPLORER, MONTAINNER. (IZQUIERDA)	1997/2010	
<b>4.0L</b>	MOTOR	MODELOS	DESDE / A	
	ENGINE	MODELS	FROM / TO	
CA-338-ML	V6 OHV 12V VIN E,K	EXPLORER, MONTAINNER. (DERECHA)	1997/2010	
<b>4.2L</b>	MOTOR	MODELOS	DESDE / A	
	ENGINE	MODELS	FROM / TO	
CA-340-L	V8 OHV	AUTOS MERCURY. (IZQUIERDA).	1949/1954	
<b>4.2L</b>	MOTOR	MODELOS	DESDE / A	
	ENGINE	MODELS	FROM / TO	
CA-340-R	V8 OHV	AUTOS MERCURY. (DERECHA).	1949/1954	
<b>4.4L</b>	MOTOR	MODELOS	DESDE / A	
	ENGINE	MODELS	FROM / TO	
CA-350-B	V8 OHV 16V (272-292)	AUTOS Y CAMIONES.	1956/1964	
<b>4.6L</b>	MOTOR	MODELOS	DESDE / A	
	ENGINE	MODELS	FROM / TO	
CA-356-ML	V8 SOHC 16V TRITON	GRAND MARQUIS, F-150, F250, LOBO. (IZQUIERDA)	1991/2007	
<b>4.6L</b>	MOTOR	MODELOS	DESDE / A	
	ENGINE	MODELS	FROM / TO	
CA-357-ML	V8 SOHC 16V TRITON	GRAND MARQUIS, F-150, F250, LOBO. (DERECHA).	1991/2007	





<b>4.6L</b>	MOTOR	MODELOS	DESDE / A	
	ENGINE	MODELS	FROM / TO	
CA-357-ML1	V8 SOHC 16V TRITON	AUTOS Y CAMIONES MLS 4 CAPAS, F-150, F250, LOBO. (DERECHA)	1991/2007	
<b>4.6L</b>	MOTOR	MODELOS	DESDE / A	
	ENGINE	MODELS	FROM / TO	
CA-356-ML1	V8 SOHC 16V TRITON	AUTOS Y CAMIONES MLS 4 CAPAS, F-150, F250, LOBO. (IZQUIERDA)	1991/2007	
<b>4.6L</b>	MOTOR	MODELOS	DESDE / A	
	ENGINE	MODELS	FROM / TO	
CA-356-G	V8 SOHC 16V TRITON ROMEO	C.VICTORIA, CONTINENTAL, GRAND MARQUIS. (IZQUIERDA)	1991/1994	
<b>4.6L</b>	MOTOR	MODELOS	DESDE / A	
	ENGINE	MODELS	FROM / TO	
CA-357-G	V8 SOHC 16V TRITON	GRAND MARQUIS, F-150, F250, LOBO. (DERECHA)	1991/2007	
<b>5.0L</b>	MOTOR	MODELOS	DESDE / A	
	ENGINE	MODELS	FROM / TO	
CA-360-G	V8 OHV 16V 260,289,302,335,351,351W	AUTOS Y CAMIONES. (DERECHA)	1962/1997	
<b>5.4L</b>	MOTOR	MODELOS	DESDE / A	
	ENGINE	MODELS	FROM / TO	
CA-355-G	V8 OHV 16V (332)-352-360-390-410-427-428	AUTOS Y CAMIONES.	1961/1976	
<b>5.4L</b>	MOTOR	MODELOS	DESDE / A	
	ENGINE	MODELS	FROM / TO	
CA-356-ML1	V8 SOHC 16V TRITON	AUTOS Y CAMIONES MLS 4 CAPAS, F-150, F250, LOBO. (IZQUIERDA)	1991/2007	
<b>5.4L</b>	MOTOR	MODELOS	DESDE / A	
	ENGINE	MODELS	FROM / TO	
CA-357-ML1	V8 SOHC 16V TRITON	AUTOS Y CAMIONES MLS 4 CAPAS, F-150, F250, LOBO. (DERECHA)	1991/2007	



<b>5.4L</b>	MOTOR	MODELOS	DESDE / A			
	ENGINE	MODELS	FROM / TO			
CA-356-ML	V8 SOHC 16V TRITON	F-250, F-150, LOBO , G, MARQUIS. (IZQUIERDA)	1991/2007			
<b>5.4L</b>	MOTOR	MODELOS	DESDE / A			
	ENGINE	MODELS	FROM / TO			
CA-357-ML	V8 SOHC 16V TRITON	F-250, F-150, LOBO , G, MARQUIS. (IZQUIERDA)	1991/2007			
<b>5.4L</b>	MOTOR	MODELOS	DESDE / A			
	ENGINE	MODELS	FROM / TO			
CA-356-G	V8 SOHC 16V TRITON	F-150, F250, LOBO. (DERECHA)	1991/2009			
<b>5.4L</b>	MOTOR	MODELOS	DESDE / A			
	ENGINE	MODELS	FROM / TO			
CA-357-G	V8 SOHC 16V TRITON	F-150, F250, LOBO. (DERECHA)	1991/2009			
<b>5.4L</b>	MOTOR	MODELOS	DESDE / A			
	ENGINE	MODELS	FROM / TO			
CA-356-1G	V8 SOHC 24V TRITON VIN V,5,	EXPEDITION , LOBO, F-150, F-250 NAVIGATOR. (IZQUIERDA)	2004/2010			
<b>5.4L</b>	MOTOR	MODELOS	DESDE / A			
	ENGINE	MODELS	FROM / TO			
CA-357-1G	V8 SOHC 24V TRITON VIN V,5,	EXPEDITION , LOBO, F-150, F-250 NAVIGATOR. (DERECHA)	2004/2010			
<b>5.8L</b>	MOTOR	MODELOS	DESDE / A			
	ENGINE	MODELS	FROM / TO			
CA-365-G	V8 OHV 16V (351W)	TRUCKS, GALAXIE, GRAND MARQUIS.	1969/1983			
<b>5.8L</b>	MOTOR	MODELOS	DESDE / A			
	ENGINE	MODELS	FROM / TO			
CA-370-G	V8 OHV 16V (351C,400) CARB.	F-150, PICK-UP, TRUCKS.	1970/1982			



<b>6.1L</b>	MOTOR	MODELOS	DESDE / A	
	ENGINE	MODELS	FROM / TO	
CA-380-G	V8 OHV 16V (370,389 CID)	CAMIONES.	1979/1989	
<b>6.8L</b>	MOTOR	MODELOS	DESDE / A	
	ENGINE	MODELS	FROM / TO	
CA-390-ML	V10 OHV 16V TRITON (415CID)	TRUCKS, F-450 SUPER DUTY, EXCURSION. (IZQUIERDA)	1997/2003	
<b>6.8L</b>	MOTOR	MODELOS	DESDE / A	
	ENGINE	MODELS	FROM / TO	
CA-391-ML	V10 SOHC 20V TRITON	ECONOLINE, SUPER DUTY, F-450. (DERECHA)	1997/2003	
<b>6.8L</b>	MOTOR	MODELOS	DESDE / A	
	ENGINE	MODELS	FROM / TO	
CA-390-G	V10 OHV 16V TRITON (415CID)	TRUCKS, F-450 SUPER DUTY. (IZQUIERDA)	1997/1999	
<b>6.8L</b>	MOTOR	MODELOS	DESDE / A	
	ENGINE	MODELS	FROM / TO	
CA-391-G	V10 SOHC 20V TRITON	F-450, SUPER DUTY. (DERECHA)	1999/2007	
<b>7.0L</b>	MOTOR	MODELOS	DESDE / A	
	ENGINE	MODELS	FROM / TO	
CA-375-G	V8 OHV 16V (429,460)	GALAXIE, CUSTOM 500, F-350, F-600.	1968/1985	
<b>7.3L</b>	MOTOR	MODELOS	DESDE / A	
	ENGINE	MODELS	FROM / TO	
CA-376-G	V8 OHV 16V (INTERNATIONAL)	F SUPER DUTY, F-250-E250-E-350	1988/1995	
<b>7.3L</b>	MOTOR	MODELOS	DESDE / A	
	ENGINE	MODELS	FROM / TO	
CA-396-1G	V8 OHV DIESEL INTERNACIONAL	E-250, E-350, ECONOLINE.	1994-2003	



7.5L	MOTOR	MODELOS	DESDE / A	
	ENGINE	MODELS	FROM / TO	
CA-375-G	V8 OHV 16V (427,460)	GALAXIE, CUSTOM 500, F-350, F-700.	1968/1985	





1.0L	MOTOR	MODELOS	DESDE / A	
	ENGINE	MODELS	FROM / TO	
CA-95-G	3L SOHC 6V 61" SA310	SPRINT, FIREFLY, FORSA.	1985/1988	
1.0L	MOTOR	MODELOS	DESDE / A	
	ENGINE	MODELS	FROM / TO	
CA-95-1G	3L SOHC 6v 61"	GEO METRO, SWIFT.	1989/1997	
1.0L	MOTOR	MODELOS	DESDE / A	
	ENGINE	MODELS	FROM / TO	
CA-116-G	4L SOHC 8V DAEWOO ENGINE	MATIZ G2.	2004/2010	
1.2L	MOTOR	MODELOS	DESDE / A	
	ENGINE	MODELS	FROM / TO	
CA-119-ML	4L DOHC 16V	SPARK.	2011/2013	
1.4L	MOTOR	MODELOS	DESDE / A	
	ENGINE	MODELS	FROM / TO	
CA-100-G	4L SOHC 8V	CHEVY POP, JOY, SWING.	1994/2001	
1.4L	MOTOR	MODELOS	DESDE / A	
	ENGINE	MODELS	FROM / TO	
CA-101-G	4L SOHC 8V VIN I	PONTIAC ACADIAN, T1000, CHEVETTE.	1976/1987	
1.6L	MOTOR	MODELOS	DESDE / A	
	ENGINE	MODELS	FROM / TO	
CA-100-1G	4L SOHC 8V	CHEVY MONZA, PICK-UP.	1996/2010	
1.6L	MOTOR	MODELOS	DESDE / A	
	ENGINE	MODELS	FROM / TO	
CA-101-G	4L SOHC 8V VIN I	PONTIAC ACADIAN, T1000, CHEVETTE.	1976/1987	



1.6L	MOTOR	MODELOS	DESDE / A	
	ENGINE	MODELS	FROM / TO	
CA-102-1G	4L DOHC 16V VIN 6 E-TEC	AVEO, PONTIAC G3 (CABEZA DE GRAFITO).	2008/2012	
1.6L	MOTOR	MODELOS	DESDE / A	
	ENGINE	MODELS	FROM / TO	
CA-102-1ML	4L DOHC 16V VIN 6 E-TEC	AVEO, PONTIAC G3 (CABEZA DE MLS).	2008/2012	
1.6L	MOTOR	MODELOS	DESDE / A	
	ENGINE	MODELS	FROM / TO	
CA-103-G	4L SOHC 8V 98" VIN 4	CHEVY NOVA.	1986/1988	
1.6L	MOTOR	MODELOS	DESDE / A	
	ENGINE	MODELS	FROM / TO	
CA-402-G	4L SOHC 8V (USA)	TRACKER, SIDEKICK, SWIFT.	1989/2002	
1.8L	MOTOR	MODELOS	DESDE / A	
	ENGINE	MODELS	FROM / TO	
CA-102-G	4L SOHC 8V MOTOR G180Z G200Z	S10, PICK-UP, BLAZER, TROOPER.	1972/1982	
1.8L	MOTOR	MODELOS	DESDE / A	
	ENGINE	MODELS	FROM / TO	
CA-104-G	4L SOHC 8V PRIMER DISEÑO	CAVALIER, FIRENZA, SKYHAWK, SUNBIRD.	1982	
1.8L	MOTOR	MODELOS	DESDE / A	
	ENGINE	MODELS	FROM / TO	
CA-107-G	4L SOHC 8V 112" VIN J	SUNBIRD, FIRENZA, J2000.	1982/1986	
1.8L	MOTOR	MODELOS	DESDE / A	
	ENGINE	MODELS	FROM / TO	
CA-114-G	4L DOHC 16V 110" MOTOR X18XE1	ASTRA, ZAFIRA, (CABEZA DE GRAFITO).	2000/2008	



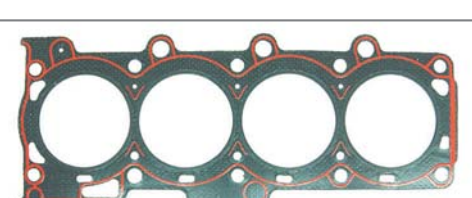

1.8L	MOTOR	MODELOS	DESDE / A	
	ENGINE	MODELS	FROM / TO	
CA-114-ML	4L DOHC 16V X18XE1	ASTRA HATCHBACK (CABEZA DE MLS).	2000/2008	
1.8L	MOTOR	MODELOS	DESDE / A	
	ENGINE	MODELS	FROM / TO	
CA-118-G	4L SOHC 8V	CORSA, PICK-UP TORNADO.	2003/2006	
1.8L	MOTOR	MODELOS	DESDE / A	
	ENGINE	MODELS	FROM / TO	
CA-122-ML	4L DOHC 16V	CRUZE, SONIC. (CABEZA DE MLS).	2011/2013	
1.8L	MOTOR	MODELOS	DESDE / A	
	ENGINE	MODELS	FROM / TO	
CA-122-G	4L DOHC 16V MOTOR ECOTEC LUW	CRUZE, SONIC. (CABEZA DE GRAFITO).	2011/2013	
1.9L	MOTOR	MODELOS	DESDE / A	
	ENGINE	MODELS	FROM / TO	
CA-102-G	4L SOHC 8V MOTOR G180Z G200Z	S10, PICK-UP, BLAZER, TROOPER.	1982/1985	
1.9L	MOTOR	MODELOS	DESDE / A	
	ENGINE	MODELS	FROM / TO	
CA-111-G	4L SOHC 8V 116" MFI VIN 8 9	SATURN.	1991/2002	
1.9L	MOTOR	MODELOS	DESDE / A	
	ENGINE	MODELS	FROM / TO	
CA-115-G	4L DOHC 16V 116"	SATURN SC2, SL2, SC, SL2.	1991/1995	
2.0L	MOTOR	MODELOS	DESDE / A	
	ENGINE	MODELS	FROM / TO	
CA-104-G	4L SOHC 8V PRIMER DISEÑO	CAVALIER, FIRENZA, SKYHAWK, SUNBIRD.	1983/1987	



2.0L	MOTOR	MODELOS	DESDE / A	
	ENGINE	MODELS	FROM / TO	
CA-107-G	4L SOHC 8V 122"	J2000, SUNBIRD.	1982/1986	
2.0L	MOTOR	MODELOS	DESDE / A	
	ENGINE	MODELS	FROM / TO	
CA-108-G	4L OHV 8V 122"	CAVALIER USA, PICK-UP S10, BLAZER, BERETTA, CORSICA.	1987/1989	
2.0L	MOTOR	MODELOS	DESDE / A	
	ENGINE	MODELS	FROM / TO	
CA-117-ML	4L DOHC 16V	OPTRA, ASTRA, FORENZA.	2004/2010	
2.0L	MOTOR	MODELOS	DESDE / A	
	ENGINE	MODELS	FROM / TO	
CA-117-G	4L SOHC/DOHC 8V;16V	ASTRA, OPTRA.	2004/2008	
2.0L	MOTOR	MODELOS	DESDE / A	
	ENGINE	MODELS	FROM / TO	
CA-133-ML	4L DOHC 16V	TRACKER, VITARA (CABEZA DE MLS).	1999/2003	
2.2L	MOTOR	MODELOS	DESDE / A	
	ENGINE	MODELS	FROM / TO	
CA-108-G	4L OHV 8V 134"	CAVALIER USA, PICK-UP S10, BLAZER, BERETTA, CORSICA.	1990/1991	
2.2L	MOTOR	MODELOS	DESDE / A	
	ENGINE	MODELS	FROM / TO	
CA-112-G	4L OHV 8V 134"	S-10, BLAZER, SONOMA, ISUZU HOMBRE.	1994/1997	
2.2L	MOTOR	MODELOS	DESDE / A	
	ENGINE	MODELS	FROM / TO	
CA-113-G	4L DOHC 16V ECOTEC	ASTRA, ZAFIRA, SUNFIRE, CAVALIER, HHR (CABEZA DE GRAFITO).	2001/2008	



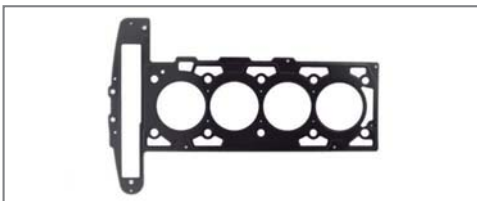
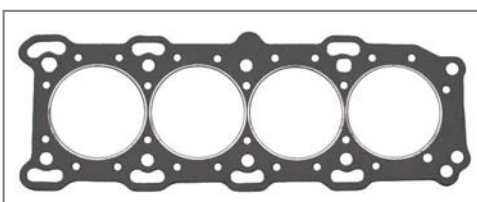
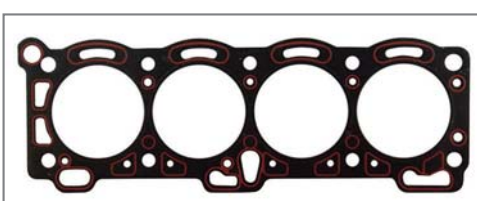

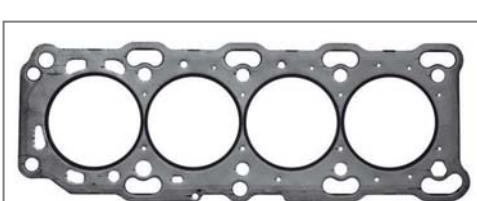
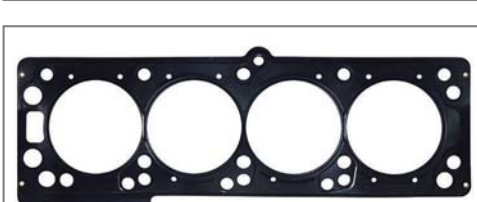
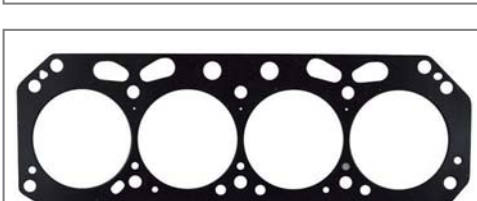
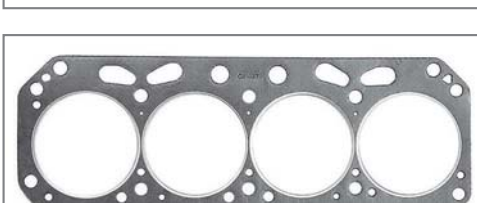





2.2L	MOTOR	MODELOS	DESDE / A	
	ENGINE	MODELS	FROM / TO	
CA-113-ML	4L DOHC 16V ECOTEC	ASTRA, ZAFIRA, SUNFIRE, CAVALIER, HHR (CABEZA DE MLS).	2001/2008	
2.3L	MOTOR	MODELOS	DESDE / A	
	ENGINE	MODELS	FROM / TO	
CA-109-G	4L DOHC 16V QUAD4 VIN A 3	PONTIAC SUNFIRE, CUTLASS, BERETTA, GRAND AM, GRAND PRIX, CALAIS, SKYLARK.	1987/1991	
2.3L	MOTOR	MODELOS	DESDE / A	
	ENGINE	MODELS	FROM / TO	
CA-1710-G	4L SOHC 8V MOTOR 4ZD1 VIN L	AMIGO, TROOPER, IMPULSE, PICK UP. LUV.	1997/1998	
2.4L	MOTOR	MODELOS	DESDE / A	
	ENGINE	MODELS	FROM / TO	
CA-109-1G	4L DOHC 16V QUAD4 VIN T	PONTIAC SUNFIRE, GRAND AM, CAVALIER.	1997/2002	
2.4L	MOTOR	MODELOS	DESDE / A	
	ENGINE	MODELS	FROM / TO	
CA-109-2G	4L DOHC 16V QUAD4 VIN T MOTOR LD9	ALERO, CAVALIER, MALIBU, PONTIAC GRAND AM, SUNFIRE.	1999/2002	
2.4L	MOTOR	MODELOS	DESDE / A	
	ENGINE	MODELS	FROM / TO	
CA-117-ML	4L DOHC 16V	PONTIAC G4, ASTRA.	2004/2006	
2.5L	MOTOR	MODELOS	DESDE / A	
	ENGINE	MODELS	FROM / TO	
CA-105-G	4L OHV 8V 151" VIN 2 R	PONTIAC SPIRIT USA, AMX MEXICO, CAMARO, CELEBRITY, CITATION, CJ5, CJ7.	1979/1983	
2.5L	MOTOR	MODELOS	DESDE / A	
	ENGINE	MODELS	FROM / TO	
CA-106-G	4L OHV 8V 151" VIN R 2	CENTURY, SKYLARK, GRAND AM.	1985/1986	

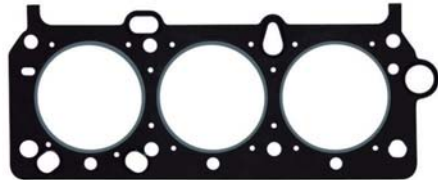

<b>2.7L</b>	MOTOR	MODELOS	DESDE / A		
	ENGINE	MODELS	FROM / TO		
CA-123-G	V6 DOHC 24V H27A	VITARA, GRAND VITARA.	2006/2010		
<b>2.7L</b>	MOTOR	MODELOS	DESDE / A		
	ENGINE	MODELS	FROM / TO		
CA-123-1G	V6 DOHC 24V H27A	VITARA, GRAND VITARA.	2006/2010		
<b>2.8L</b>	MOTOR	MODELOS	DESDE / A		
	ENGINE	MODELS	FROM / TO		
CA-126-ML	4L DOHC 16V VIN "8" MOTOR LK5	COLORADO	2004/2006.		
<b>2.8L</b>	MOTOR	MODELOS	DESDE / A		
	ENGINE	MODELS	FROM / TO		
CA-140-G	V6 OHV 12V 173" VIN B X Z 1 7	CITATION, CELEBRITY, CENTURY, CAMARO, JEEP, EAGLE (USA), PONTIAC FIERO,CAMION.	1980/1995		
<b>2.8L</b>	MOTOR	MODELOS	DESDE / A		
	ENGINE	MODELS	FROM / TO		
CA-141-G	V6 OHV 12V	MPFI 2a GENERACION, CAVALIER, CUTLASS, EUROSPORT, CENTURY.	1988/1994		
<b>2.9L</b>	MOTOR	MODELOS	DESDE / A		
	ENGINE	MODELS	FROM / TO		
CA-127-ML	DOHC 16V	COLORADO PICK-UP.	2007/2009		
<b>3.1L</b>	MOTOR	MODELOS	DESDE / A		
	ENGINE	MODELS	FROM / TO		
CA-141-G	V6 OHV 12V VIN T	CAVALIER, GRAND AM, CUTLASS.	1988/2001		
<b>3.1L</b>	MOTOR	MODELOS	DESDE / A		
	ENGINE	MODELS	FROM / TO		
CA-145-G	V6 OHV 12V VIN "J"	CUTLASS, BERETTA, MONTE CARLO, LUMINA.	1993/2007		







3.3L	MOTOR	MODELOS	DESDE / A	
	ENGINE	MODELS	FROM / TO	
CA-146-G	V6 OHV 12V 189" VIN N L	PONTIAC GRAND AM, BUICK CENTURY, OLDSMOBILE CUTLAS CIERA, PONTIAC BONNEVILLE, BUICK LESABRE, REGAL, RIVERA, CHEVROLET LUMINA APV.	1990/1991	
3.4L	MOTOR	MODELOS	DESDE / A	
	ENGINE	MODELS	FROM / TO	
CA-172-G	V6 DOHC 24V 207"	MONTE CARLO, OLDSMOBILE CUTLASS SUPREME, PONTIAC GRAND PRIX.	1991/1995	
3.4L	MOTOR	MODELOS	DESDE / A	
	ENGINE	MODELS	FROM / TO	
CA-173-G	V6 OHV 12V VIN "E""S"	VENTURE, GRAND AM, IMPALA.	1996/2003	
3.5L	MOTOR	MODELOS	DESDE / A	
	ENGINE	MODELS	FROM / TO	
CA-110-S	6L OHV 12V 216"	BEL AIR, FLEETMASTER, TWO-TEN SERIES, AUTOS Y CAMIONES TODOS.	1937/1953	
3.5L	MOTOR	MODELOS	DESDE / A	
	ENGINE	MODELS	FROM / TO	
CA-128-ML	5L DOHC 20 V 211" VIN 6	COLORADO, CANYON, H3, i-350.	2004/2006	
3.5L	MOTOR	MODELOS	DESDE / A	
	ENGINE	MODELS	FROM / TO	
CA-156-G	V6 DOHC 24V VIN H	AURORA, INTRIGUE. (IZQUIERDA)	1999/2002	
3.5L	MOTOR	MODELOS	DESDE / A	
	ENGINE	MODELS	FROM / TO	
CA-156-1G	V6 DOHC 24V VIN H	AURORA, INTRIGUE. (DERECHA)	1999/2002	
3.6L	MOTOR	MODELOS	DESDE / A	
	ENGINE	MODELS	FROM / TO	
CA-183-ML	V6 DOHC 24V 217"	ACADIA, EQUINOX, MALIBU, G6, G8, TORRENT, CADILLAC CTS, SRX Y STS.	2004/2011	



3.6L	MOTOR	MODELOS	DESDE / A	
	ENGINE	MODELS	FROM / TO	
CA-183-1ML	V6 DOHC 24V	EQUINOX, MALIBU, TORRENT.	2008/2010	
3.7L	MOTOR	MODELOS	DESDE / A	
	ENGINE	MODELS	FROM / TO	
CA-129-ML	5L DOHC 20V VIN E	COLORADO, CANYON, ISUZU I-370, HUMMER H3.	2007/2012	
3.8L	MOTOR	MODELOS	DESDE / A	
	ENGINE	MODELS	FROM / TO	
CA-120-S	6L OHV 12V 235"	BEL AIR, AUTOS & CAMIONES.	1953/1962	
3.8L	MOTOR	MODELOS	DESDE / A	
	ENGINE	MODELS	FROM / TO	
CA-142-G	V6 OHV 12V VIN A B C 3 4 6 7 8 9	AUTOS BUICK, CUTLASS, MONTE CARLO, MALIBU.	1977/1982	
3.8L	MOTOR	MODELOS	DESDE / A	
	ENGINE	MODELS	FROM / TO	
CA-143-G	V6 OHV 12V VIN K 9	MALIBU, IMPALA, CAPRICE, PONTIAC LeMANS.	1980/1984	
3.8L	MOTOR	MODELOS	DESDE / A	
	ENGINE	MODELS	FROM / TO	
CA-146-G	V6 OHV 12V VIN L	PONTIAC GRAND AM, BUICK CENTURY, OLDSMOBILE CUTLASS CIERA, PONTIAC BONNEVILLE, BUICK LESABRE, REGAL, RIVERA, CHEVROLET LUMINA APV.	1991/1993	
3.8L	MOTOR	MODELOS	DESDE / A	
	ENGINE	MODELS	FROM / TO	
CA-147-G	V6 OHV 12V 231" VIN C	ELECTRA, LE SABRE, REATTA, RIVERA.	1988/1990	
3.8L	MOTOR	MODELOS	DESDE / A	
	ENGINE	MODELS	FROM / TO	
CA-148-G	V6 OHV 12V 231" VIN K	GRAND PRIX, LeSABRE, MONTE CARLO, LUMINA, REGAL, BONNEVILLE. (IZQUIERDA)	1997/2005	

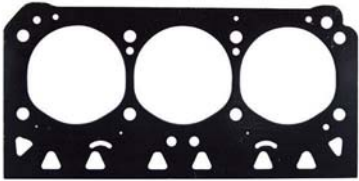
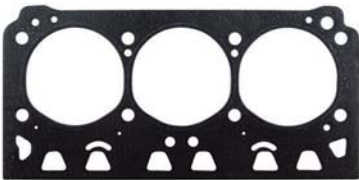
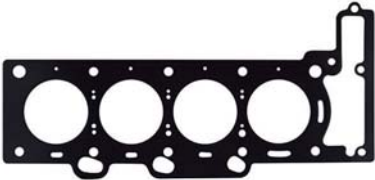
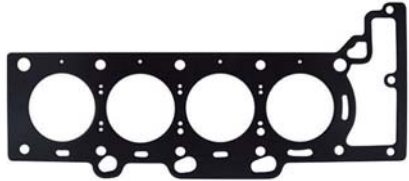
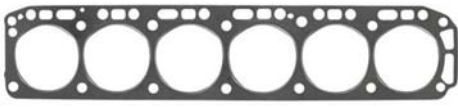



3.8L	MOTOR	MODELOS	DESDE / A	
	ENGINE	MODELS	FROM / TO	
CA-149-G	V6 OHV 12V 231" VIN K	BUICK LE SABRE, REGAL, RIVIERA, PONTIAC GRAND PRIX, LUMINA, MONTE CARLO, IMPALA. (DERECHA)	1995/2005	
3.8L	MOTOR	MODELOS	DESDE / A	
	ENGINE	MODELS	FROM / TO	
CA-149-1G	V6 OHV 12V 231" VIN 1 4 MOTOR L67.	PARK AVENUE, REGAL, RIVIERA, IMPALA, GRAND PRIX (SUPER-CARGADOS).	1997/2005	
4.0L	MOTOR	MODELOS	DESDE / A	
	ENGINE	MODELS	FROM / TO	
CA-139-1G	V8 DOHC 32V 244"	AURORA, OLDSMOBILE ;SHELBY. (DERECHA)	1995/2003	
4.0L	MOTOR	MODELOS	DESDE / A	
	ENGINE	MODELS	FROM / TO	
CA-139-G	V8 DOHC 32V 244"	AURORA, OLDSMOBILE ;SHELBY. (IZQUIERDA)	1995/2003	
4.1L	MOTOR	MODELOS	DESDE / A	
	ENGINE	MODELS	FROM / TO	
CA-130-G	6L OHV 12V	AUTOS Y CAMIONES.	1963/1992	
4.1L	MOTOR	MODELOS	DESDE / A	
	ENGINE	MODELS	FROM / TO	
CA-132-G	6L OHV 12V	SERIES C10, C20, C30, K10, K20.	1979	
4.2L	MOTOR	MODELOS	DESDE / A	
	ENGINE	MODELS	FROM / TO	
CA-153-ML	6L DOHC 24V 256" VIN S	TRAILBLAZER, ENVOY, ASCENDER, BRAVADA (CABEZA DE MLS).	2002/2006	
4.2L	MOTOR	MODELOS	DESDE / A	
	ENGINE	MODELS	FROM / TO	
CA-153-G	6LDOHC 24V 256" MOTOR VORTEC VIN S	TRAILBLAZER, ENVOY, ASCENDER, BRAVADA (CABEZA DE GRAFITO).	2002/2006	



<b>4.3L</b>	MOTOR	MODELOS	DESDE / A	
	ENGINE	MODELS	FROM / TO	
CA-125-B	6L OHV 12V 261"	PICK-UP K10, K20, CAMION.	1954/1962	
<b>4.3L</b>	MOTOR	MODELOS	DESDE / A	
	ENGINE	MODELS	FROM / TO	
CA-144-G	V6 OHV 12V VIN Z	ASTRO, PICKUP S-10, C10, C20, C1500, C2500, SAFARI, CAPRICE, EL CAMINO.	1985/1990	
<b>4.3L</b>	MOTOR	MODELOS	DESDE / A	
	ENGINE	MODELS	FROM / TO	
CA-151-G	V8 V8 OHV 16V 265" MOTOR VORTEC	CAPRICE.	1994/1996	
<b>4.3L</b>	MOTOR	MODELOS	DESDE / A	
	ENGINE	MODELS	FROM / TO	
CA-162-G	V8 OHV 16V VIN 8 F	CUTLASS, BROGHAM, CALAIS, CRUSIER, SALON, DELTA 88, OMEGA.	1977/1982	
<b>4.6L</b>	MOTOR	MODELOS	DESDE / A	
	ENGINE	MODELS	FROM / TO	
CA-174-G	V8 DOHC 32V 279" MOTOR NORTHSTAR VIN A 4 9	CADILLAC DEVILLE, ELDORADO, SEVILLE, PONTIAC BONEVILLE. (DERECHA)	2000/2001	
<b>4.6L</b>	MOTOR	MODELOS	DESDE / A	
	ENGINE	MODELS	FROM / TO	
CA-174-1G	V8 DOHC 32V 279" MOTOR NORTHSTAR VIN A 4 9	CADILLAC DEVILLE, ELDORADO, SEVILLE, PONTIAC BONEVILLE. (IZQUIERDA)	2000/2001	
<b>4.8L</b>	MOTOR	MODELOS	DESDE / A	
	ENGINE	MODELS	FROM / TO	
CA-130-G	6L OHV 12V	AUTOS Y CAMIONES.	1963/1992	
<b>4.8L</b>	MOTOR	MODELOS	DESDE / A	
	ENGINE	MODELS	FROM / TO	
CA-175-G	V8 SOHC 16V VORTEC VIN VT	CHEYENNE, SILVERADO 1500, 2500, SUBURBAN, YUKON, SIERRA 1500, 2500, TAHOE (CABEZAS DE GRAFITO).	1999/2001	





4.8L	MOTOR	MODELOS	DESDE / A	
	ENGINE	MODELS	FROM / TO	
CA-175-ML	V8 OHV 16V VIN B M P T V	CHEYENNE, SILVERADO 1500, 2500, SUBURBAN, YUKON, SIERRA 1500, 2500, TAHOE (CABEZAS DE MLS).	1999/2001	
4.9L	MOTOR	MODELOS	DESDE / A	
	ENGINE	MODELS	FROM / TO	
CA-170-B	V8 OHV 16V 301"	BUICK, ELECTRA, LESABRE, SKYLARK, PONTIAC LEMANS, VENTURA.	1977/1981	
5.0L	MOTOR	MODELOS	DESDE / A	
	ENGINE	MODELS	FROM / TO	
CA-160-G	V8 OHV 16V 305"	AUTOS Y CAMIONES.	1976/1980	
5.0L	MOTOR	MODELOS	DESDE / A	
	ENGINE	MODELS	FROM / TO	
CA-163-T	V8 OHV 16V MOTOR OLDSMOBILE 307"	BUICK, CADILLAC, CHEVROLET, OLDSMOBILE.	1980/1984	
5.3L	MOTOR	MODELOS	DESDE / A	
	ENGINE	MODELS	FROM / TO	
CA-175-ML	V8 OHV 16V VIN B M P T V	CHEYENNE, SILVERADO 1500, 2500, SUBURBAN, YUKON, SIERRA 1500, 2500, TAHOE (CABEZAS DE MLS).	1999/2001	
5.3L	MOTOR	MODELOS	DESDE / A	
	ENGINE	MODELS	FROM / TO	
CA-175-G	V8 SOHC 16V VORTEC VIN V T	CHEYENNE, SILVERADO 1500, 2500, SUBURBAN, YUKON, SIERRA 1500, 2500, TAHOE (CABEZAS DE GRAFITO).	1999/2001	
5.7L	MOTOR	MODELOS	DESDE / A	
	ENGINE	MODELS	FROM / TO	
CA-150-G	V8 OHV 16V VORTEC MEXICO TBI	MICROBUS, SUBURBAN, C-2500, C-3500, PICK-UP SOLO MEXICO.	1992/1998	
5.7L	MOTOR	MODELOS	DESDE / A	
	ENGINE	MODELS	FROM / TO	
CA-151-1G	V8 OHV 16V VIN P LT1	FIREBIRD, CAMARO Z28, CAPRICE.	1992/1997	



5.7L	MOTOR	MODELOS	DESDE / A	
	ENGINE	MODELS	FROM / TO	
CA-164-G	V8 OHV 16V 350"	APOLLO, OMEGA, CENTURY, ELECTRA, LE SABRE, OLDSMOBILE, BUICK.	1968/1980	
5.7L	MOTOR	MODELOS	DESDE / A	
	ENGINE	MODELS	FROM / TO	
CA-165-T	V8 OHV 16V 350" VIN R	CADILLAC SEVILLE.	1976	
6.0L	MOTOR	MODELOS	DESDE / A	
	ENGINE	MODELS	FROM / TO	
CA-176-G	V8 SOHC 16V VORTEC VIN U	SILVERADO 2500, SIERRA 2500, YUKON, EXPRESS VAN, CARGO VAN, SUBURBAN (CABEZA DE GRAFITO).	1999/2000	
6.0L	MOTOR	MODELOS	DESDE / A	
	ENGINE	MODELS	FROM / TO	
CA-176-ML	V8 SOHC 16V VORTEC VIN U	SILVERADO 2500, SIERRA 2500, YUKON, EXPRESS VAN, CARGO VAN, SUBURBAN (CABEZAS DE MLS).	1999/2000	
6.2L	MOTOR	MODELOS	DESDE / A	
	ENGINE	MODELS	FROM / TO	
CA-179-G	V8 OHV 16V VIN C X J	SUBURBAN 1500, 2500, 3500, PICK UP K1500, 2500, 3500, C1500, C2500, C3500, HUMMER.	1982/1993	
6.5L	MOTOR	MODELOS	DESDE / A	
	ENGINE	MODELS	FROM / TO	
CA-180-GD	V8 OHV 16V VIN F P S Y Z	PICK UP C1500, C2500, C3500, K1500, K2500, K3500, EXPRESS 2500, 3500, SAVANA, YUKON, TAHOE, HUMMER H1.	1994/2005	
6.6L	MOTOR	MODELOS	DESDE / A	
	ENGINE	MODELS	FROM / TO	
CA-155-G	V8 OHV 16V "401" BLOCK CHICO	MONTE CARLO, IMPALA, CHEVLE NOMAD, CAPRICE, BEL AIR, CAMARO, EL CAMINO, PONTIAC FIREBIRD, BONNEVILLE.	1970/1976	
7.0L	MOTOR	MODELOS	DESDE / A	
	ENGINE	MODELS	FROM / TO	
CA-167-G	V8 OHV 16V 427"	CAMARO, CORVETTE, CAPRICE, IMPALA.	1965/1969	



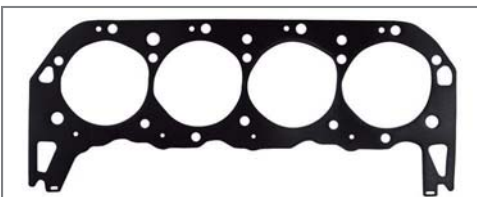
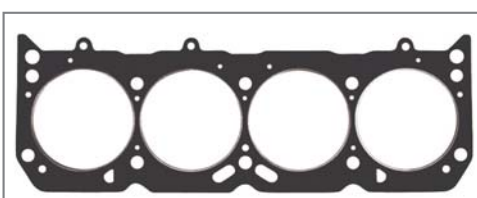
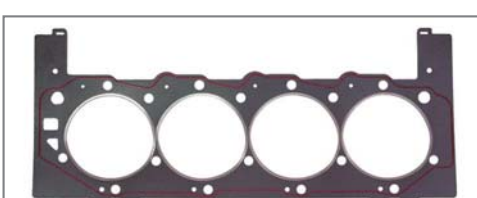

<b>7.4L</b>	MOTOR	MODELOS	DESDE / A	
	ENGINE	MODELS	FROM / TO	
CA-167-G	V8 OHV 16V 454"	AUTOS Y CAMIONES.	1970/1980	
<b>7.4L</b>	MOTOR	MODELOS	DESDE / A	
	ENGINE	MODELS	FROM / TO	
CA-168-G	V8 OHV 16V 454"	PICK UP C1500, C2500, C3500.	1980/1985	
	MOTOR	MODELOS	DESDE / A	
	ENGINE	MODELS	FROM / TO	
CA-169-G	V8 OHV 16V 454" VORTEC VIN C	KODIAK C2500, C3500, K2500, K3500.	1996/2000	
<b>7.5L</b>	MOTOR	MODELOS	DESDE / A	
	ENGINE	MODELS	FROM / TO	
CA-165-T	V8 OHV 16V 455" VIN R	OLDSMOBILE DELTA, CUTLASS, VISTA.	1968/1974	
<b>8.1L</b>	MOTOR	MODELOS	DESDE / A	
	ENGINE	MODELS	FROM / TO	
CA-181-G	V8 OHV 16V	SILVERADO, 2500HD, 3500, SIERRA 2500, 3500, YUKON, SUBURBAN, AVALANCHE, EXPRESS VAN.	2001/2007	



1.3L	MOTOR	MODELOS	DESDE / A	
	ENGINE	MODELS	FROM / TO	
CA-1450-G	4L SOHC 8V D13A1 D13A2 EV1 EV2	CIVIC.	1984/1987	
1.5L	MOTOR	MODELOS	DESDE / A	
	ENGINE	MODELS	FROM / TO	
CA-1450-G	4L SOHC 12V D15A3 EW3 EW4	CIVIC.	1984/1991	
1.5L	MOTOR	MODELOS	DESDE / A	
	ENGINE	MODELS	FROM / TO	
CA-1452-G	4L SOHC 16V D15B7, D15B8.	CIVIC (CABEZA DE GRAFITO).	1988/1995	
1.6L	MOTOR	MODELOS	DESDE / A	
	ENGINE	MODELS	FROM / TO	
CA-1454-G	4L DOHC 16V MOTOR VTE-CB181.	CIVIC DEL SOL.	1994/2000	
1.6L	MOTOR	MODELOS	DESDE / A	
	ENGINE	MODELS	FROM / TO	
CA-1455-ML	4L SOHC 16V MOTOR VTEC D16Y5, D16Y7, D16Y8.	CIVIC , ACURA EL (CABEZA DE MLS).	1996/2000	
1.6L	MOTOR	MODELOS	DESDE / A	
	ENGINE	MODELS	FROM / TO	
CA-1455-G	4L SOHC 16V D16B5 D16Y7 D16Y8 D16Z6	CIVIC. ACURA EL (CABEZA DE GRAFITO).	1996/2000	
1.7L	MOTOR	MODELOS	DESDE / A	
	ENGINE	MODELS	FROM / TO	
CA-1459-G	4L SOHC 16V D17A1, A2, A6, A7.	CIVIC, ACURA EL.	2001/2005	
1.7L	MOTOR	MODELOS	DESDE / A	
	ENGINE	MODELS	FROM / TO	
CA-1459-ML	4L SOHC 16V D17A1, A2, A6, A7.	CIVIC, ACURA EL.	2001/2005	







1.8L	MOTOR	MODELOS	DESDE / A	
	ENGINE	MODELS	FROM / TO	
CA-1454-G	1994/2001 4L DOHC 16V MOTOR VTECB18C1.	ACURA INTEGRA.	1994/2001	
1.8L	MOTOR	MODELOS	DESDE / A	
	ENGINE	MODELS	FROM / TO	
CA-1480-ML	4L SOHC 16V MOTOR i-VTE-CR18A1, A4.	CIVIC EX, DX, LXS.	2006/2009	
2.0L	MOTOR	MODELOS	DESDE / A	
	ENGINE	MODELS	FROM / TO	
CA-1453-G	4L SOHC 12V A20A1, A20A2, A20A3.	ACCORD, PRELUDE.	1985/1989	
2.0L	MOTOR	MODELOS	DESDE / A	
	ENGINE	MODELS	FROM / TO	
CA-1461-ML	4L DOHC 16V B20B4, B20Z2.	CR-V.	1997/2001	
2.2L	MOTOR	MODELOS	DESDE / A	
	ENGINE	MODELS	FROM / TO	
CA-1457-ML	4L SOHC 16V F22A4, F22A6, F22A1.	ACCORD.	1990/1991	
2.2L	MOTOR	MODELOS	DESDE / A	
	ENGINE	MODELS	FROM / TO	
CA-1457-G	4L SOHC 16V F22A4, F22A6, F22A1.	ACCORD, PRELUDE.	1990/1997	
2.3L	MOTOR	MODELOS	DESDE / A	
	ENGINE	MODELS	FROM / TO	
CA-1463-ML	4L SOHC 16V MOTOR VTEC-F23A1, A4, A5, A7.	ACCORD, ODYSSEY, ACURA CL.	1998/2002	
2.3L	MOTOR	MODELOS	DESDE / A	
	ENGINE	MODELS	FROM / TO	
CA-1473-ML	4L DOHC 16V H23A1	PRELUDE.	1992/1996	



<b>2.4L</b>	MOTOR	MODELOS	DESDE / A	
	ENGINE	MODELS	FROM / TO	
CA-1466-ML	4L DOHC 16V K24A1	CR-V.	2002/2006	
<b>2.4L</b>	MOTOR	MODELOS	DESDE / A	
	ENGINE	MODELS	FROM / TO	
CA-1469-ML	4L DOHC 16V i-VTEC K24Z1, K24A8, K24Z6.	CR-V, ACCORD, ELEMENT, ACURA TSX.	2004/2010	
<b>2.7L</b>	MOTOR	MODELOS	DESDE / A	
	ENGINE	MODELS	FROM / TO	
CA-1465-G	V6 SOHC 24V MOTOR C27A4.	ACCORD.	1995/1997	
<b>3.0L</b>	MOTOR	MODELOS	DESDE / A	
	ENGINE	MODELS	FROM / TO	
CA-1467-ML	V6 SOHC 24V MOTOR VTEC-J30A1.	ACCORD , ACURA CL.	1997/2002	
<b>3.2L</b>	MOTOR	MODELOS	DESDE / A	
	ENGINE	MODELS	FROM / TO	
CA-1470-G	V6 SOHC 24V MOTOR VTE-C32A1, A6.	ACURA LEGEND, TL.	1991/1998	
<b>3.2L</b>	MOTOR	MODELOS	DESDE / A	
	ENGINE	MODELS	FROM / TO	
CA-1471-ML	V6 SOHC 24V MOTOR VTEC-J32A1.	ACURA CL, TL.	1999/2003	
<b>3.2L</b>	MOTOR	MODELOS	DESDE / A	
	ENGINE	MODELS	FROM / TO	
CA-1471-1ML	V6 SOHC 24V	ACURA TL.	2004/2008	
<b>3.5L</b>	MOTOR	MODELOS	DESDE / A	
	ENGINE	MODELS	FROM / TO	
CA-1470-G	V6 SOHC 24V MOTOR VTE-C35A1.	ACURA RL. (IZQUIERDA)	1996/2004	





3.5L	MOTOR	MODELOS	DESDE / A	
	ENGINE	MODELS	FROM / TO	
CA-1470-1G	V6 SOHC 24V MOTOR VTE-C35A1.	ACURA RL. (DERECHA)	1996/2004	
3.5L	MOTOR	MODELOS	DESDE / A	
	ENGINE	MODELS	FROM / TO	
CA-1471-ML	V6 SOHC 24V	ODYSSEY, PILOT, ACURA MDX.	1999/2004	
3.5L	MOTOR	MODELOS	DESDE / A	
	ENGINE	MODELS	FROM / TO	
CA-1471-1ML	V6 SOHC 24V MOTOR VTEC-J35A6, A7, A9, Z1.	PILOT, ODYSSEY, RIDGELINE, ACURA MDX, SATURN VUE.	2003/2010	
3.5L	MOTOR	MODELOS	DESDE / A	
	ENGINE	MODELS	FROM / TO	
CA-1476-ML	V6 SOHC 24V MOTOR J35Z2, Z3, Z4, Z5.	ACCORD, ACCORD CROSSTOUR, PILOT, RIDGELINE, ODYSSEY, ACURA RDX, TSX, TL. (DERECHA)	2008/2013	
3.5L	MOTOR	MODELOS	DESDE / A	
	ENGINE	MODELS	FROM / TO	
CA-1476-1ML	V6 SOHC 24V MOTOR J35Z2, Z3, Z4, Z5.	ACCORD, ACCORD CROSSTOUR, PILOT, RIDGELINE, ODYSSEY, ACURA RDX, TSX, TL. (IZQUIERDA)	2008/2013	



<b>2.6L</b>	MOTOR	MODELOS	DESDE / A	
	ENGINE	MODELS	FROM / TO	
CA-1720-G	4L SOHC 8V 4ZE1 VIN E.	RODEO, TROOPER, AMIGO.	1988/1997	
<b>3.2L</b>	MOTOR	MODELOS	DESDE / A	
	ENGINE	MODELS	FROM / TO	
CA-1750-G	V6 SOHC 24V VIN V	RODEO, TROOPER, HONDA PASSPORT.	1992/1995	
<b>3.2L</b>	MOTOR	MODELOS	DESDE / A	
	ENGINE	MODELS	FROM / TO	
CA-1752-ML	V6 SOHC 32V 6VD1	RODEO, AMIGO, TROOPER, AXIOM, VehiCROSS, HONDA PASSPORT. (IZQUIERDA)	1998/2003	
<b>3.2L</b>	MOTOR	MODELOS	DESDE / A	
	ENGINE	MODELS	FROM / TO	
CA-1752-1ML	V6 SOHC 32V 6VD1	RODEO, AMIGO, TROOPER, AXIOM, VehiCROSS, HONDA PASSPORT. (DERECHA)	1998/2003	
<b>3.5L</b>	MOTOR	MODELOS	DESDE / A	
	ENGINE	MODELS	FROM / TO	
CA-1752-1ML	V6 SOHC 32V 6VE1	RODEO, AMIGO, TROOPER, AXIOM, VehiCROSS, HONDA PASSPORT. (DERECHA)	1998/2003	
<b>3.5L</b>	MOTOR	MODELOS	DESDE / A	
	ENGINE	MODELS	FROM / TO	
CA-1752-ML	V6 SOHC 32V 6VE1	RODEO, AMIGO, TROOPER, AXIOM, VehiCROSS, HONDA PASSPORT. (IZQUIERDA)	1998/2003	



1.6L	MOTOR	MODELOS	DESDE / A	
	ENGINE	MODELS	FROM / TO	
CA-324-ML	4L DOHC 16V Z6	MAZDA 3.	2006/2007	
1.6L	MOTOR	MODELOS	DESDE / A	
	ENGINE	MODELS	FROM / TO	
CA-1107-G	4L SOHC 8V y DOHC 16V TURBOCARGADO	MIATA, CAPRI, 323, MX-5.	1988/1994	
1.8L	MOTOR	MODELOS	DESDE / A	
	ENGINE	MODELS	FROM / TO	
CA-1111-2ML	4L DOHC 16V	MIATA.	2001/2005	
2.0L	MOTOR	MODELOS	DESDE / A	
	ENGINE	MODELS	FROM / TO	
CA-1110-G	4L SOHC 8V MOTOR "FE" y "F8"	PICK UP B2000, 626.	1983/1987	
2.0L	MOTOR	MODELOS	DESDE / A	
	ENGINE	MODELS	FROM / TO	
CA-1112-ML	4L DOHC 16V	626 , PROTEGE, PROBE, MX-6.	1993/1997	
2.2L	MOTOR	MODELOS	DESDE / A	
	ENGINE	MODELS	FROM / TO	
CA-1120-G	4L SOHC 12V MOTOR F2	626, MX-6, FORD PROBE.	1988/1992	
2.5L	MOTOR	MODELOS	DESDE / A	
	ENGINE	MODELS	FROM / TO	
CA-328-1ML	V6 DOHC 24V DURATEC VIN G,L	COUGAR, MAZDA MPV. (IZQUIERDA)	2001/2002	
2.5L	MOTOR	MODELOS	DESDE / A	
	ENGINE	MODELS	FROM / TO	
CA-328-ML	V6 DOHC 24V DURATEC VIN G,L	COUGAR, MAZDA MPV. (DERECHA)	2001/2002	



2.6L	MOTOR	MODELOS	DESDE / A
	ENGINE	MODELS	FROM / TO
CA-1125-G	4L SOHC 12V MOTOR G6	PICK-UP B2600 , MPV.	1989/1994



3.0L	MOTOR	MODELOS	DESDE / A
	ENGINE	MODELS	FROM / TO
CA-1130-ML	V6 DOHC 24V	929, MPV. (DERECHO)	1989/1998











3.0L	MOTOR	MODELOS	DESDE / A
	ENGINE	MODELS	FROM / TO
CA-1131-ML	V6 DOHC 24V	929, MPV. (IZQUIERDO).	1989/1998







1.2L	MOTOR	MODELOS	DESDE / A	
	ENGINE	MODELS	FROM / TO	
CA-1213-G	4L OHV 8V MOTOR A12	AUTOS AMERICANOS.	1980/1982	
1.4L	MOTOR	MODELOS	DESDE / A	
	ENGINE	MODELS	FROM / TO	
CA-1213-G	4L OHV 8V MOTOR A14	AUTOS AMERICANOS.	1979/1982	
1.5L	MOTOR	MODELOS	DESDE / A	
	ENGINE	MODELS	FROM / TO	
CA-1213-G	4L OHV 8V MOTOR A15	AUTOS AMERICANOS.	1979/1982	
1.5L	MOTOR	MODELOS	DESDE / A	
	ENGINE	MODELS	FROM / TO	
CA-1216-G	4L SOHC 8V E15	TSURU I.	1984/1987	
1.6L	MOTOR	MODELOS	DESDE / A	
	ENGINE	MODELS	FROM / TO	
CA-1216-G	4L SOHC 8V E16	TSURU II.	1987/1991	
1.6L	MOTOR	MODELOS	DESDE / A	
	ENGINE	MODELS	FROM / TO	
CA-1226-G	4L DOHC 16V GA16DE MOTOR JAPONES	200S SX, SENTRA , TSURU GS1, TSUBAME, LUCINO.	1991/1996	
1.6L	MOTOR	MODELOS	DESDE / A	
	ENGINE	MODELS	FROM / TO	
CA-1226-1G	4L DOHC 16V GA16DE GA16DNE	TSURU GSI, GSII, SENTRA MEXICO, TSUBAME.	1997/2014	
1.6L	MOTOR	MODELOS	DESDE / A	
	ENGINE	MODELS	FROM / TO	
CA-1227-G	4L SOHC 12 V MOTOR GA16I	SENTRA AMERICANO, PULSAR NX.	1989/1990	



1.6L	MOTOR	MODELOS	DESDE / A	
	ENGINE	MODELS	FROM / TO	
CA-1242-2ML	4L DOHC 16 V 98" HR16DE	MARCH, VERSA.	2012/2014	
1.6L	MOTOR	MODELOS	DESDE / A	
	ENGINE	MODELS	FROM / TO	
CA-1550-ML	4L DOHC 16V K4M-690	PLATINA, CLIQ, KANGOO CABEZA DE MLS).	2002/2009	
1.6L	MOTOR	MODELOS	DESDE / A	
	ENGINE	MODELS	FROM / TO	
CA-1550-G	4L DOHC 16V K4M-690	PLATINA, CLIQ, KANGOO, (CABEZA DE GRAFITO).	2002/2009	
1.8L	MOTOR	MODELOS	DESDE / A	
	ENGINE	MODELS	FROM / TO	
CA-1214-G	4L OHV 8V MOTOR CA18ET	200SX, STANZA.	1982/1988	
1.8L	MOTOR	MODELOS	DESDE / A	
	ENGINE	MODELS	FROM / TO	
CA-1234-ML	4L DOHC 16V QG18DE	SENTRA (CABEZA DE MLS).	2000/2003	
1.8L	MOTOR	MODELOS	DESDE / A	
	ENGINE	MODELS	FROM / TO	
CA-1234-G	4L DOHC 16V QG18DE	SENTRA, (CABEZA DE GRAFITO).	2000/2003	
1.8L	MOTOR	MODELOS	DESDE / A	
	ENGINE	MODELS	FROM / TO	
CA-1238-G	4L DOHC 16V MR18DE	TIIDA, SENTRA, VERSA.	2007/2011	
1.8L	MOTOR	MODELOS	DESDE / A	
	ENGINE	MODELS	FROM / TO	
CA-1238-ML	4L DOHC 16V MR18DE	TIIDA, SENTRA, VERSA.	2007/2011	



2.0L	MOTOR	MODELOS	DESDE / A	
	ENGINE	MODELS	FROM / TO	
CA-1214-G	4L OHV 8V MOTOR CA20E TURBOCARGADO	200SX, STANZA.	1982/1988	
2.0L	MOTOR	MODELOS	DESDE / A	
	ENGINE	MODELS	FROM / TO	
CA-1218-G	4L SOHC 8 VALV MOTOR L20B	200SX, PICK UP 720, 710, 620, 510.	1977/1980	
2.0L	MOTOR	MODELOS	DESDE / A	
	ENGINE	MODELS	FROM / TO	
CA-1222-G	4L SOHC 8V Z20E	200SX, PICK UP, 510.	1980/1981	
2.0L	MOTOR	MODELOS	DESDE / A	
	ENGINE	MODELS	FROM / TO	
CA-1228-G	4L DOHC 16V 122" SR20DE	200SX, LUCINO, SENTRA, TSURU 2000 GSR.	1992/2000	
2.0L	MOTOR	MODELOS	DESDE / A	
	ENGINE	MODELS	FROM / TO	
CA-1238-ML	4L DOHC 16V MR20DE	SENTRA.	2007/2011	
2.4L	MOTOR	MODELOS	DESDE / A	
	ENGINE	MODELS	FROM / TO	
CA-1224-G	4L SOHC 8V Z24I Z24S	CAMIONETAS VAN, PICK-UP 720, D21.	1983/1989	
2.4L	MOTOR	MODELOS	DESDE / A	
	ENGINE	MODELS	FROM / TO	
CA-1225-G	4L SOHC 12V KA24E KA24S	ICHI VAN, PICK-UP D21, ESTA-QUITAS.	1989/1993	
2.4L	MOTOR	MODELOS	DESDE / A	
	ENGINE	MODELS	FROM / TO	
CA-1232-G	4L DOHC 16V MOTOR KA24DE	FRONTIER, PICK UP, URVAN.	2000/2006	



<b>2.4L</b>	MOTOR	MODELOS	DESDE / A	
	ENGINE	MODELS	FROM / TO	
CA-1233-G	4L DOHC 16V MOTOR KA24DE	SOLO AUTOS ALTIMA.	1993/1999	
<b>2.5L</b>	MOTOR	MODELOS	DESDE / A	
	ENGINE	MODELS	FROM / TO	
CA-1235-G	4L DOHC 16 V QR25DE	X-TRAIL, ALTIMA, SENTRA (CABEZA DE GRAFITO).	2002/2006	
<b>2.5L</b>	MOTOR	MODELOS	DESDE / A	
	ENGINE	MODELS	FROM / TO	
CA-1235-ML	4L DOHC 16V "QR25DE"	X-TRAIL, ALTIMA, SENTRA (CABEZA DE MLS).	2002/2006	
<b>2.5L</b>	MOTOR	MODELOS	DESDE / A	
	ENGINE	MODELS	FROM / TO	
CA-1245-G	4L DOHC 16V QR25DE	ALTIMA, SENTRA, URVAN, FRONTIER, ROGUE (CABEZA DE GRAFITO).	2007/2009	
<b>2.5L</b>	MOTOR	MODELOS	DESDE / A	
	ENGINE	MODELS	FROM / TO	
CA-1245-ML	4L DOHC 16V "QR25DE"	ALTIMA, SENTRA, URVAN, FRONTIER, ROGUE (CABEZA DE MLS).	2007/2009	
<b>2.5L</b>	MOTOR	MODELOS	DESDE / A	
	ENGINE	MODELS	FROM / TO	
CA-1255-ML	4L DOHC 16V QR25DE	URVAN, FRONTIER, EQUATOR (CABEZA DE MLS).	2005/2012	
<b>2.5L</b>	MOTOR	MODELOS	DESDE / A	
	ENGINE	MODELS	FROM / TO	
CA-1255-G	4L DOHC 16V QR25DE	URVAN, FRONTIER, EQUATOR (CABEZA DE GRAFITO).	2005/2012	
<b>2.8L</b>	MOTOR	MODELOS	DESDE / A	
	ENGINE	MODELS	FROM / TO	
CA-1221-B	L6 SOHC 16V L28 L28ET	280ZX,	1981/1983	





3.0L	MOTOR	MODELOS	DESDE / A	
	ENGINE	MODELS	FROM / TO	
CA-1229-G	V6 SOHC 12V VG30 VG30E	FRONTIER, QUEST, X TERRA, MERCURY VILLAGER.	1986/1999	
3.0L	MOTOR	MODELOS	DESDE / A	
	ENGINE	MODELS	FROM / TO	
CA-1237-1ML	V6 DOHC 24V VQ30DE	MAXIMA, INFINITI I30.	2000/2001	
3.0L	MOTOR	MODELOS	DESDE / A	
	ENGINE	MODELS	FROM / TO	
CA-1243-ML	4L DOHC 16V, TDI ZD30DDTI	URVAN TURBODIESEL.	2001/2009	
3.0L	MOTOR	MODELOS	DESDE / A	
	ENGINE	MODELS	FROM / TO	
CA-1244-ML	V6 DOHC 24V VQ30DE VIN C	MAXIMA, INFINITI I30.	1995/1999	
3.3L	MOTOR	MODELOS	DESDE / A	
	ENGINE	MODELS	FROM / TO	
CA-1229-1G	V6 SOHC 12V VG33DE	PATHFINDER, FRONTIER, X-TERRA.	1996/2004	
3.5L	MOTOR	MODELOS	DESDE / A	
	ENGINE	MODELS	FROM / TO	
CA-1236-ML	V6 DOHC 24V VQ35DE	MAXIMA, ALTIMA, MURANO, QUEST, 350Z, INFINITI G35, I35. (IZQUIERDA)	2002/2008	
3.5L	MOTOR	MODELOS	DESDE / A	
	ENGINE	MODELS	FROM / TO	
CA-1236-1ML	V6 DOHC 24V VQ35DE	MAXIMA, ALTIMA, MURANO, QUEST, 350Z, INFINITI G35, I35. (DERECHA)	2002/2008	
3.5L	MOTOR	MODELOS	DESDE / A	
	ENGINE	MODELS	FROM / TO	
CA-1239-ML	V6 DOHC 24V VQ35DE	PATHFINDER, INFINITI, QX4, FX35. (IZQUIERDA)	2001/2004	



3.5L	MOTOR	MODELOS	DESDE / A
	ENGINE	MODELS	FROM / TO
CA-1239-1ML	V6 DOHC 24V VQ35DE	PATHFINDER, INFINITI, QX4, FX35. (DERECHA)	2001/2004



5.6L	MOTOR	MODELOS	DESDE / A
	ENGINE	MODELS	FROM / TO
CA-1256-G	V8 DOHC 32V VK56DE	ARMADA, TITAN, PATHFINDER (CABEZA DE GRAFITO). (DERECHA)	2004/2010



5.6L	MOTOR	MODELOS	DESDE / A
	ENGINE	MODELS	FROM / TO
CA-1256-1G	V8 DOHC 32V VK56DE	TITAN, ARMADA, PATHFINDER (CABEZA DE GRAFITO). (IZQUIERDA)	2004/2010



RENAULT ■

1.6L	MOTOR	MODELOS	DESDE / A
	ENGINE	MODELS	FROM / TO
CA-1530-G	4L OHV	R12, R18, TS.	1975/1984

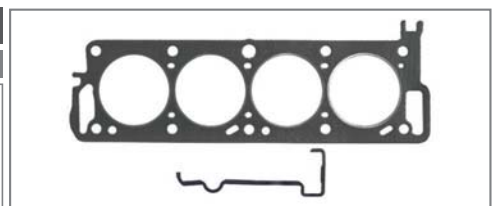



1.5L	MOTOR	MODELOS	DESDE / A	
	ENGINE	MODELS	FROM / TO	
CA-1304-G	4L SOHC 12V 3EE VIN E.	TERCEL.	1987/1994	
1.5L	MOTOR	MODELOS	DESDE / A	
	ENGINE	MODELS	FROM / TO	
CA-1305-ML	4L DOHC 16V.	TERCEL, PASEO.	1992/1995	
1.5L	MOTOR	MODELOS	DESDE / A	
	ENGINE	MODELS	FROM / TO	
CA-1305-1G	4L DOHC 16V.	TERCEL, PASEO.	1995/1999	
1.6L	MOTOR	MODELOS	DESDE / A	
	ENGINE	MODELS	FROM / TO	
CA-1301-B	4L OHV 8V.	COROLLA, CARINA.	1977/1979	
1.6L	MOTOR	MODELOS	DESDE / A	
	ENGINE	MODELS	FROM / TO	
CA-1307-G	4L DOHC 16V MOTOR 4AFE.	COROLLA , PRIZM.	1993/1997	
1.8L	MOTOR	MODELOS	DESDE / A	
	ENGINE	MODELS	FROM / TO	
CA-1307-ML	4L DOHC 16V 7AFE.	COROLLA , CELICA, GEO PRIZM.	1993/1997	
1.9L	MOTOR	MODELOS	DESDE / A	
	ENGINE	MODELS	FROM / TO	
CA-1300-B	4L OHV 8V	CELICA,CORONA,PICK-UP.	1968/1974	
1.8L	MOTOR	MODELOS	DESDE / A	
	ENGINE	MODELS	FROM / TO	
CA-1302-ML	4L DOHC 16V MOTOR 1ZZFE.	CELICA , COROLLA, MR2, MATRIX, PONTIAC VIBE, PRIZM.	1998/2009	



<b>2.0L</b>	MOTOR	MODELOS	DESDE / A	
	ENGINE	MODELS	FROM / TO	
CA-1321-G	4L SOHC 8V 2SELC.	CELICA, CAMRY.	1983/1986	
<b>2.0L</b>	MOTOR	MODELOS	DESDE / A	
	ENGINE	MODELS	FROM / TO	
CA-1323-G	4L SOHC 8V MOTOR 3YEC,	VAN CARGA.	1984/1985	
<b>2.0L</b>	MOTOR	MODELOS	DESDE / A	
	ENGINE	MODELS	FROM / TO	
CA-1324-G	4L DOHC 16V 5SFE, 3SFE.	CAMRY, CELICA, MR2.	1987/1995	
<b>2.0L</b>	MOTOR	MODELOS	DESDE / A	
	ENGINE	MODELS	FROM / TO	
CA-1322-G	4L DOHC 16V 5SFE, 3SFE.	CAMRY, CELICA, MR2.	1987/1995	
<b>2.0L</b>	MOTOR	MODELOS	DESDE / A	
	ENGINE	MODELS	FROM / TO	
CA-1325-ML	4L DOHC 16V MOTOR1AZFE	RAV4.	2001/2003	
<b>2.2L</b>	MOTOR	MODELOS	DESDE / A	
	ENGINE	MODELS	FROM / TO	
CA-1310-G	4L SOHC 8V 20R	CELICA, CORONA PICK-UP.	1975/1980	
<b>2.2L</b>	MOTOR	MODELOS	DESDE / A	
	ENGINE	MODELS	FROM / TO	
CA-1322-ML	4L DOHC 16V MOTOR 3SGTE TURBO.	MR2 TURBO.	1991	
<b>2.2L</b>	MOTOR	MODELOS	DESDE / A	
	ENGINE	MODELS	FROM / TO	
CA-1322-G	4L DOHC 16V 5SFE, 3SFE.	CAMRY, CELICA, MR2.	1987/1995	













2.2L	MOTOR	MODELOS	DESDE / A	
	ENGINE	MODELS	FROM / TO	
CA-1324-G	4L DOHC 16V 5SFE, 3SFE.	CAMRY, CELICA, MR2.	1987/1995	
2.4L	MOTOR	MODELOS	DESDE / A	
	ENGINE	MODELS	FROM / TO	
CA-1327-G	4L DOHC 16V 2TZFE, 2TZFZE.	PREVIA.	1991/1997	
2.4L	MOTOR	MODELOS	DESDE / A	
	ENGINE	MODELS	FROM / TO	
CA-1328-ML	4L DOHC 16V.	RAV4, CAMRY, HIGHLANDER.	2002/2007	
2.4L	MOTOR	MODELOS	DESDE / A	
	ENGINE	MODELS	FROM / TO	
CA-1330-G	4L DOHC 2RZFE	TACOMA.	1994/2004	
2.7L	MOTOR	MODELOS	DESDE / A	
	ENGINE	MODELS	FROM / TO	
CA-1352-G	4L DOHC 16V 3RZFE.	TACOMA, T-100, 4RUNNER.	1994/2004	
2.7L	MOTOR	MODELOS	DESDE / A	
	ENGINE	MODELS	FROM / TO	
CA-1354-ML	4L DOHC 16V 1ARFE, 2TRFE.	HIACE, HILUX, VENZA,	2005/2010	
3.0L	MOTOR	MODELOS	DESDE / A	
	ENGINE	MODELS	FROM / TO	
CA-1350-G	V6 SOHC 12V 3VZE.	4RUNNER, PICK-UP, T100.	1988/1995	
3.0L	MOTOR	MODELOS	DESDE / A	
	ENGINE	MODELS	FROM / TO	
CA-1351-G	V6 SOHC 12V 3VZE.	4RUNNER, PICK-UP, T100.	1988/1995	



<b>3.0L</b>	<b>MOTOR</b>	<b>MODELOS</b>	<b>DESDE / A</b>	
	<b>ENGINE</b>	<b>MODELS</b>	<b>FROM / TO</b>	
<b>CA-1353-G</b>	6L DOHC 24V 2JZGE VIN "J"	SUPRA, LEXUS SC300, IS300, GS300.	1993/1998	
<b>3.0L</b>	<b>MOTOR</b>	<b>MODELOS</b>	<b>DESDE / A</b>	
	<b>ENGINE</b>	<b>MODELS</b>	<b>FROM / TO</b>	
<b>CA-1353-ML</b>	DOHC 24v 2JZGE.	SUPRA, LEXUS, GS300, IS300, SC300	1992/2005	
<b>3.0L</b>	<b>MOTOR</b>	<b>MODELOS</b>	<b>DESDE / A</b>	
	<b>ENGINE</b>	<b>MODELS</b>	<b>FROM / TO</b>	
<b>CA-1355-G</b>	V6 DOHC 24V 3VZFE.	CAMRY, LEXUS ES300. (IZQUIERDA)	1992/1993	
<b>3.0L</b>	<b>MOTOR</b>	<b>MODELOS</b>	<b>DESDE / A</b>	
	<b>ENGINE</b>	<b>MODELS</b>	<b>FROM / TO</b>	
<b>CA-1355-1G</b>	V6 DOHC 24V 3VZFE.	CAMRY, LEXUS ES300. (DERECHA)	1992/1993	
<b>3.0L</b>	<b>MOTOR</b>	<b>MODELOS</b>	<b>DESDE / A</b>	
	<b>ENGINE</b>	<b>MODELS</b>	<b>FROM / TO</b>	
<b>CA-1356-G</b>	V6 DOHC 24V 1MZFE	CAMRY, AVALON, SIENNA, SOLARA.	1994/2000	
<b>3.0L</b>	<b>MOTOR</b>	<b>MODELOS</b>	<b>DESDE / A</b>	
	<b>ENGINE</b>	<b>MODELS</b>	<b>FROM / TO</b>	
<b>CA-1356-1G</b>	V6 DOHC 24V 1MZFE	CAMRY, AVALON, SIENNA, SOLARA.	1994/2000	
<b>3.0L</b>	<b>MOTOR</b>	<b>MODELOS</b>	<b>DESDE / A</b>	
	<b>ENGINE</b>	<b>MODELS</b>	<b>FROM / TO</b>	
<b>CA-1356-ML</b>	V6 DOHC 24V 1MZFE	CAMRY, AVALON, SIENNA, SOLARA. (DERECHA)	1994/2000	
<b>3.0L</b>	<b>MOTOR</b>	<b>MODELOS</b>	<b>DESDE / A</b>	
	<b>ENGINE</b>	<b>MODELS</b>	<b>FROM / TO</b>	
<b>CA-1356-1ML</b>	V6 DOHC 24V 1MZFE	CAMRY, AVALON, SIENNA, SOLARA. (IZQUIERDA)	1994/2000	

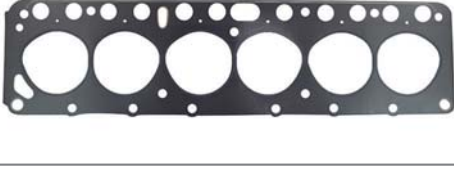

<b>3.4L</b>	MOTOR	MODELOS	DESDE / A	
	ENGINE	MODELS	FROM / TO	
CA-1357-G	V6 DOHC 24V 5VZFE.	TACOMA, 4RUNNER, T-100, TUNDRA. (IZQUIERDA)	1995/2004	
<b>3.4L</b>	MOTOR	MODELOS	DESDE / A	
	ENGINE	MODELS	FROM / TO	
CA-1358-G	V6 DOHC 24V 5VZFE.	TACOMA, 4RUNNER, T-100, TUNDRA. (DERECHA)	1995/2004	
<b>4.0L</b>	MOTOR	MODELOS	DESDE / A	
	ENGINE	MODELS	FROM / TO	
CA-1361-G	V8 DOHC 32V 1UZFE.	LEXUS LS400, SC400. (IZQUIERDA)	1990/1997	
<b>4.0L</b>	MOTOR	MODELOS	DESDE / A	
	ENGINE	MODELS	FROM / TO	
CA-1361-1G	V8 DOHC 32V 1UZFE.	LEXUS LS400, SC400. (DERECHA)	1990/1997	
<b>4.0L</b>	MOTOR	MODELOS	DESDE / A	
	ENGINE	MODELS	FROM / TO	
CA-1361-1ML	V8 DOHC 32V 1UZFE	LEXUS GS400, LS400, SC400. (IZQUIERDA)	1998/2000	
<b>4.0L</b>	MOTOR	MODELOS	DESDE / A	
	ENGINE	MODELS	FROM / TO	
CA-1361-ML	V8 DOHC 32V 1UZFE	LEXUS GS400, LS400, SC400. (DERECHA)	1998/2000	
<b>4.0L</b>	MOTOR	MODELOS	DESDE / A	
	ENGINE	MODELS	FROM / TO	
CA-1367-G	L6 OHV 12V.	LAND CRUISER.	1988/1992	
<b>4.2L</b>	MOTOR	MODELOS	DESDE / A	
	ENGINE	MODELS	FROM / TO	
CA-1367-G	6L OHV 12V.	LAND CRUISER.	1985/1987	



4.0L	MOTOR	MODELOS	DESDE / A
	ENGINE	MODELS	FROM / TO
CA-1365-ML	V6 4.0L DOHC 24V 1GRFE	4RUNNER (DERECHA)	2004/2006



3.0L	MOTOR	MODELOS	DESDE / A
	ENGINE	MODELS	FROM / TO
CA-1365-1ML	V6 4.0L DOHC 24V 1GRFE	4RUNNER (IZQUIERDA)	2004/2006



3.0L	MOTOR	MODELOS	DESDE / A
	ENGINE	MODELS	FROM / TO
CA-1369-ML	V8 5.7I DOHC 32v ENGINE 1URFSE	TUNDRA, LX570, LAND CRUISER, SEQUOIA. (DERECHA)	1992/1993



3.0L	MOTOR	MODELOS	DESDE / A
	ENGINE	MODELS	FROM / TO
CA-1369-1ML	V8 5.7I DOHC 32v ENGINE 1URFSE	TUNDRA, LX570, LAND CRUISER, SEQUOIA. (DERECHA)	2007/2013









1.2L	MOTOR	MODELOS	DESDE / A	
	ENGINE	MODELS	FROM / TO	
CA-1810-C	H4 8V BOXER	SEDAN.	1963/1965	
1.6L	MOTOR	MODELOS	DESDE / A	
	ENGINE	MODELS	FROM / TO	
CA-1835-G	4L SOHC 8V	LUPO, POLO, CROSSFOX, SPORT VAN, GOL.	2003/2014	
1.6L	MOTOR	MODELOS	DESDE / A	
	ENGINE	MODELS	FROM / TO	
CA-1835-ML	4L SOHC 8V BRASIL	LUPO, POLO, CROSSFOX, (CABEZA MLS).	2005/2012	
1.8L	MOTOR	MODELOS	DESDE / A	
	ENGINE	MODELS	FROM / TO	
CA-1840-G	4L SOHC 8V CARB & FI	JETTA A2, GOLF, CORSAR, CABRIOLET, RABBIT.	1983/1998	
1.8L	MOTOR	MODELOS	DESDE / A	
	ENGINE	MODELS	FROM / TO	
CA-1852-ML	4L DOHC 20V TURBO ADR ANB AFY	PASSAT, BEETLE, SHARAN, JETTA GLI, AUDI A4, A3.	2001/2012	
1.8L	MOTOR	MODELOS	DESDE / A	
	ENGINE	MODELS	FROM / TO	
CA-1852-G	4L DOHC 20V ADR ANB AFY	PASSAT, AUDI A4, GOLF, BEETLE.	1996/2005	
1.9L	MOTOR	MODELOS	DESDE / A	
	ENGINE	MODELS	FROM / TO	
CA-1860-ML	4L SOHC 8V TDI	EUROVAN, TRANSPORTER.	2006/2009	
2.0L	MOTOR	MODELOS	DESDE / A	
	ENGINE	MODELS	FROM / TO	
CA-1845-ML	4L SOHC	JETTA A3, GOLF, CABRIO (CABEZA EN MLS).	1993/1999	



2.0L	MOTOR	MODELOS	DESDE / A	
	ENGINE	MODELS	FROM / TO	
CA-1845-G	4L SOHC 8V ABA	JETTA A3, GOLF, CABRIO.	1993/1999	
2.0L	MOTOR	MODELOS	DESDE / A	
	ENGINE	MODELS	FROM / TO	
CA-1850-G	4L SOHC 8V AEG AVH AZG	JETTA A4, GOLF, BEETLE, IBIZA (CABEZA EN GRAFITO).	2000/2007	
2.0L	MOTOR	MODELOS	DESDE / A	
	ENGINE	MODELS	FROM / TO	
CA-1850-ML1	4L SOHC 8V AEG AVH AZG	JETTA A4, GOLF, BEETLE, IBIZA (CABEZA EN MLS).	2000/2007	
2.0L	MOTOR	MODELOS	DESDE / A	
	ENGINE	MODELS	FROM / TO	
CA-1850-ML	4L SOHC 8V AEG AVH AZG	JETTA A4, GOLF, BEETLE, IBIZA (CABEZA EN MLS).	2000/2007	
2.0L	MOTOR	MODELOS	DESDE / A	
	ENGINE	MODELS	FROM / TO	
CA-1855-ML	4L DOHC 16V TURBO	PASSAT, JETTA GLI.	2010/2013	
2.0L	MOTOR	MODELOS	DESDE / A	
	ENGINE	MODELS	FROM / TO	
CA-1855-1ML	4L DOHC 16V TURBO	AUDI, A3, TT.	2008/2011	
2.5L	MOTOR	MODELOS	DESDE / A	
	ENGINE	MODELS	FROM / TO	
CA-1851-B	5L SOHC 10V	CARGOVAN, EUROVAN.	2001/2004	
2.5L	MOTOR	MODELOS	DESDE / A	
	ENGINE	MODELS	FROM / TO	
CA-1856-ML	5L DOHC 20V CBTA CBUA BGP	BORA, BEETLE.	2005/2010	

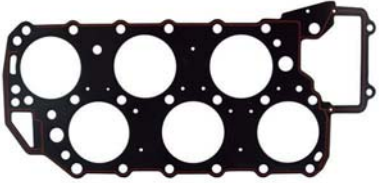

2.5L	MOTOR	MODELOS	DESDE / A	
	ENGINE	MODELS	FROM / TO	
CA-1870-ML	5L SOHC 10V TDI AEN AAF ACU	EUROVAN, TRANSPORTER.	2001/2004	
2.8L	MOTOR	MODELOS	DESDE / A	
	ENGINE	MODELS	FROM / TO	
CA-1853-ML	V6 DOHC 30V	PASSAT, AUDI A4, A6.	1997/2001	
2.8L	MOTOR	MODELOS	DESDE / A	
	ENGINE	MODELS	FROM / TO	
CA-1854-G	V6 SOHC 12V AFP	JETTA VR6, TRANSPORTER, SHARAN, GOLF GTI,	1992/2003	



NOTAS / NOTES:

A series of horizontal lines providing a space for handwritten notes or additional information.



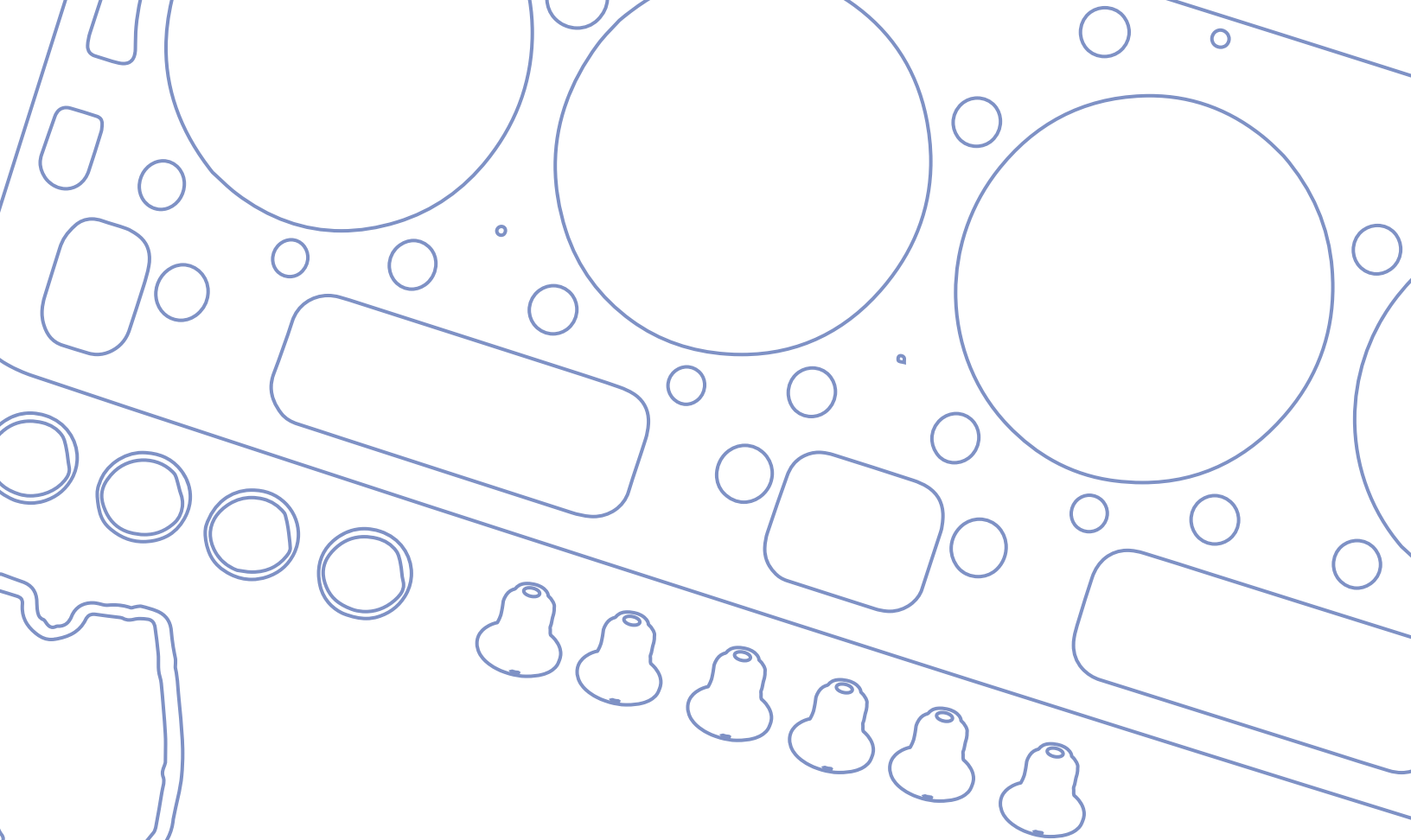

**JUNTAS EN SOBRE MEDIDA**  
**/ OVER SIZE GASKETS**

**SECCIÓN**  
**/SECTION**

CATÁLOGO DE APLICACIONES / APPLICATION CATALOG

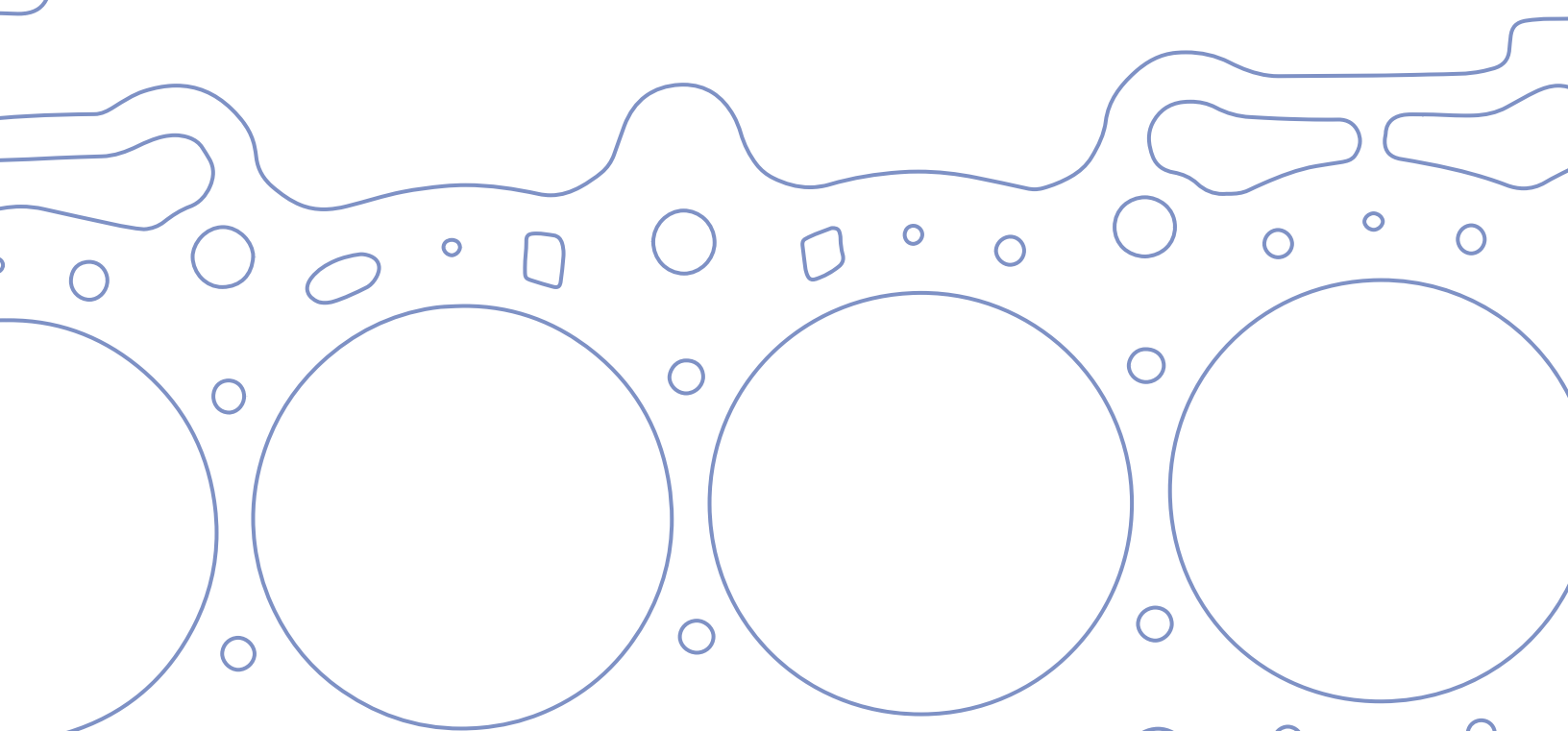





1.5 L	MOTOR	MODELOS	DESDE / A	
	ENGINE	MODELS	FROM / TO	
CA-1452-GX	4L SOHC 16V "D15B1", "D15B6", "D15B12"	HONDA CIVIC MEXICO, (sobremedida+.010").	1997/2001	
1.6 L	MOTOR	MODELOS	DESDE / A	
	ENGINE	MODELS	FROM / TO	
CA-100-1GX	4L SOHC 8V TBI & MPFI	CHEVROLET, CHEVY, CHEVY C2, JOY, MONZA, PICK-UP, (sobremedida+.020")	1996/2010	
1.6 L	MOTOR	MODELOS	DESDE / A	
	ENGINE	MODELS	FROM / TO	
CA-1210-GX	4L OHV 8V MOTOR "J15"; "J16"	DATSUN NISSAN, AUTOS Y CAMIONETAS, (sobremedida+.015").	1970/1983	
1.6 L	MOTOR	MODELOS	DESDE / A	
	ENGINE	MODELS	FROM / TO	
CA-317-GX	4L SOHC 8 V "ZETEC ROCAM"	FORD, FIESTA, IKON, KA, PICK-UP, COURIER, (sobremedida+.010").	2001/2010	
1.6 L	MOTOR	MODELOS	DESDE / A	
	ENGINE	MODELS	FROM / TO	
CA-1455-GX	4L SOHC 16V "B16A2", "B16A3", VTEC	HONDA CIVIC, ACURA, (sobremedida+.010").	1994/2001	
1.6L	MOTOR	MODELOS	DESDE / A	
	ENGINE	MODELS	FROM / TO	
CA-1226-1GX	L4 1.6L 16V DOHC "GA16DE/DNE" MOTOR MEXICO.	TSURU GSI, GSII, SENTRA, (sobremedida+.020").	1995/2010	
1.8 L	MOTOR	MODELOS	DESDE / A	
	ENGINE	MODELS	FROM / TO	
CA-1238-GX	4L DOHC 16 V MR18DE, MR20DE.	NISSAN, TIIDA, SENTRA, (sobremedida+.020").	2007/2011	
2.0 L	MOTOR	MODELOS	DESDE / A	
	ENGINE	MODELS	FROM / TO	
CA-108-XG	4L OHV 8V MOTOR 122", 134".	CHEVROLET CAVALIER, PICK-UP, S10, BLAZER, (sobremedida+.020").	1987/1997	



2.0 L	MOTOR	MODELOS	DESDE / A	
	ENGINE	MODELS	FROM / TO	
CA-235-1GX	L4 SOHC, DOHC "G63B", "4G63"	"CHRSYLER, DODGE, MITSUBISHI, COLT, RAM 50, HYUNDAI STELLAR, MITSUBHISH GALANT, (sobremedida+.010")	1983/1998	
2.0 L	MOTOR	MODELOS	DESDE / A	
	ENGINE	MODELS	FROM / TO	
CA-1320-GX	4L SOHC 8V "20R", "22RE", "22RTEC"	TOYOTA, 4RUNNER, CELICA GT, GTS, ST, CORONA, PICKUP, VAN WAGON, (sobremedida+.010")	1980/1995	
2.2 L	MOTOR	MODELOS	DESDE / A	
	ENGINE	MODELS	FROM / TO	
CA-1224-GX	4L SOHC "Z22E" "Z22S"; "Z24I", "Z24S"	NISSAN AUTOS Y CAMIONETAS. (sobremedida+.020")	1981/1989	
2.3 L	MOTOR	MODELOS	DESDE / A	
	ENGINE	MODELS	FROM / TO	
CA-1463-GX	4L SOHC VIN "F22B6"	HONDA ACCORD, ACURA, ODISEY, (sobremedida+.010")	1994/2002	
2.4 L	MOTOR	MODELOS	DESDE / A	
	ENGINE	MODELS	FROM / TO	
CA-1225-GX	4L SOHC 12 V; KA24E, KA24S	NISSAN, ICHI VAN; PICK-UP, ESTAQUITAS, (sobremedida+.020")	1989/2003	
2.4 L	MOTOR	MODELOS	DESDE / A	
	ENGINE	MODELS	FROM / TO	
CA-226-GX	4L DOHC 16V MOTOR "GEMA" VIN "W"	CHRYSLER DODGE, COMPASS, PATRIOT, JOURNEY, AVENGER.	2007/2013	
2.5 L	MOTOR	MODELOS	DESDE / A	
	ENGINE	MODELS	FROM / TO	
CA-1235-GX	4L DOHC 16 V "QR25DE"	NISSAN, ALTIMA, MAXIMA, SENTRA, , X-TRAIL, (sobremedida+.020")	2000/2006	
2.5 L	MOTOR	MODELOS	DESDE / A	
	ENGINE	MODELS	FROM / TO	
CA-1241-GX	4L DOHC 16 V MOTOR YD-25DDTI	NISSAN, CABSTAR, (sobremedida+.020")	2008/2010	





2.5 L	MOTOR	MODELOS	DESDE / A	
	ENGINE	MODELS	FROM / TO	
CA-1245-GX	4L DOHC 16V CODIGO DE MOTOR QR25DE.	NISSAN, ALTIMA, SENTRA, URVAN, ROGUE.	2007/2009	
2.6 L	MOTOR	MODELOS	DESDE / A	
	ENGINE	MODELS	FROM / TO	
CA-250-XG	4L SOHC 8V, VIN 7, E, G, W, G54B	CHRYSLER, MITSUBISHI, MINIVANS, TRUCKS (sobremedida+.020")	1982/1989	
3.0 L	MOTOR	MODELOS	DESDE / A	
	ENGINE	MODELS	FROM / TO	
CA-253-XG	V6 SOHC 12V "6G72"	CHRYSLER, DODGE, MITSUBISHI, IMPERIAL, VOYAGER, CARAVAN, (sobremedida+.020")	1987/2000	
4.9 L	MOTOR	MODELOS	DESDE / A	
	ENGINE	MODELS	FROM / TO	
CA-325-XG	L6 OHV 12V 240", 300"	FORD E-150 ECONOLINE, BRONCO, COUNTRY SEDAN, (sobremedida+.010").	1965/1996	
5.4 L	MOTOR	MODELOS	DESDE / A	
	ENGINE	MODELS	FROM / TO	
CA-356-GX	V8 SOHC 16/24V "TRITON"	FORD, LINCOLN, GRAND MARQUIS, F-250, F-350, LOBO. (LADO IZQUIERDO).	1991/2007	
5.4 L	MOTOR	MODELOS	DESDE / A	
	ENGINE	MODELS	FROM / TO	
CA-357-GX	V8 SOHC 16/24V "TRITON"	FORD, LINCOLN, GRAND MARQUIS, F-250, F-350, LOBO; (LADO DERECHO)	1991/2007	
6.5 L	MOTOR	MODELOS	DESDE / A	
	ENGINE	MODELS	FROM / TO	
CA-180-GX	V8 V8 OHV 16V VIN "F""S" DIESEL	GM CHEVROLET, SUBURBAN, EXPRESS VAN, YUKON, SAVANA 2500, 3500, (sobremedida+.010").	1992/2005	



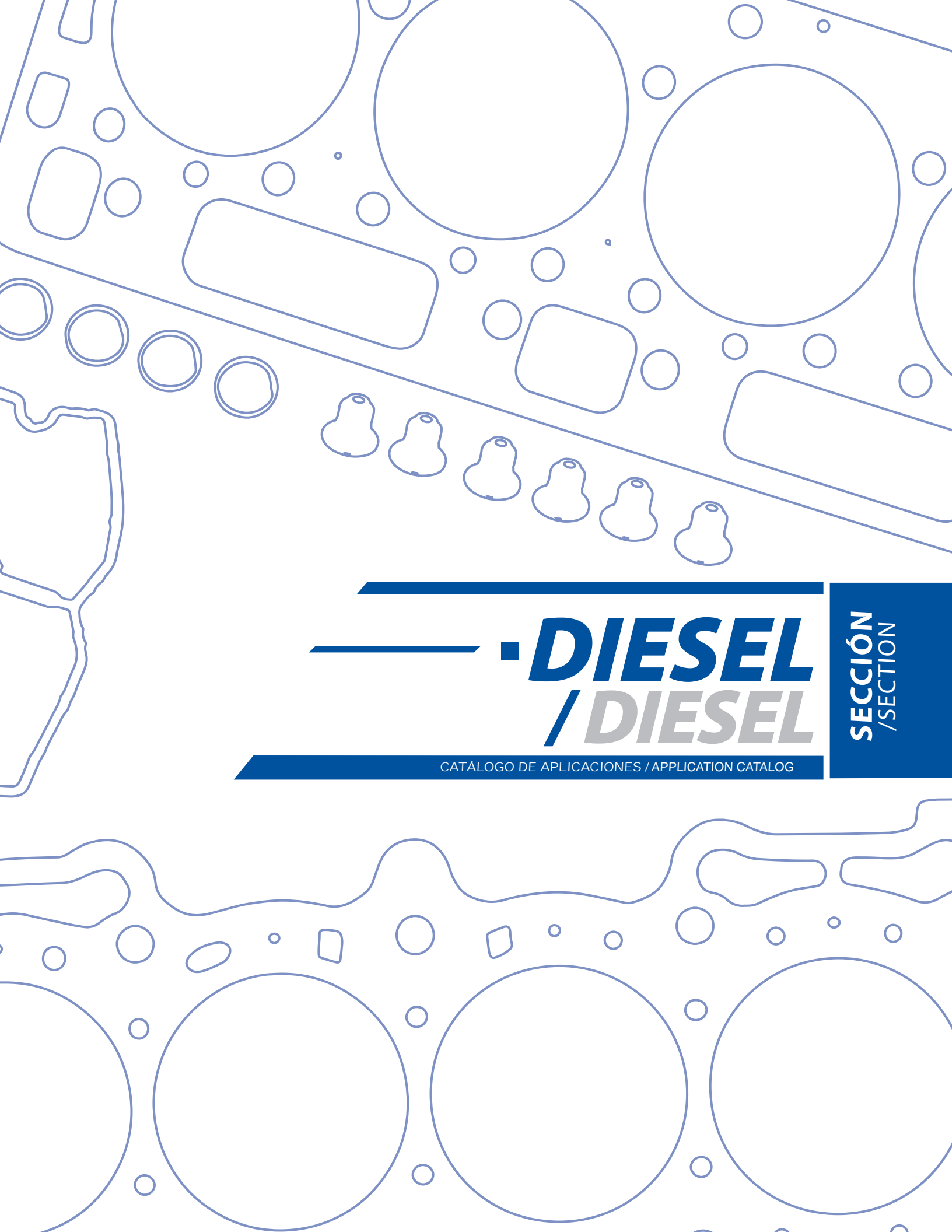

**DIESEL**  
**/ DIESEL**

**SECCIÓN**  
**/SECTION**

CATÁLOGO DE APLICACIONES / APPLICATION CATALOG







DODGE, HYUNDAI		FS-206-D
MOTOR	MODELOS	DESDE / A
ENGINE	MODELS	FROM / TO
4L 2.5L 8V SOHC TURBO DIESEL, MOTOR MITSUBISHI "4D56T"	DODGE H-100 (MEXICO)	2005/2009

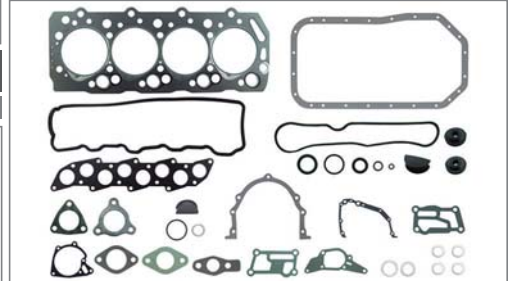

GM CHEVROLET		FS-179
MOTOR	MODELOS	DESDE / A
ENGINE	MODELS	FROM / TO
V8 6.2L 16V OHV VIN C,X,J (LD/HD)	SUBURBAN ,C1500,C2500,C3500 INCLU- YE VAN 1500,2500,3500	1982/1993

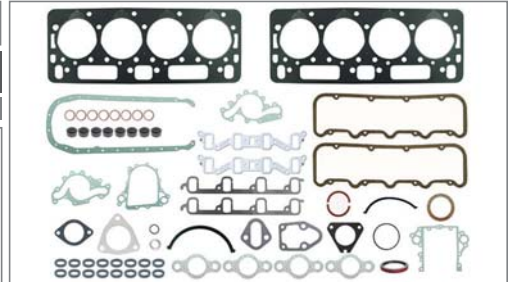

GM CHEVROLET		FS-180
MOTOR	MODELOS	DESDE / A
ENGINE	MODELS	FROM / TO
V8 6.5L/6.2L OHV 16V DIESEL VIN F, P, S, Y, Z.	BLAZER, C1500, C2500, C3500 SUBUR- BAN, EXPRESS 2500, 3500	1994/2005

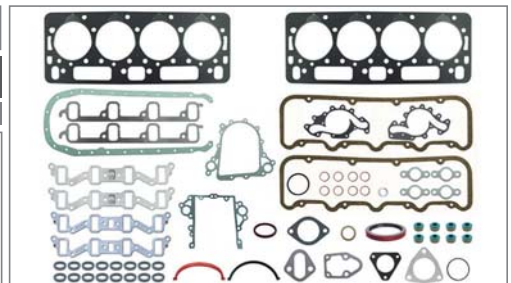

ISUZU ELF		FS-1780-ML
MOTOR	MODELOS	DESDE / A
ENGINE	MODELS	FROM / TO
4L 3.0L 16V DOHC SERIE 200/300	ISUZU ELF, (4JJ1-TC )138HP	2008/2013



NISSAN		FS-1241-ML
MOTOR	MODELOS	DESDE / A
ENGINE	MODELS	FROM / TO
4L 2.5L 16V DOHC DIESEL YD- 25DDTi	CABSTAR	2008/2014



TOYOTA		FS-1380-ML
MOTOR	MODELOS	DESDE / A
ENGINE	MODELS	FROM / TO
4L 4.0L 16V DIESEL SERIE 300	HINO(CHASIS 514,616,)MEXICO	2009/2014



**TOYOTA****FS-1382**

MOTOR	MODELOS	DESDE / A
ENGINE	MODELS	FROM / TO
4L 4.7L 16V DIESEL SERIE 500	(CHASIS 1018)(J05D-TG) HINO MEXICO	2009/2014

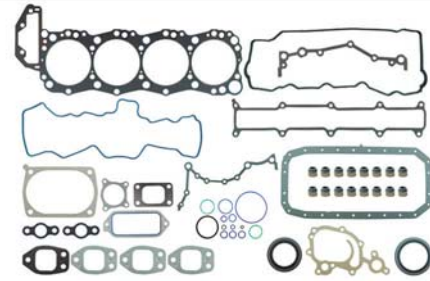
**FORD****HS-396-1G**

MOTOR	MODELOS	DESDE / A
ENGINE	MODELS	FROM / TO
V8 7.3L 16V OHV DIESEL	TURBO DIESEL SUPER DUTY E-550 ECONOLINE, EXCURSION F-450 SUPER DUTY	1995/2003

**DODGE****CA-249-ML**

MOTOR	MODELOS	DESDE / A
ENGINE	MODELS	FROM / TO
L6 5.9L OHV 24 V CUMMINS	CAMIONES DIESEL; RAM 2500, RAM 3500	2009/2009

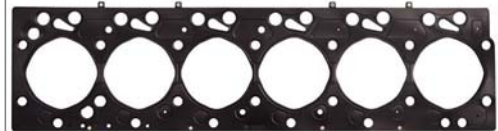
**DODGE****CA-249-B**

MOTOR	MODELOS	DESDE / A
ENGINE	MODELS	FROM / TO
L6 5.9L OHV 12 V CUMMINS	CAMIONES DIESEL; RAM 2500, RAM 3500	1984/1993

**FORD****CA-376-G**

MOTOR	MODELOS	DESDE / A
ENGINE	MODELS	FROM / TO
V8 7.3L 16V OHV DIESEL VIN F	INTERNATIONAL POWER STROKE VIN "F" E-250, E-350 ECONOLINE F-150 F-250 Y F59	1988/1994

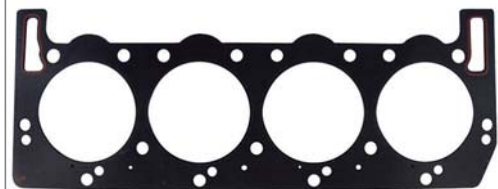
**FORD****CA-396-1G**

MOTOR	MODELOS	DESDE / A
ENGINE	MODELS	FROM / TO
V8 7.3L 16V OHV DIESEL VIN F	INTERNATIONAL POWER STROKE VIN "F" E-250, E-350 ECONOLINE F-150 F-250 Y F59	1994/2003



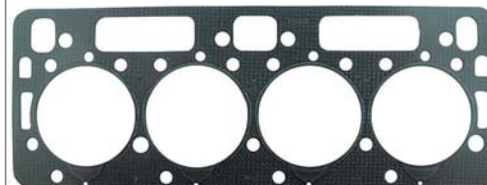

**GM CHEVROLET**
**CA-179-G**

MOTOR	MODELOS	DESDE / A
ENGINE	MODELS	FROM / TO
V8 6.2L 16V OHV DIESEL VIN C, J.	SUBURBAN C1500,C2500,C3500 HEAVY & LIGHT DUTY	1982/1993

**GM CHEVROLET**
**CA-179-GX**

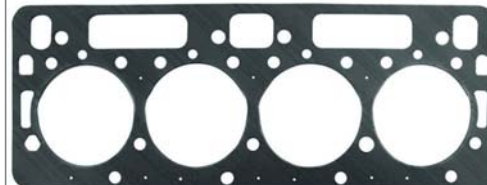
MOTOR	MODELOS	DESDE / A
ENGINE	MODELS	FROM / TO
V8 6.2L 16V OHV DIESEL VIN C, J.	SUBURBAN C1500,C2500,C3500 HEAVY & LIGHT DUTY	1982/1993

**GM CHEVROLET**
**CA-180-GD**

MOTOR	MODELOS	DESDE / A
ENGINE	MODELS	FROM / TO
V8 6.5L 16V OHV DIESEL VIN F, P, S, Y, Z,	SUBURBAN, C1500, C2500, C3500 SUBURBAN, EXPRESS 2500, 3500	1994/2005

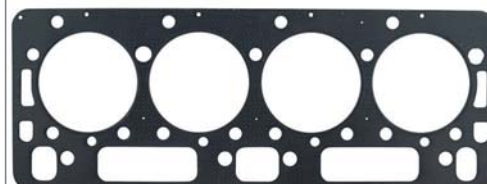
**GM CHEVROLET**
**CA-180-GX**

MOTOR	MODELOS	DESDE / A
ENGINE	MODELS	FROM / TO
V8 6.5L 16V OHV DIESEL VIN F, P, S, Y, Z.	SUBURBAN, EXPRESS VAN, YUKON, SAVANA 2500, 3500	1992/2005

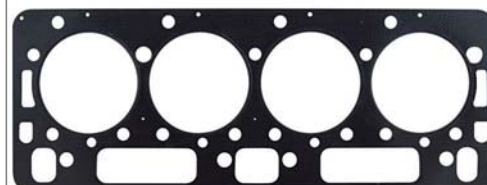
**NISSAN**
**CA-1241-GX**

MOTOR	MODELOS	DESDE / A
ENGINE	MODELS	FROM / TO
4L 2.5L 16V DOHC DIESEL YD-25DDTi	CABSTAR (SOBREMEDIDA 0.60")	2008/2014

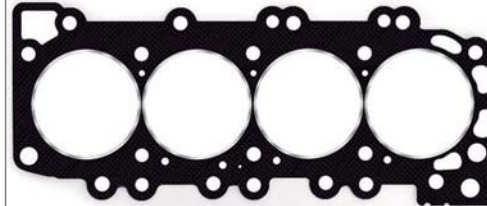
**NISSAN**
**CA-1243-ML**

MOTOR	MODELOS	DESDE / A
ENGINE	MODELS	FROM / TO
4L 3.0L 16V DOHC TURBODIESEL ENGINE ZD30DDTi	NISSAN URVAN (0.028") "OO"	2001/2009





VOLKSWAGEN		CA-1870-ML
MOTOR	MODELOS	DESDE / A
ENGINE	MODELS	FROM / TO
5L 2.5L 10V MOTOR AEN, AAF Y ACU.	EUROVAN TRANSPORTER TDI	2001/2004



VOLKSWAGEN		CA-1860-ML
MOTOR	MODELOS	DESDE / A
ENGINE	MODELS	FROM / TO
4L 1.9L 8V SOHC TDI	EUROVAN, TRANSPORTER TDI, 0.090" PULG. (2.29 mm)	2006/2009



FORD		LS-396
MOTOR	MODELOS	DESDE / A
ENGINE	MODELS	FROM / TO
V8 6.9L/7.3L 16V OHV DIESEL	FORD DIESEL.	1988/1995

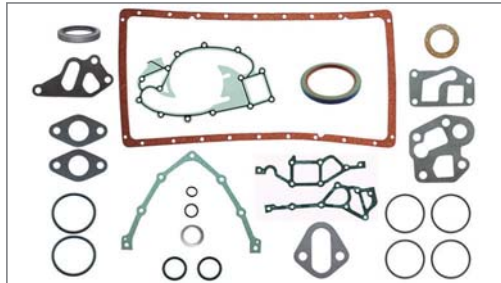

FORD		LS-396-1
MOTOR	MODELOS	DESDE / A
ENGINE	MODELS	FROM / TO
V8 7.3L 16V OHV DIESEL VIN F	INTERNATIONAL ENGINE LOWER SET	1994/1995

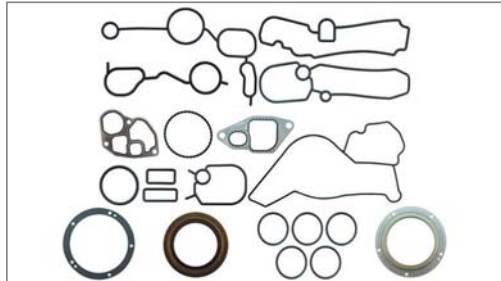

FORD		LS-396-2
MOTOR	MODELOS	DESDE / A
ENGINE	MODELS	FROM / TO
V8 7.3L 16V OHV DIESEL VIN F	INTERNATIONAL ENGINE LOWER SET	1999/2003

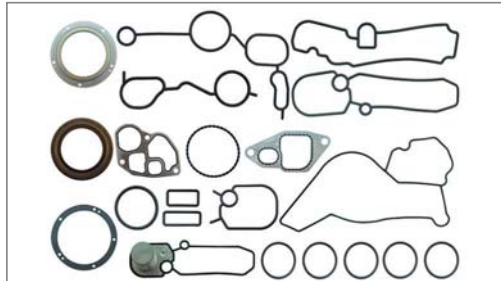

DODGE		VS-3249-R
MOTOR	MODELOS	DESDE / A
ENGINE	MODELS	FROM / TO
L6 5.9L OHV 24 V CUMMINS	CAMIONES DIESEL; RAM 2500, RAM 3500	2003/2011

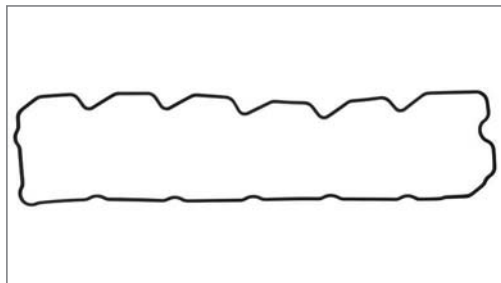





**DODGE**
**VS-3249-NR**

MOTOR	MODELOS	DESDE / A
ENGINE	MODELS	FROM / TO
L6 5.9L OHV 24 V CUMMINS	CAMIONES DIESEL; RAM 2500, RAM 3500	2006/2011

**FORD**
**VS-3396**

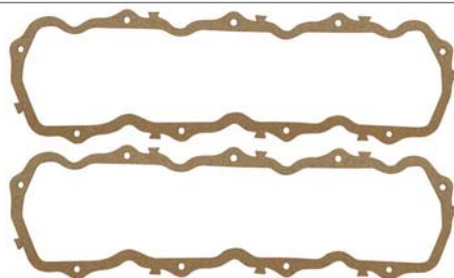
MOTOR	MODELOS	DESDE / A
ENGINE	MODELS	FROM / TO
V8 6.9L/7.3L 16V OHV DIESEL	FORD DIESEL	1983/1994

**FORD**
**VS-3396-R**

MOTOR	MODELOS	DESDE / A
ENGINE	MODELS	FROM / TO
V8 6.9L/7.3L 16V OHV DIESEL	FORD DIESEL	1983/1994

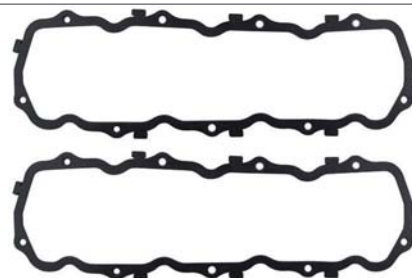
**FORD**
**VS-3396-1R**

MOTOR	MODELOS	DESDE / A
ENGINE	MODELS	FROM / TO
V8 7.3L 16V OHV DIESEL VIN F	INTERNATIONAL POWER STROKE VIN "F" E-250, E-350 ECONOLINE F-150 F-250.	1994/1997

**FORD**
**VS-3396-2R**

MOTOR	MODELOS	DESDE / A
ENGINE	MODELS	FROM / TO
V8 7.3L 16V OHV DIESEL VIN F	INTERNATIONAL POWER STROKE VIN "F" E-250, E-350 ECONOLINE F-150 F-250.	1998/2003

**GM CHEVROLET**
**VS-3180**

MOTOR	MODELOS	DESDE / A
ENGINE	MODELS	FROM / TO
V8 6.5L/6.2L OHV 16V DIESEL VIN F, P, S, Y, Z.	SUBURBAN, VAN, C1500, C2500, C3500, HUMMER	1982/2004

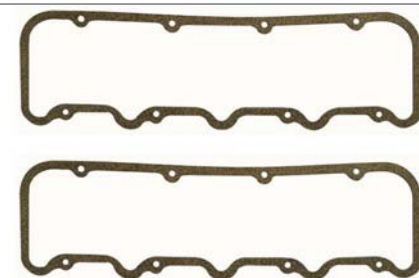

**FORD****MS-4396-E**

MOTOR	MODELOS	DESDE / A
ENGINE	MODELS	FROM / TO
V8 6.9L/7.3L 16V OHV DIESEL	FORD DIESEL	1983/1994

**FORD****MS-4396-1E**

MOTOR	MODELOS	DESDE / A
ENGINE	MODELS	FROM / TO
V8 7.3L 16V OHV DIESEL VIN F	FORD DIESEL	1994/1999

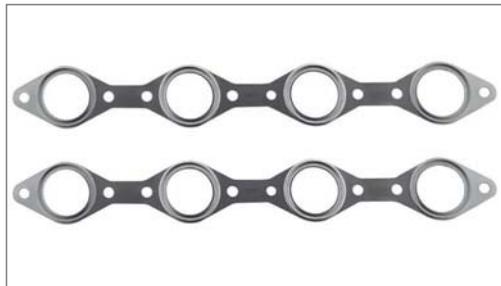
**FORD****MS-4396-2E**

MOTOR	MODELOS	DESDE / A
ENGINE	MODELS	FROM / TO
V8 7.3L 16V OHV DIESEL VIN F	FORD DIESEL	2001/2003

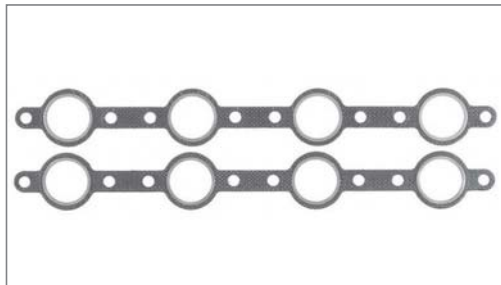
**GM CHEVROLET****MS-4180-1**

MOTOR	MODELOS	DESDE / A
ENGINE	MODELS	FROM / TO
V8 6.5L/6.2L OHV 16V DIESEL VIN J	SUBURBAN C1500, C2500, C3500 LIGHT DUTY	1982/2004

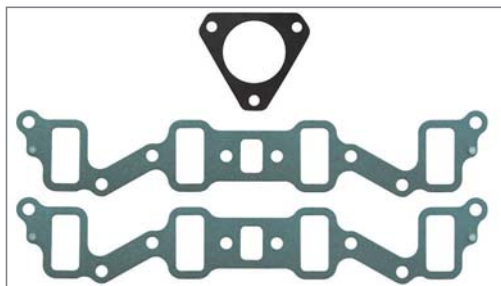
**GM CHEVROLET****MS-4180-AD**

MOTOR	MODELOS	DESDE / A
ENGINE	MODELS	FROM / TO
V8 6.5L/6.2L OHV 16V DIESEL VIN J	SUBURBAN C1500, C2500, C3500 LIGHT DUTY (VENTANA TAPADA)	1982/2004

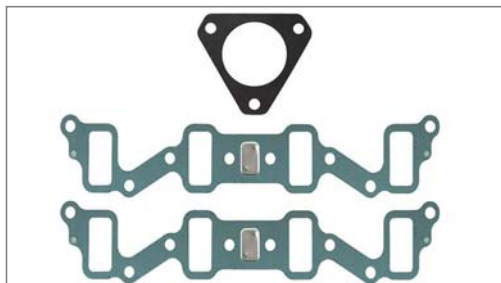
**GM CHEVROLET****MS-4180-E**

MOTOR	MODELOS	DESDE / A
ENGINE	MODELS	FROM / TO
V8 6.5L/6.2L OHV 16V DIESEL VIN J	SUBURBAN, VAN, C1500, C2500, C3500, HUMMER	1982/2004





**GM CHEVROLET**

**MS-4180-P**

MOTOR	MODELOS	DESDE / A
ENGINE	MODELS	FROM / TO
V8 6.5L/6.2L OHV 16V DIESEL VIN J	SUBURBAN, VAN,C1500,C2500,- C3500,HUMMER	1992/2002

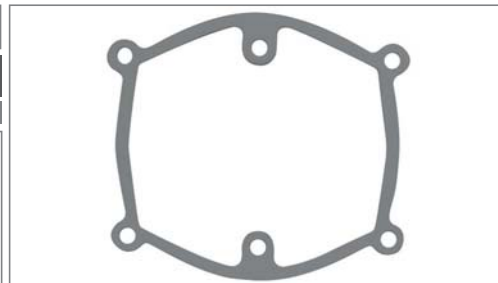

**FORD**

**OS-1396**

MOTOR	MODELOS	DESDE / A
ENGINE	MODELS	FROM / TO
V8 420-445 (6.9L-7.3L)	FORD DIESEL	1983/1994

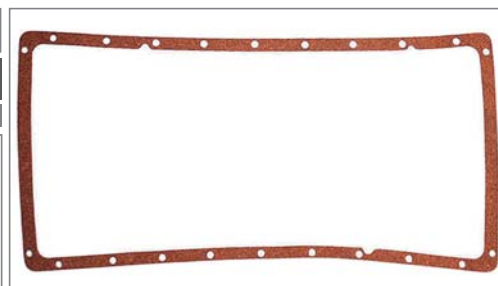

**GM CHEVROLET**

**OS-1180-A**

MOTOR	MODELOS	DESDE / A
ENGINE	MODELS	FROM / TO
V8 6.5L/6.2L OHV 16V DIESEL VIN J	CAMIONES DIESEL	1992/2004

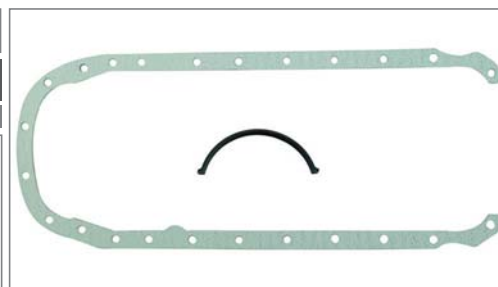

**FORD**

**TC-6396**

MOTOR	MODELOS	DESDE / A
ENGINE	MODELS	FROM / TO
V8 6.9L/7.3L 16V OHV DIESEL	FORD DIESEL	1983/1994

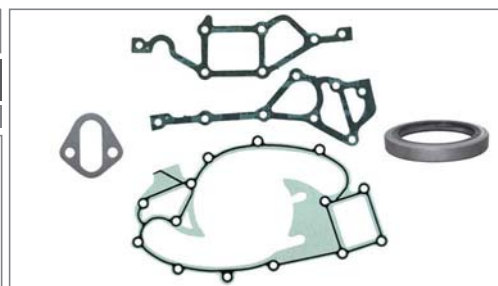

**FORD**

**TC-6396-1**

MOTOR	MODELOS	DESDE / A
ENGINE	MODELS	FROM / TO
V8 6.9L/7.3L 16V OHV DIESEL	FORD DIESEL	1994/1995

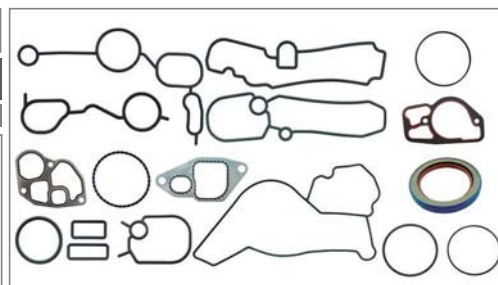

**FORD**

**TC-6396-2**

MOTOR	MODELOS	DESDE / A
ENGINE	MODELS	FROM / TO
V8 7.3L 16V OHV DIESEL VIN F	FORD DIESEL	1996/1999

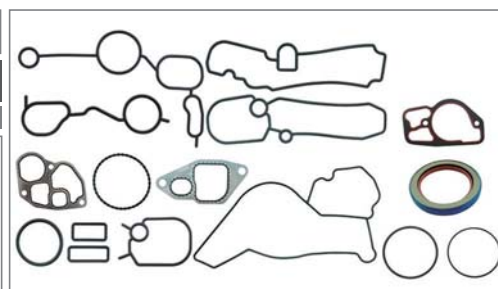



## FORD

SS-8396-V

MOTOR	MODELOS	DESDE / A
ENGINE	MODELS	FROM / TO
V8 7.3L 16V OHV DIESEL VIN F	FORD DIESEL	1988/1994



## FORD

SS-8396-1V

MOTOR	MODELOS	DESDE / A
ENGINE	MODELS	FROM / TO
V8 7.3L (445 CID) 16V DIESEL VIN F	FORD DIESEL	1994/2001





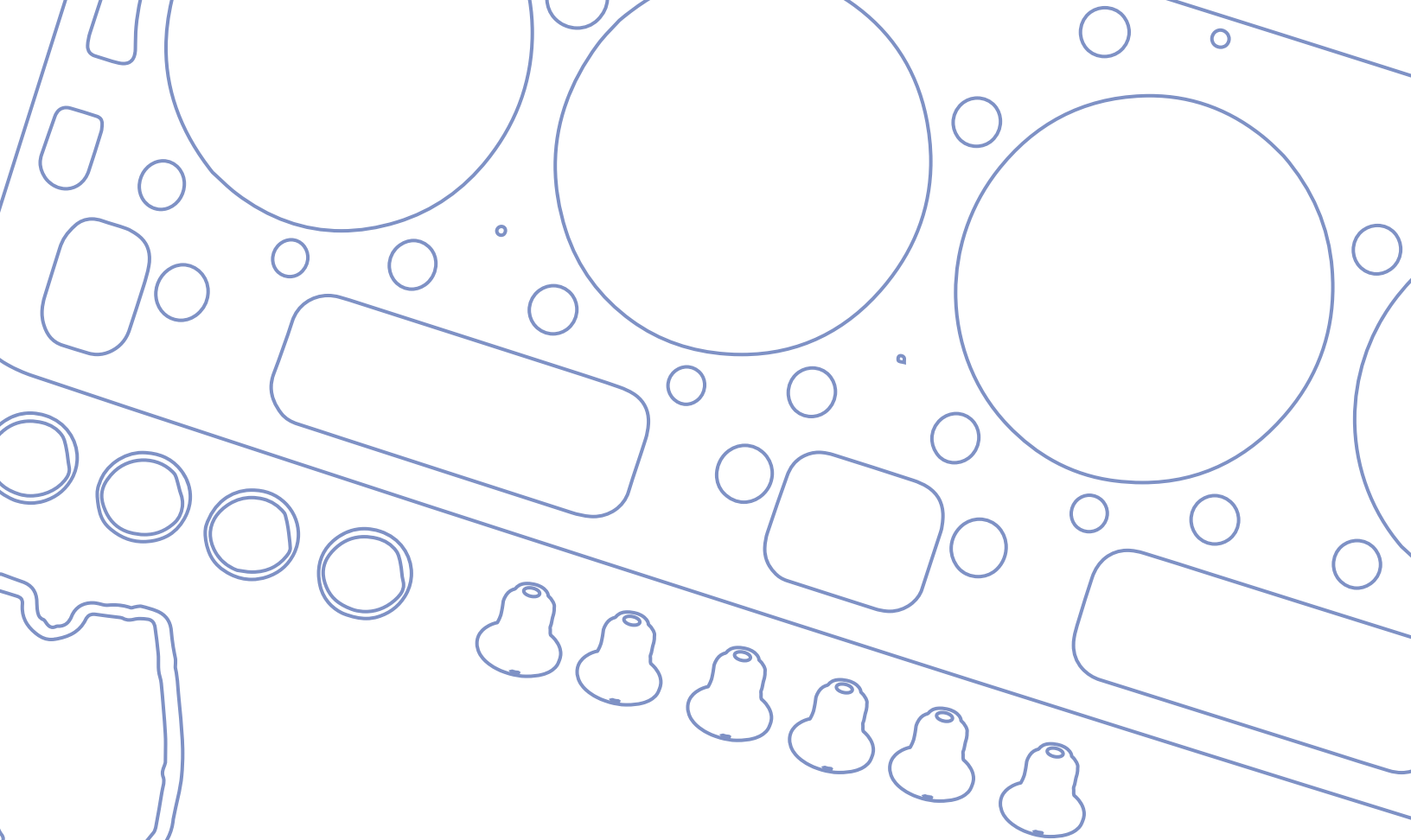

# **SELLOS DE VÁLVULA** **/ VALVE STEM SEALS**

**SECCIÓN**  
**/SECTION**

CATÁLOGO DE APLICACIONES / APPLICATION CATALOG

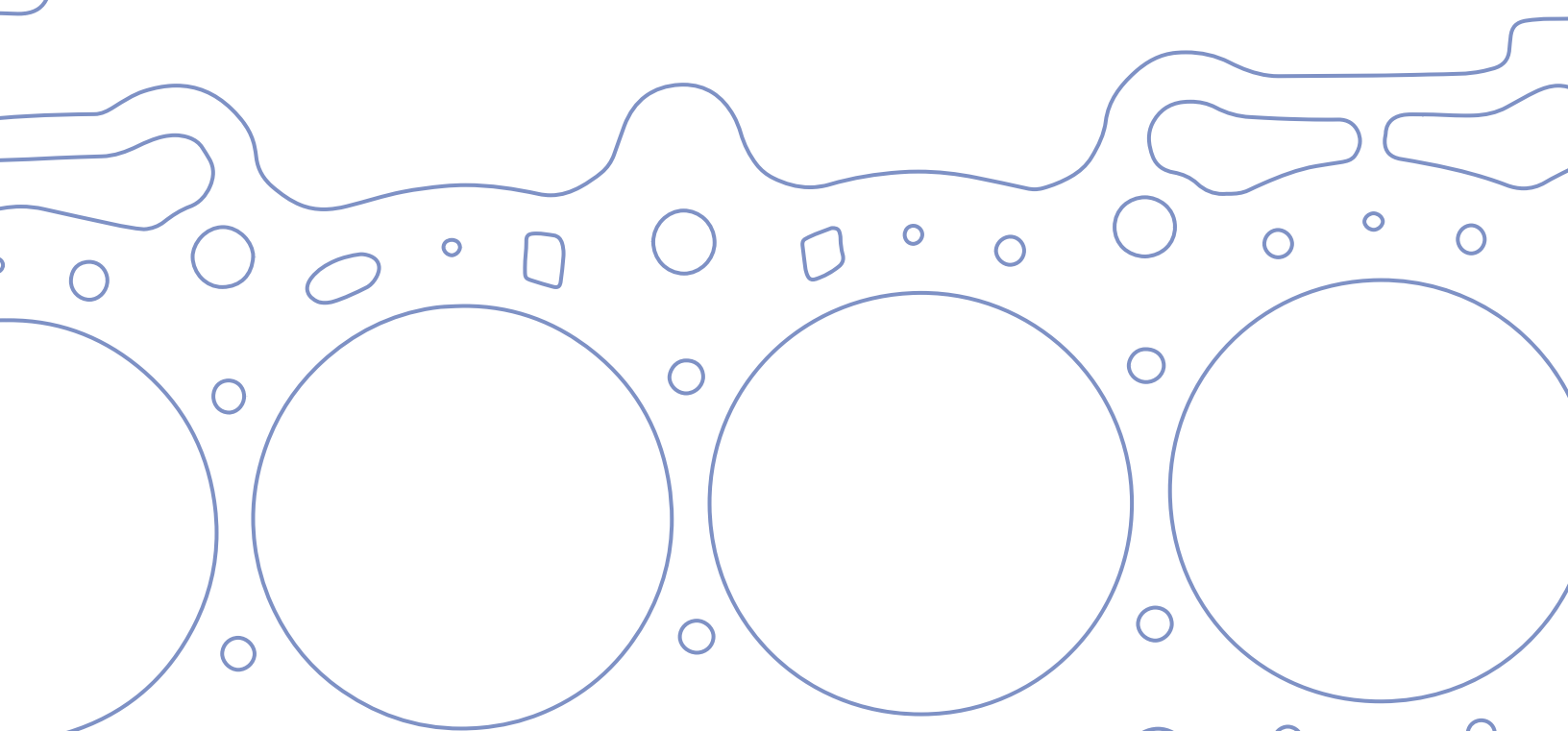



DIÁMETRO DE VÁLVULA (VÁSTAGO)

ALTURA  
TOTAL

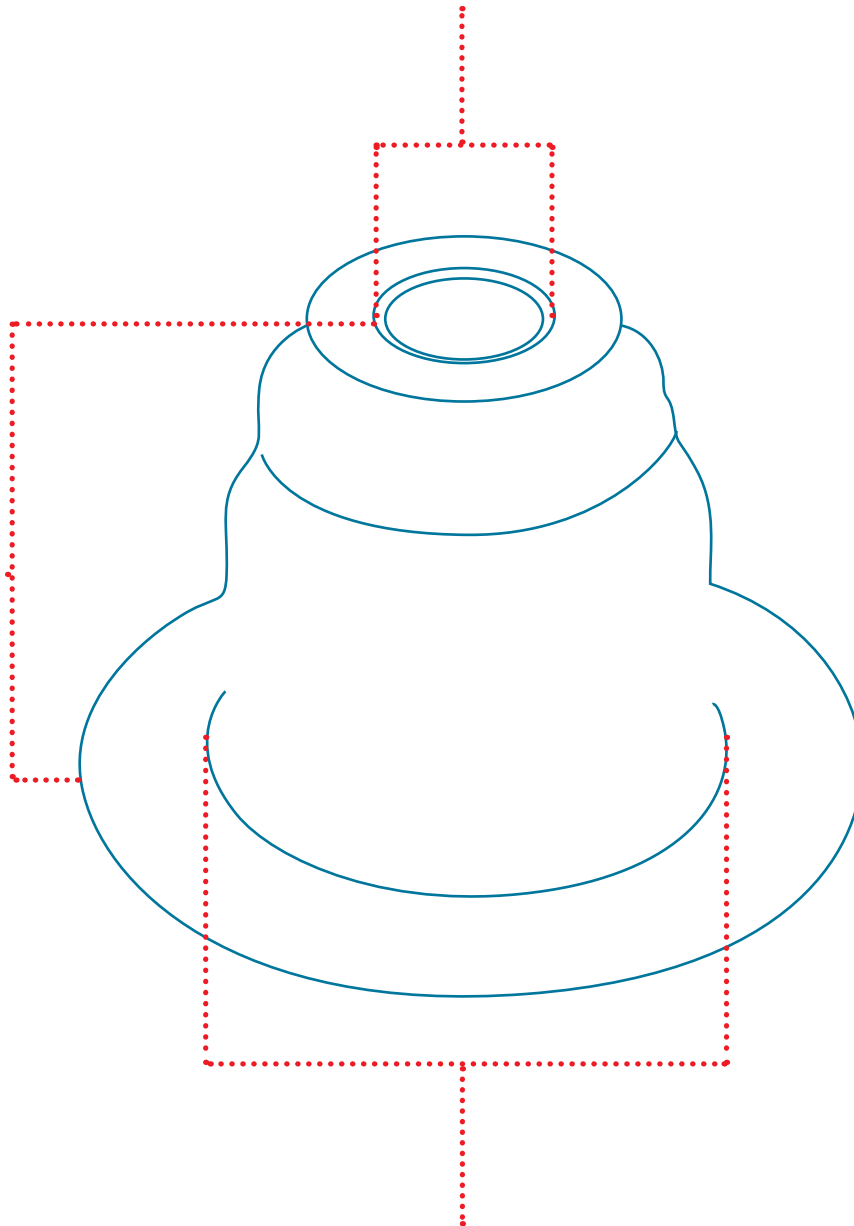



DIÁMETRO DE GUÍA INTERIOR



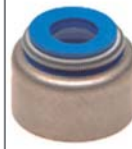

	<b>SS-8252-1V/SS-8252-V/SV-8252-V/SV-81361-V</b>		
	DIÁMETRO DE VALVULA	DIÁMETRO DE GUÍA	ALTURA
	VALVE DIAMETER	BORE GUIDE	HEIGHT
	5.3 mm.	10.8 mm.	10.7 mm.

	<b>SS-8116-R / SV-8116-S</b>		
	DIÁMETRO DE VALVULA	DIÁMETRO DE GUÍA	ALTURA
	VALVE DIAMETER	BORE GUIDE	HEIGHT
	4.6 mm.	9mm.	9.2 mm.

	<b>SV-8250-N</b>		
	DIÁMETRO DE VALVULA	DIÁMETRO DE GUÍA	ALTURA
	VALVE DIAMETER	BORE GUIDE	HEIGHT
	3.8 mm.	7.4 mm.	8.2mm.

	<b>SS-8348-V/SV-8348-V</b>		
	DIÁMETRO DE VALVULA	DIÁMETRO DE GUÍA	ALTURA
	VALVE DIAMETER	BORE GUIDE	HEIGHT
	4.7 mm.	10.8 mm.	18.1 mm.

	<b>SS-8250-1N / SS-8250-N / SS-8253</b>		
	DIÁMETRO DE VALVULA	DIÁMETRO DE GUÍA	ALTURA
	VALVE DIAMETER	BORE GUIDE	HEIGHT
	4.1 mm.	7.4 mm.	7.5 mm.

	<b>SS-8226-V / SV-8226-V</b>		
	DIÁMETRO DE VALVULA	DIÁMETRO DE GUÍA	ALTURA
	VALVE DIAMETER	BORE GUIDE	HEIGHT
	4.8 mm.	10.5 mm.	19.8 mm

	<b>SV-8114-1V</b>		
	DIÁMETRO DE VALVULA	DIÁMETRO DE GUÍA	ALTURA
	VALVE DIAMETER	BORE GUIDE	HEIGHT
	4.3 mm.	7.7 mm.	7.9 mm.

	<b>SS-81550-V / SV-81550-V</b>		
	DIÁMETRO DE VALVULA	DIÁMETRO DE GUÍA	ALTURA
	VALVE DIAMETER	BORE GUIDE	HEIGHT
	4.8 mm.	10.9 mm.	16.4 mm.

	<b>SS-8119-V / SV-8119-V</b>		
	DIÁMETRO DE VALVULA	DIÁMETRO DE GUÍA	ALTURA
	VALVE DIAMETER	BORE GUIDE	HEIGHT
	4.3 mm.	9.8 mm.	17.8 mm.

	<b>SV-81238</b>		
	DIÁMETRO DE VALVULA	DIÁMETRO DE GUÍA	ALTURA
	VALVE DIAMETER	BORE GUIDE	HEIGHT
	4.9 mm.	9.3 mm.	11.4 mm.

	<b>SS-81226-V / SV-81226-V</b>		
	DIÁMETRO DE VALVULA	DIÁMETRO DE GUÍA	ALTURA
	VALVE DIAMETER	BORE GUIDE	HEIGHT
	4.4 mm.	9.1 mm.	11.4 mm.

	<b>SS-8252-S</b>		
	DIÁMETRO DE VALVULA	DIÁMETRO DE GUÍA	ALTURA
	VALVE DIAMETER	BORE GUIDE	HEIGHT
	5 mm.	10.7 mm.	11.8 mm.
	5 mm.	10.6 mm.	10.7 mm.

	<b>SS-8122-V / SV-8122-V</b>		
	DIÁMETRO DE VALVULA	DIÁMETRO DE GUÍA	ALTURA
	VALVE DIAMETER	BORE GUIDE	HEIGHT
	4.5 mm.	7.5 mm.	15.3 mm.

	<b>SS-8357-1V / SV-8357-1V</b>		
	DIÁMETRO DE VALVULA	DIÁMETRO DE GUÍA	ALTURA
	VALVE DIAMETER	BORE GUIDE	HEIGHT
	5 mm.	10.4 mm	19.1 mm.



	SS-81452-V / SV-81452-V		
	DIÁMETRO DE VALVULA	DIÁMETRO DE GUÍA	ALTURA
	VALVE DIAMETER	BORE GUIDE	HEIGHT
	5 mm.	10.9 mm.	10 mm.

	SS-81852-V / SV-81852-V		
	DIÁMETRO DE VALVULA	DIÁMETRO DE GUÍA	ALTURA
	VALVE DIAMETER	BORE GUIDE	HEIGHT
	5.1 mm.	8.6 mm.	10 mm.

	SS-8102-1V / SV-8102-1V		
	DIÁMETRO DE VALVULA	DIÁMETRO DE GUÍA	ALTURA
	VALVE DIAMETER	BORE GUIDE	HEIGHT
	5.1 mm.	10.8 mm.	15.9 mm.

	SS-8114-V / SV-8114-V		
	DIÁMETRO DE VALVULA	DIÁMETRO DE GUÍA	ALTURA
	VALVE DIAMETER	BORE GUIDE	HEIGHT
	5.2 mm.	8.6 mm.	10 mm.

	SS-8117-V / SV-8117-V		
	DIÁMETRO DE VALVULA	DIÁMETRO DE GUÍA	ALTURA
	VALVE DIAMETER	BORE GUIDE	HEIGHT
	5.1 mm.	8.4 mm.	10.1 mm.

	SS-8153-V / SV-8153-V		
	DIÁMETRO DE VALVULA	DIÁMETRO DE GUÍA	ALTURA
	VALVE DIAMETER	BORE GUIDE	HEIGHT
	5.2 mm.	10 mm.	18.6 mm.

	SS-8252-S / SV-8252-S		
	DIÁMETRO DE VALVULA	DIÁMETRO DE GUÍA	ALTURA
	VALVE DIAMETER	BORE GUIDE	HEIGHT
	5.0 mm.	10.6 mm.	10.7 mm.
	5.1 mm.	10.7 mm.	11.8 mm.

	SS-8183-V		
	DIÁMETRO DE VALVULA	DIÁMETRO DE GUÍA	ALTURA
	VALVE DIAMETER	BORE GUIDE	HEIGHT
	5.2 mm.	10.9 mm.	19.7 mm.

	SS-8357-2V / SV-8357-2V		
	DIÁMETRO DE VALVULA	DIÁMETRO DE GUÍA	ALTURA
	VALVE DIAMETER	BORE GUIDE	HEIGHT
	5.1 mm.	10.2 mm.	17.8 mm.

	SS-81227 / SV-81227		
	DIÁMETRO DE VALVULA	DIÁMETRO DE GUÍA	ALTURA
	VALVE DIAMETER	BORE GUIDE	HEIGHT
	5.2 mm.	10.8 mm.	11 mm.
	5.2 mm.	9.8 mm.	11.5 mm.

	SS-81357-S / SV-81357-S		
	DIÁMETRO DE VALVULA	DIÁMETRO DE GUÍA	ALTURA
	VALVE DIAMETER	BORE GUIDE	HEIGHT
	5.1 mm.	11.1 mm.	11.2 mm.

	SS-8201-PA / SS-81227/SV-8201-PA/SV-81228		
	DIÁMETRO DE VALVULA	DIÁMETRO DE GUÍA	ALTURA
	VALVE DIAMETER	BORE GUIDE	HEIGHT
	5.2 mm.	9.8 mm.	11.5 mm.

	SS-81468-V		
	DIÁMETRO DE VALVULA	DIÁMETRO DE GUÍA	ALTURA
	VALVE DIAMETER	BORE GUIDE	HEIGHT
	5.1 mm.	11 mm.	10.3 mm.

	SS-8280-V / SV-8280-V		
	DIÁMETRO DE VALVULA	DIÁMETRO DE GUÍA	ALTURA
	VALVE DIAMETER	BORE GUIDE	HEIGHT
	5.3 mm.	10.7 mm.	18.2 mm.

\*\* Para ver aplicación dirigirse a catálogo electrónico: [catalogo.dcp.com.mx](http://catalogo.dcp.com.mx).





	<b>SS-8307-V / SV-8307-V</b>		
	DIÁMETRO DE VALVULA	DIÁMETRO DE GUÍA	ALTURA
	VALVE DIAMETER	BORE GUIDE	HEIGHT
	5.3 mm.	10.5 mm.	15.9 mm.

	<b>SS-8115-V</b>		
	DIÁMETRO DE VALVULA	DIÁMETRO DE GUÍA	ALTURA
	VALVE DIAMETER	BORE GUIDE	HEIGHT
	5.5 mm.	11 mm.	13 mm.

	<b>SS-81357-V / SV-81357-V</b>		
	DIÁMETRO DE VALVULA	DIÁMETRO DE GUÍA	ALTURA
	VALVE DIAMETER	BORE GUIDE	HEIGHT
	5.3 mm.	10.8 mm.	9 mm.

	<b>SV-8313-1V</b>		
	DIÁMETRO DE VALVULA	DIÁMETRO DE GUÍA	ALTURA
	VALVE DIAMETER	BORE GUIDE	HEIGHT
	5.5 mm.	11.9 mm.	20.5 mm

	<b>SS-8109-S / SS-8319-V / SV-8109-S</b>		
	DIÁMETRO DE VALVULA	DIÁMETRO DE GUÍA	ALTURA
	VALVE DIAMETER	BORE GUIDE	HEIGHT
	5.4 mm.	10.6 mm.	10.2 mm.

	<b>SS-8100-V / SV-8100-V</b>		
	DIÁMETRO DE VALVULA	DIÁMETRO DE GUÍA	ALTURA
	VALVE DIAMETER	BORE GUIDE	HEIGHT
	5.6 mm.	10.7 mm.	9.5 mm.

	<b>SS-8311-V / SV-8311-V</b>		
	DIÁMETRO DE VALVULA	DIÁMETRO DE GUÍA	ALTURA
	VALVE DIAMETER	BORE GUIDE	HEIGHT
	5.4 mm.	12.2 mm.	18.8 mm.

	<b>SS-8113-V / SV-8113-V</b>		
	DIÁMETRO DE VALVULA	DIÁMETRO DE GUÍA	ALTURA
	VALVE DIAMETER	BORE GUIDE	HEIGHT
	5.7 mm.	9.9 mm.	15.3 mm.

	<b>SS-81236-V</b>		
	DIÁMETRO DE VALVULA	DIÁMETRO DE GUÍA	ALTURA
	VALVE DIAMETER	BORE GUIDE	HEIGHT
	5.4 mm.	9.9 mm.	11.3 mm.

	<b>SS-8133-V</b>		
	DIÁMETRO DE VALVULA	DIÁMETRO DE GUÍA	ALTURA
	VALVE DIAMETER	BORE GUIDE	HEIGHT
	5.7 mm.	10.9 mm.	9.7 mm.

	<b>SS-81305</b>		
	DIÁMETRO DE VALVULA	DIÁMETRO DE GUÍA	ALTURA
	VALVE DIAMETER	BORE GUIDE	HEIGHT
	5.4 mm.	11 mm.	9.1 mm.

	<b>SS-8242-V / SV-8242-V</b>		
	DIÁMETRO DE VALVULA	DIÁMETRO DE GUÍA	ALTURA
	VALVE DIAMETER	BORE GUIDE	HEIGHT
	5.7 mm.	11.1 mm	18.4 mm.

	<b>SS-8103-V / SV-8103-V</b>		
	DIÁMETRO DE VALVULA	DIÁMETRO DE GUÍA	ALTURA
	VALVE DIAMETER	BORE GUIDE	HEIGHT
	5.5 mm.	11.5 mm.	9.5 mm.

	<b>SS-8317-V / SV-8317-V</b>		
	DIÁMETRO DE VALVULA	DIÁMETRO DE GUÍA	ALTURA
	VALVE DIAMETER	BORE GUIDE	HEIGHT
	5.8 mm.	11 mm	18 mm.



	<b>SS-81467-V</b>		
	DIÁMETRO DE VALVULA	DIÁMETRO DE GUÍA	ALTURA
	VALVE DIAMETER	BORE GUIDE	HEIGHT
	6.0 mm.	9.3 mm.	8.6 mm.
	5.8 mm.	11.8 mm.	9.7 mm.

	<b>SS-81225-1 / SS-81229</b>		
	DIÁMETRO DE VALVULA	DIÁMETRO DE GUÍA	ALTURA
	VALVE DIAMETER	BORE GUIDE	HEIGHT
	6 mm.	10.6 mm.	12.6 mm.

	<b>SV-81845-V</b>		
	DIÁMETRO DE VALVULA	DIÁMETRO DE GUÍA	ALTURA
	VALVE DIAMETER	BORE GUIDE	HEIGHT
	5.9 mm.	9.5 mm.	9.9 mm.

	<b>SS-8112-V / SV-8112-V</b>		
	DIÁMETRO DE VALVULA	DIÁMETRO DE GUÍA	ALTURA
	VALVE DIAMETER	BORE GUIDE	HEIGHT
	6.1 mm.	12.7 mm.	20.2 mm.

	<b>SS-8230-PA / SV-8230-PA</b>		
	DIÁMETRO DE VALVULA	DIÁMETRO DE GUÍA	ALTURA
	VALVE DIAMETER	BORE GUIDE	HEIGHT
	6 mm.	11.6 mm.	11.9 mm.

	<b>SS-8249-V / SV-8249-V</b>		
	DIÁMETRO DE VALVULA	DIÁMETRO DE GUÍA	ALTURA
	VALVE DIAMETER	BORE GUIDE	HEIGHT
	6.1 mm.	12.5 mm.	16 mm.

	<b>SS-8268-V / SV-8268-V</b>		
	DIÁMETRO DE VALVULA	DIÁMETRO DE GUÍA	ALTURA
	VALVE DIAMETER	BORE GUIDE	HEIGHT
	6 mm.	11.1 mm.	16.8 mm.

	<b>SS-8302-V</b>		
	DIÁMETRO DE VALVULA	DIÁMETRO DE GUÍA	ALTURA
	VALVE DIAMETER	BORE GUIDE	HEIGHT
	6.1 mm.	9.6 mm.	9.7 mm.

	<b>SS-8341-V / SV-8341-V</b>		
	DIÁMETRO DE VALVULA	DIÁMETRO DE GUÍA	ALTURA
	VALVE DIAMETER	BORE GUIDE	HEIGHT
	6 mm.	12.6 mm.	21.5 mm.

	<b>SS-8337-V / SV-8337-V</b>		
	DIÁMETRO DE VALVULA	DIÁMETRO DE GUÍA	ALTURA
	VALVE DIAMETER	BORE GUIDE	HEIGHT
	6.1 mm.	11.7 mm.	16.3 mm.

	<b>SS-8341-1V / SV-8341-1V (Base grande)</b>		
	DIÁMETRO DE VALVULA	DIÁMETRO DE GUÍA	ALTURA
	VALVE DIAMETER	BORE GUIDE	HEIGHT
	6 mm.	12.7 mm.	21 mm.

	<b>SV-81225-V</b>		
	DIÁMETRO DE VALVULA	DIÁMETRO DE GUÍA	ALTURA
	VALVE DIAMETER	BORE GUIDE	HEIGHT
	6.1 mm.	10.6 mm.	10.7 mm.

	<b>SS-81216 / SV-81216</b>		
	DIÁMETRO DE VALVULA	DIÁMETRO DE GUÍA	ALTURA
	VALVE DIAMETER	BORE GUIDE	HEIGHT
	6 mm.	11.6 mm.	14.8 mm.

	<b>SS-81303-N</b>		
	DIÁMETRO DE VALVULA	DIÁMETRO DE GUÍA	ALTURA
	VALVE DIAMETER	BORE GUIDE	HEIGHT
	6.1 mm.	11.4 mm.	9.5 mm.

\*\* Para ver aplicación dirigirse a catálogo electrónico: [catalogo.dcp.com.mx](http://catalogo.dcp.com.mx).





	<b>SV-8262-V</b>		
	DIÁMETRO DE VALVULA	DIÁMETRO DE GUÍA	ALTURA
	VALVE DIAMETER	BORE GUIDE	HEIGHT
	6.2 mm.	11 mm.	17 mm.

	<b>SS-8271-12V / SS-8271-1V / SV-8271-V</b>		
	DIÁMETRO DE VALVULA	DIÁMETRO DE GUÍA	ALTURA
	VALVE DIAMETER	BORE GUIDE	HEIGHT
	6.4 mm.	11.7 mm.	18.7 mm.

	<b>SS-81240-PA / SV-81240-PA</b>		
	DIÁMETRO DE VALVULA	DIÁMETRO DE GUÍA	ALTURA
	VALVE DIAMETER	BORE GUIDE	HEIGHT
	6.2 mm.	10.8 mm.	11.7 mm.

	<b>SV-8303-P</b>		
	DIÁMETRO DE VALVULA	DIÁMETRO DE GUÍA	ALTURA
	VALVE DIAMETER	BORE GUIDE	HEIGHT
	6.4 mm.	11.5 mm.	9.1 mm.

	<b>SS-8108-V / SV-8108-V</b>		
	DIÁMETRO DE VALVULA	DIÁMETRO DE GUÍA	ALTURA
	VALVE DIAMETER	BORE GUIDE	HEIGHT
	6.3 mm.	11.4 mm.	12 mm.

	<b>SV-81216-V</b>		
	DIÁMETRO DE VALVULA	DIÁMETRO DE GUÍA	ALTURA
	VALVE DIAMETER	BORE GUIDE	HEIGHT
	6.4 mm.	11.7 mm.	15.2 mm

	<b>SS-8111-S / SV-8111-S</b>		
	DIÁMETRO DE VALVULA	DIÁMETRO DE GUÍA	ALTURA
	VALVE DIAMETER	BORE GUIDE	HEIGHT
	6.3 mm.	11.6 mm.	18.6 mm.

	<b>SS-8111-V</b>		
	DIÁMETRO DE VALVULA	DIÁMETRO DE GUÍA	ALTURA
	VALVE DIAMETER	BORE GUIDE	HEIGHT
	6.5 mm.	11.1 mm.	14.2 mm.

	<b>SS-8356-V / SV-8356-V</b>		
	DIÁMETRO DE VALVULA	DIÁMETRO DE GUÍA	ALTURA
	VALVE DIAMETER	BORE GUIDE	HEIGHT
	6.3 mm.	10.6 mm.	20.5 mm.

	<b>SS-8250-V / SV-8250-V</b>		
	DIÁMETRO DE VALVULA	DIÁMETRO DE GUÍA	ALTURA
	VALVE DIAMETER	BORE GUIDE	HEIGHT
	6.8 mm.	12.8 mm.	12.9 mm.

	<b>SS-8357-V / SV-8357-V</b>		
	DIÁMETRO DE VALVULA	DIÁMETRO DE GUÍA	ALTURA
	VALVE DIAMETER	BORE GUIDE	HEIGHT
	6.3mm.	12 mm.	20.1 mm.

	<b>SV-8335-V</b>		
	DIÁMETRO DE VALVULA	DIÁMETRO DE GUÍA	ALTURA
	VALVE DIAMETER	BORE GUIDE	HEIGHT
	6.8 mm.	11.7 mm.	8.6 mm.

	<b>SS-8109-1V / SS-8109-V / SV-8109-1V</b>		
	DIÁMETRO DE VALVULA	DIÁMETRO DE GUÍA	ALTURA
	VALVE DIAMETER	BORE GUIDE	HEIGHT
	6.4 mm.	12.9 mm.	12.9 mm.

	<b>SS-8110 / SS-8180-V / SV-8110</b>		
	DIÁMETRO DE VALVULA	DIÁMETRO DE GUÍA	ALTURA
	VALVE DIAMETER	BORE GUIDE	HEIGHT
	0.7 mm.		0.2 mm.



	<b>SS-8145-V / SV-8145-V</b>		
	DIÁMETRO DE VALVULA	DIÁMETRO DE GUÍA	ALTURA
	VALVE DIAMETER	BORE GUIDE	HEIGHT
	7 mm.	13.9 mm.	22.9 mm.

	<b>SS-81120-V / SV-81120-V</b>		
	DIÁMETRO DE VALVULA	DIÁMETRO DE GUÍA	ALTURA
	VALVE DIAMETER	BORE GUIDE	HEIGHT
	7.1 mm.	12.7 mm.	9.9 mm.

	<b>SS-8240-1V / SV-8240-1V</b>		
	DIÁMETRO DE VALVULA	DIÁMETRO DE GUÍA	ALTURA
	VALVE DIAMETER	BORE GUIDE	HEIGHT
	7mm.	10.8 mm.	13.7 mm.

	<b>SS-81218 / SS-81225-1 / SS-81229 / SV-81218</b>		
	DIÁMETRO DE VALVULA	DIÁMETRO DE GUÍA	ALTURA
	VALVE DIAMETER	BORE GUIDE	HEIGHT
	7.1 mm.	11.3 mm.	14.3 mm.

	<b>SS-81210 / SV-81210</b>		
	DIÁMETRO DE VALVULA	DIÁMETRO DE GUÍA	ALTURA
	VALVE DIAMETER	BORE GUIDE	HEIGHT
	7 mm.	14.1 mm.	20.9 mm.

	<b>SS-81321-N</b>		
	DIÁMETRO DE VALVULA	DIÁMETRO DE GUÍA	ALTURA
	VALVE DIAMETER	BORE GUIDE	HEIGHT
	7.1 mm.	12.8 mm.	10 mm

	<b>SS-81215 / SV-81215</b>		
	DIÁMETRO DE VALVULA	DIÁMETRO DE GUÍA	ALTURA
	VALVE DIAMETER	BORE GUIDE	HEIGHT
	7 mm.	11.8 mm.	13.5 mm.

	<b>SS-8301-V / SV-8301-V</b>		
	DIÁMETRO DE VALVULA	DIÁMETRO DE GUÍA	ALTURA
	VALVE DIAMETER	BORE GUIDE	HEIGHT
	7.2 mm.	11.9 mm.	17.9 mm.

	<b>SS-81830 / SV-81830</b>		
	DIÁMETRO DE VALVULA	DIÁMETRO DE GUÍA	ALTURA
	VALVE DIAMETER	BORE GUIDE	HEIGHT
	7 mm.	10.6 mm.	10.4 mm.

	<b>SV-8304</b>		
	DIÁMETRO DE VALVULA	DIÁMETRO DE GUÍA	ALTURA
	VALVE DIAMETER	BORE GUIDE	HEIGHT
	7.2 mm.	12.7 mm.	13.2 mm.

	<b>SS-8141-V / SV-8141-V</b>		
	DIÁMETRO DE VALVULA	DIÁMETRO DE GUÍA	ALTURA
	VALVE DIAMETER	BORE GUIDE	HEIGHT
	7.1 mm.	11.4 mm.	12.2 mm.

	<b>SS-81350-V</b>		
	DIÁMETRO DE VALVULA	DIÁMETRO DE GUÍA	ALTURA
	VALVE DIAMETER	BORE GUIDE	HEIGHT
	7.2 mm.	12.6 mm.	10 mm.
	7.9 mm.	12.2 mm.	13.2 mm.

	<b>SS-8304-V / SV-81110</b>		
	DIÁMETRO DE VALVULA	DIÁMETRO DE GUÍA	ALTURA
	VALVE DIAMETER	BORE GUIDE	HEIGHT
	7.1 mm.	13.9 mm.	13 mm.

	<b>SV-50</b>		
	DIÁMETRO DE VALVULA	DIÁMETRO DE GUÍA	ALTURA
	VALVE DIAMETER	BORE GUIDE	HEIGHT
	7.3 mm.	12.5 mm.	11.5 mm.

\*\* Para ver aplicación dirigirse a catálogo electrónico: [catalogo.dcp.com.mx](http://catalogo.dcp.com.mx).





	<b>SS-8152-V / SV-8152-V</b>		
	DIÁMETRO DE VALVULA	DIÁMETRO DE GUÍA	ALTURA
	VALVE DIAMETER	BORE GUIDE	HEIGHT
	7.3 mm.	12.1 mm.	14 mm.

	<b>SS-8396-1V</b>		
	DIÁMETRO DE VALVULA	DIÁMETRO DE GUÍA	ALTURA
	VALVE DIAMETER	BORE GUIDE	HEIGHT
	7.4 mm.	14 mm.	28.1 mm.

	<b>SS-8240-N / SV-8240-N</b>		
	DIÁMETRO DE VALVULA	DIÁMETRO DE GUÍA	ALTURA
	VALVE DIAMETER	BORE GUIDE	HEIGHT
	7.3 mm.	10.9 mm.	13.7 mm.

	<b>SS-8105-V / SV-8105-V</b>				
	DIÁMETRO DE VALVULA	DIÁMETRO DE GUÍA	ALTURA		
	VALVE DIAMETER	BORE GUIDE	HEIGHT		
	7.4 mm.	10.5 mm.	11.1 mm.		
			7.5 mm.	10.9 mm.	11.2 mm.

	<b>SS-8273-V / SV-8273-V</b>		
	DIÁMETRO DE VALVULA	DIÁMETRO DE GUÍA	ALTURA
	VALVE DIAMETER	BORE GUIDE	HEIGHT
	7.3 mm.	13.7 mm.	26.3 mm.

	<b>SS-8240-S / SV-8240-S</b>		
	DIÁMETRO DE VALVULA	DIÁMETRO DE GUÍA	ALTURA
	VALVE DIAMETER	BORE GUIDE	HEIGHT
	7.5 mm.	11.1 mm.	13.5 mm

	<b>SS-81310-N / SV-81310-N</b>		
	DIÁMETRO DE VALVULA	DIÁMETRO DE GUÍA	ALTURA
	VALVE DIAMETER	BORE GUIDE	HEIGHT
	7.3 mm.	12.8 mm.	9.7 mm.

	<b>SS-8240-V / SV-8240-V</b>		
	DIÁMETRO DE VALVULA	DIÁMETRO DE GUÍA	ALTURA
	VALVE DIAMETER	BORE GUIDE	HEIGHT
	7.5 mm.	10.9 mm.	13.6 mm.

	<b>SS-8105-V</b>				
	DIÁMETRO DE VALVULA	DIÁMETRO DE GUÍA	ALTURA		
	VALVE DIAMETER	BORE GUIDE	HEIGHT		
	7.4 mm.	10.5 mm.	11.1 mm.		
			7.5 mm.	10.9 mm.	11.2 mm.

	<b>SS-8140-12P/SS-8140-16P/SS-8140-8P/SV-8140-P</b>		
	DIÁMETRO DE VALVULA	DIÁMETRO DE GUÍA	ALTURA
	VALVE DIAMETER	BORE GUIDE	HEIGHT
	7.6 mm.	12 mm.	12.1 mm.

	<b>SS-8152-1V / SV-8152-1V</b>		
	DIÁMETRO DE VALVULA	DIÁMETRO DE GUÍA	ALTURA
	VALVE DIAMETER	BORE GUIDE	HEIGHT
	7.4 mm.	12.5 mm.	22.6 mm.

	<b>SS-8160-12V / SS-8160-16V / SV-8160-V</b>		
	DIÁMETRO DE VALVULA	DIÁMETRO DE GUÍA	ALTURA
	VALVE DIAMETER	BORE GUIDE	HEIGHT
	7.6 mm.	13.9 mm.	13.47 mm.

	<b>SS-8270-V / SV-8270-V</b>		
	DIÁMETRO DE VALVULA	DIÁMETRO DE GUÍA	ALTURA
	VALVE DIAMETER	BORE GUIDE	HEIGHT
	7.4 mm.	13.2 mm.	13 mm.

	<b>SS-8365 / SV-8365</b>		
	DIÁMETRO DE VALVULA	DIÁMETRO DE GUÍA	ALTURA
	VALVE DIAMETER	BORE GUIDE	HEIGHT
	7.7 mm.	17.5 mm.	18.2 mm.



	<b>SS-8220-A / SV-8220-A</b>		
	DIÁMETRO DE VALVULA	DIÁMETRO DE GUÍA	ALTURA
	VALVE DIAMETER	BORE GUIDE	HEIGHT
	7.7 mm.	18 mm.	17.3 mm.

	<b>SS-8310 / SV-8310</b>		
	DIÁMETRO DE VALVULA	DIÁMETRO DE GUÍA	ALTURA
	VALVE DIAMETER	BORE GUIDE	HEIGHT
	8 mm.	18 mm.	10 mm.

	<b>SS-8150-12V/SS-8150-16V/SS-8150-8V/SS-8330-1V/SV-8150-V</b>		
	DIÁMETRO DE VALVULA	DIÁMETRO DE GUÍA	ALTURA
	VALVE DIAMETER	BORE GUIDE	HEIGHT
	7.9 mm.	12 mm.	12 mm.

	<b>SS-8710 / SV-8710</b>		
	DIÁMETRO DE VALVULA	DIÁMETRO DE GUÍA	ALTURA
	VALVE DIAMETER	BORE GUIDE	HEIGHT
	8 mm.	19.8 mm.	17.3 mm.

	<b>SS-8313-V / SV-8313-V</b>		
	DIÁMETRO DE VALVULA	DIÁMETRO DE GUÍA	ALTURA
	VALVE DIAMETER	BORE GUIDE	HEIGHT
	5.7 mm.	11.8 mm.	20.2 mm.

	<b>SV-50-S</b>		
	DIÁMETRO DE VALVULA	DIÁMETRO DE GUÍA	ALTURA
	VALVE DIAMETER	BORE GUIDE	HEIGHT
	8.1 mm.	13.7 mm.	11.5 mm.

	<b>SS-8330 / SV-8330</b>		
	DIÁMETRO DE VALVULA	DIÁMETRO DE GUÍA	ALTURA
	VALVE DIAMETER	BORE GUIDE	HEIGHT
	7.9 mm.	12.4 mm.	13.1 mm.

	<b>SS-8180-V</b>		
	DIÁMETRO DE VALVULA	DIÁMETRO DE GUÍA	ALTURA
	VALVE DIAMETER	BORE GUIDE	HEIGHT
	8.1 mm.	14.8 mm.	10.2 mm.

	<b>SS-8150-1P</b>		
	DIÁMETRO DE VALVULA	DIÁMETRO DE GUÍA	ALTURA
	VALVE DIAMETER	BORE GUIDE	HEIGHT
	8 mm.	16.1 mm.	14 mm.

	<b>SS-8520 / SV-8520</b>		
	DIÁMETRO DE VALVULA	DIÁMETRO DE GUÍA	ALTURA
	VALVE DIAMETER	BORE GUIDE	HEIGHT
	8.1 mm.	16.1 mm.	19 mm.

	<b>SS-8330-V / SV-8330-V</b>		
	DIÁMETRO DE VALVULA	DIÁMETRO DE GUÍA	ALTURA
	VALVE DIAMETER	BORE GUIDE	HEIGHT
	8 mm.	12.3 mm.	13.5 mm.

	<b>SS-8355 / SV-8355</b>		
	DIÁMETRO DE VALVULA	DIÁMETRO DE GUÍA	ALTURA
	VALVE DIAMETER	BORE GUIDE	HEIGHT
	8.1 mm.	18.1 mm.	19.3 mm.

	<b>SV-8250-N</b>		
	DIÁMETRO DE VALVULA	DIÁMETRO DE GUÍA	ALTURA
	VALVE DIAMETER	BORE GUIDE	HEIGHT
	3.8 mm.	7.4	8.2 mm.

	<b>SS-8300 / SS-8330-1V / SV-8300</b>		
	DIÁMETRO DE VALVULA	DIÁMETRO DE GUÍA	ALTURA
	VALVE DIAMETER	BORE GUIDE	HEIGHT
	8.2 mm.	12.5 mm.	11.8 mm.

\*\* Para ver aplicación dirigirse a catálogo electrónico: [catalogo.dcp.com.mx](http://catalogo.dcp.com.mx).



	<b>SS-8260 / SS-8260-1 / SV-8260</b>		
	DIÁMETRO DE VALVULA	DIÁMETRO DE GUÍA	ALTURA
	VALVE DIAMETER	BORE GUIDE	HEIGHT
	8.2 mm.	13.8 mm.	13.4 mm.
	9.2 mm.	19 mm.	6.3 mm.

	<b>SS-8164-N</b>		
	DIÁMETRO DE VALVULA	DIÁMETRO DE GUÍA	ALTURA
	VALVE DIAMETER	BORE GUIDE	HEIGHT
	8.9 mm.	14.9 mm.	11.3 mm

	<b>SS-8331-1V / SS-8331-V / SV-8305-1V</b>		
	DIÁMETRO DE VALVULA	DIÁMETRO DE GUÍA	ALTURA
	VALVE DIAMETER	BORE GUIDE	HEIGHT
	8.2 mm.	13.8 mm.	15 mm.

	<b>SS-8220-E / SS-8260-1 / SV-8220-E</b>		
	DIÁMETRO DE VALVULA	DIÁMETRO DE GUÍA	ALTURA
	VALVE DIAMETER	BORE GUIDE	HEIGHT
	8.2 mm.	13.8 mm.	13.4 mm.
	9.2 mm.	19 mm.	6.3 mm.

	<b>SS-8305-12V / SS-8305-16V / SS-8305-8V / SV-8305-V</b>		
	DIÁMETRO DE VALVULA	DIÁMETRO DE GUÍA	ALTURA
	VALVE DIAMETER	BORE GUIDE	HEIGHT
	8.2 mm.	13.9 mm.	14.9 mm.

	<b>SS-8396-V</b>		
	DIÁMETRO DE VALVULA	DIÁMETRO DE GUÍA	ALTURA
	VALVE DIAMETER	BORE GUIDE	HEIGHT
	9.2 mm.	19.4 mm.	13.8 mm.
	8.5 mm.	14.2 mm.	12.1 mm.

	<b>SS-86000 / SV-86000</b>		
	DIÁMETRO DE VALVULA	DIÁMETRO DE GUÍA	ALTURA
	VALVE DIAMETER	BORE GUIDE	HEIGHT
	8.2 mm.	15.6 mm.	12.4 mm.

	<b>SS-8167-NV / SS-8167-V / SV-8167-NV</b>		
	DIÁMETRO DE VALVULA	DIÁMETRO DE GUÍA	ALTURA
	VALVE DIAMETER	BORE GUIDE	HEIGHT
	8.3 mm.	19.6 mm.	20.5 mm.

	<b>SS-8261-1V / SV-8261-V</b>		
	DIÁMETRO DE VALVULA	DIÁMETRO DE GUÍA	ALTURA
	VALVE DIAMETER	BORE GUIDE	HEIGHT
	8.6 mm.	15.9 mm.	17.5 mm.

	<b>SS-8181-V / SV-8181-V</b>		
	DIÁMETRO DE VALVULA	DIÁMETRO DE GUÍA	ALTURA
	VALVE DIAMETER	BORE GUIDE	HEIGHT
	8.7 mm.	15.3 mm.	12.9 mm.





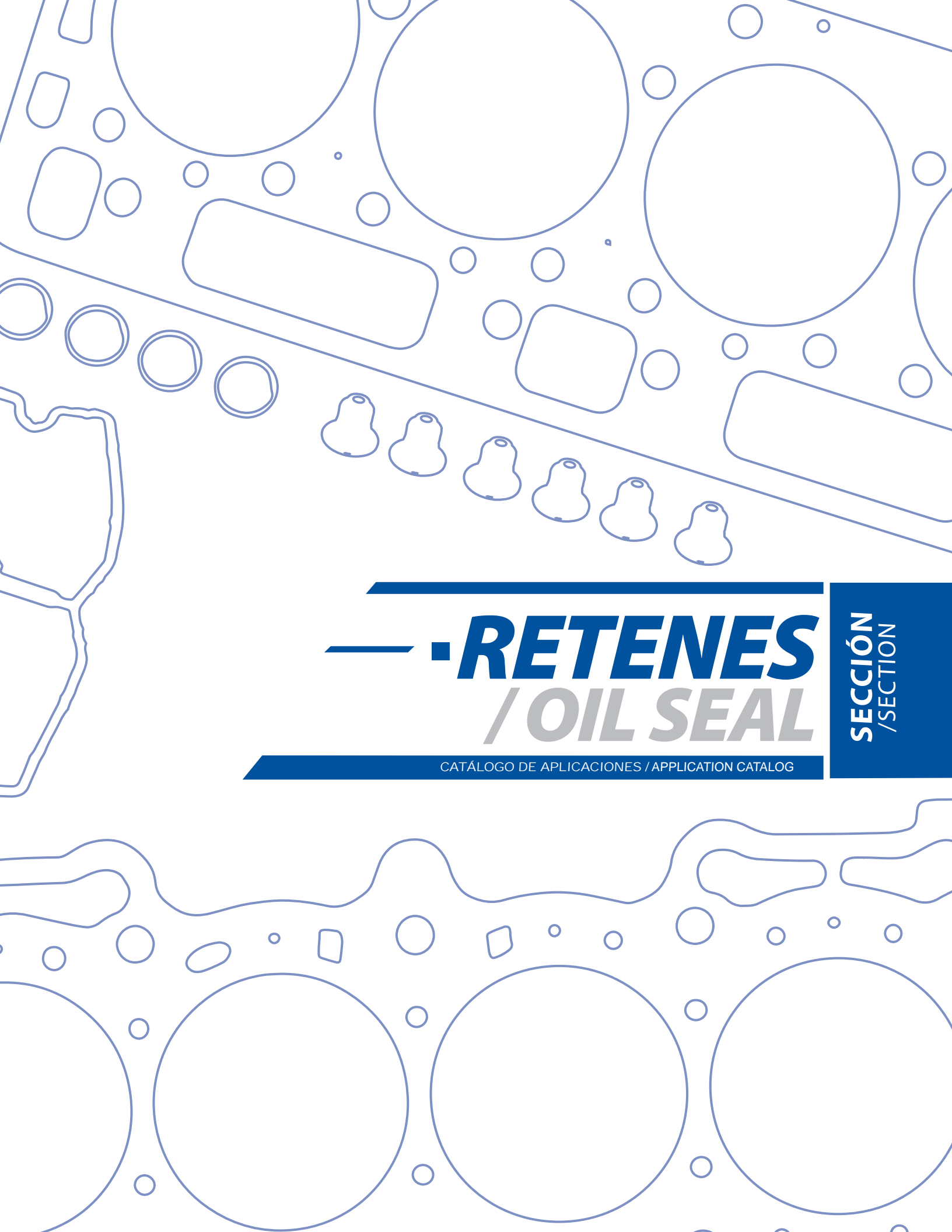

# **RETENES** **/ OIL SEAL**

**SECCIÓN**  
**/SECTION**

CATÁLOGO DE APLICACIONES / APPLICATION CATALOG



DIÁMETRO EXTERIOR

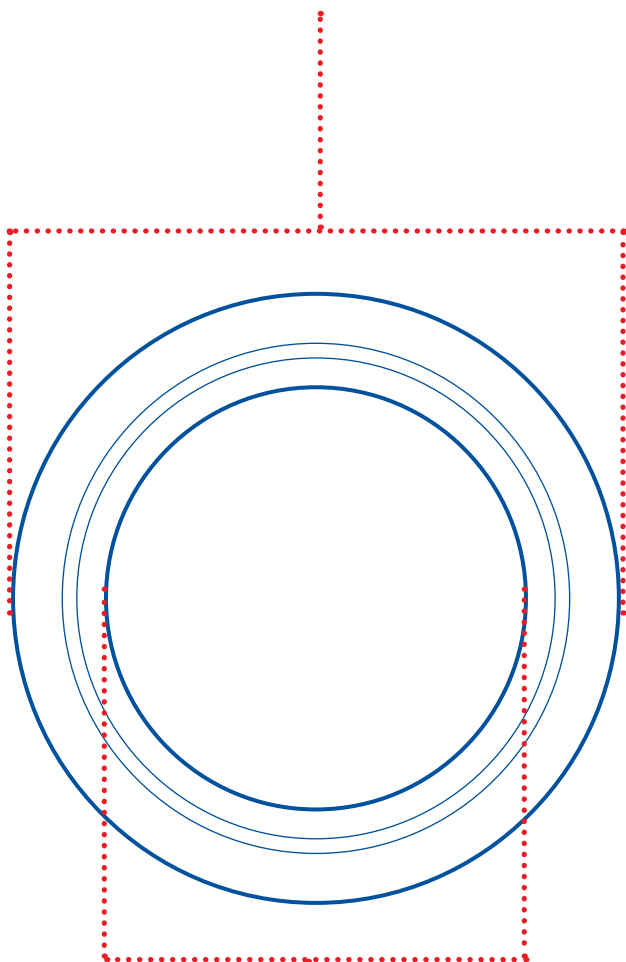

DIÁMETRO INTERIOR

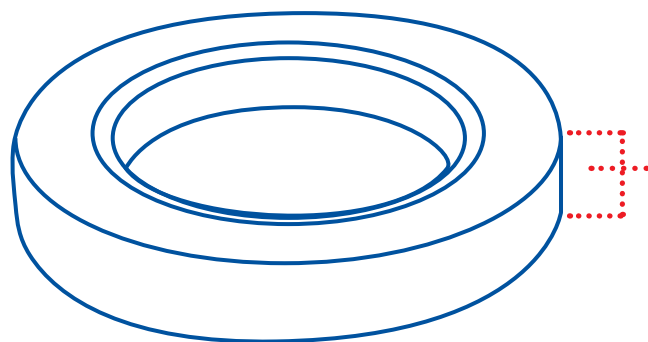

ALTURA



	<b>RE-161550-2</b>		
	DIÁMETRO INTERIOR	DIÁMETRO EXTERIOR	ALTURA
	INSIDE DIAMETER	EXTERNAL DIAMETER	HEIGHT
	0 mm.	43 mm.	9.5 mm.

	<b>RE-16014</b>		
	DIÁMETRO INTERIOR	DIÁMETRO EXTERIOR	ALTURA
	INSIDE DIAMETER	EXTERNAL DIAMETER	HEIGHT
	35 mm.	53.5 mm.	8 mm.

	<b>RE-161550-3</b>		
	DIÁMETRO INTERIOR	DIÁMETRO EXTERIOR	ALTURA
	INSIDE DIAMETER	EXTERNAL DIAMETER	HEIGHT
	0 mm.	57mm.	10.5 mm

	<b>RE-16015</b>		
	DIÁMETRO INTERIOR	DIÁMETRO EXTERIOR	ALTURA
	INSIDE DIAMETER	EXTERNAL DIAMETER	HEIGHT
	35 mm.	52 mm.	8 mm.

	<b>RE-161550</b>		
	DIÁMETRO INTERIOR	DIÁMETRO EXTERIOR	ALTURA
	INSIDE DIAMETER	EXTERNAL DIAMETER	HEIGHT
	28 mm.	42 mm.	6 mm.

	<b>RE-16253-1</b>		
	DIÁMETRO INTERIOR	DIÁMETRO EXTERIOR	ALTURA
	INSIDE DIAMETER	EXTERNAL DIAMETER	HEIGHT
	35 mm.	50 mm.	8 mm.

	<b>RE-16005</b>		
	DIÁMETRO INTERIOR	DIÁMETRO EXTERIOR	ALTURA
	INSIDE DIAMETER	EXTERNAL DIAMETER	HEIGHT
	32 mm.	50 mm.	8 mm.

	<b>RE-16073</b>		
	DIÁMETRO INTERIOR	DIÁMETRO EXTERIOR	ALTURA
	INSIDE DIAMETER	EXTERNAL DIAMETER	HEIGHT
	35 mm.	48 mm.	7 mm.

	<b>RE-16010</b>		
	DIÁMETRO INTERIOR	DIÁMETRO EXTERIOR	ALTURA
	INSIDE DIAMETER	EXTERNAL DIAMETER	HEIGHT
	32 mm.	47 mm.	10 mm.

	<b>RE-161550-1</b>		
	DIÁMETRO INTERIOR	DIÁMETRO EXTERIOR	ALTURA
	INSIDE DIAMETER	EXTERNAL DIAMETER	HEIGHT
	35 mm.	47 mm.	7 mm.

	<b>RE-16116</b>		
	DIÁMETRO INTERIOR	DIÁMETRO EXTERIOR	ALTURA
	INSIDE DIAMETER	EXTERNAL DIAMETER	HEIGHT
	32 mm.	47 mm.	6 mm.

	<b>RE-16110-S</b>		
	DIÁMETRO INTERIOR	DIÁMETRO EXTERIOR	ALTURA
	INSIDE DIAMETER	EXTERNAL DIAMETER	HEIGHT
	35 mm.	49.5 mm.	7 mm.

	<b>RE-16089-R / RE-161229</b>		
	DIÁMETRO INTERIOR	DIÁMETRO EXTERIOR	ALTURA
	INSIDE DIAMETER	EXTERNAL DIAMETER	HEIGHT
	34 mm.	48 mm.	7 mm.

	<b>RE-16313-S1</b>		
	DIÁMETRO INTERIOR	DIÁMETRO EXTERIOR	ALTURA
	INSIDE DIAMETER	EXTERNAL DIAMETER	HEIGHT
	35 mm.	50 mm.	7 mm.



RE-16006		
DIÁMETRO INTERIOR	DIÁMETRO EXTERIOR	ALTURA
INSIDE DIAMETER	EXTERNAL DIAMETER	HEIGHT
36 mm.	49 mm.	9 mm.



RE-16018		
DIÁMETRO INTERIOR	DIÁMETRO EXTERIOR	ALTURA
INSIDE DIAMETER	EXTERNAL DIAMETER	HEIGHT
43.41 mm.	56 mm.	9 mm.



RE-16253		
DIÁMETRO INTERIOR	DIÁMETRO EXTERIOR	ALTURA
INSIDE DIAMETER	EXTERNAL DIAMETER	HEIGHT
37 mm.	50 mm.	6 mm.



RE-16001		
DIÁMETRO INTERIOR	DIÁMETRO EXTERIOR	ALTURA
INSIDE DIAMETER	EXTERNAL DIAMETER	HEIGHT
44.83 mm.	61.26 mm.	9.53 mm.



RE-16007		
DIÁMETRO INTERIOR	DIÁMETRO EXTERIOR	ALTURA
INSIDE DIAMETER	EXTERNAL DIAMETER	HEIGHT
40 mm.	55 mm.	8 mm.



RE-16076-K		
DIÁMETRO INTERIOR	DIÁMETRO EXTERIOR	ALTURA
INSIDE DIAMETER	EXTERNAL DIAMETER	HEIGHT
45 mm.	62 mm.	10 mm.l



RE-16077		
DIÁMETRO INTERIOR	DIÁMETRO EXTERIOR	ALTURA
INSIDE DIAMETER	EXTERNAL DIAMETER	HEIGHT
40 mm.	52 mm.	9 mm.



RE-16221-V		
DIÁMETRO INTERIOR	DIÁMETRO EXTERIOR	ALTURA
INSIDE DIAMETER	EXTERNAL DIAMETER	HEIGHT
45 mm.	67 mm.	8 mm.



RE-16317-V		
DIÁMETRO INTERIOR	DIÁMETRO EXTERIOR	ALTURA
INSIDE DIAMETER	EXTERNAL DIAMETER	HEIGHT
40 mm.	62 mm.	7 mm.



RE-161225		
DIÁMETRO INTERIOR	DIÁMETRO EXTERIOR	ALTURA
INSIDE DIAMETER	EXTERNAL DIAMETER	HEIGHT
46 mm.	58 mm.	7 mm.



RE-16031-R		
DIÁMETRO INTERIOR	DIÁMETRO EXTERIOR	ALTURA
INSIDE DIAMETER	EXTERNAL DIAMETER	HEIGHT
42 mm.	56 mm.	7 mm.



RE-16356-N		
DIÁMETRO INTERIOR	DIÁMETRO EXTERIOR	ALTURA
INSIDE DIAMETER	EXTERNAL DIAMETER	HEIGHT
63.65 mm.	47.63 mm.	7.95 mm.



RE-16313-S		
DIÁMETRO INTERIOR	DIÁMETRO EXTERIOR	ALTURA
INSIDE DIAMETER	EXTERNAL DIAMETER	HEIGHT
42 mm.	53 mm.	7 mm.



RE-17001-N		
DIÁMETRO INTERIOR	DIÁMETRO EXTERIOR	ALTURA
INSIDE DIAMETER	EXTERNAL DIAMETER	HEIGHT
121 mm.	159 mm.	15 mm.

\*\* Para ver aplicación dirigirse a catálogo electrónico: [catalogo.dcp.com.mx](http://catalogo.dcp.com.mx).



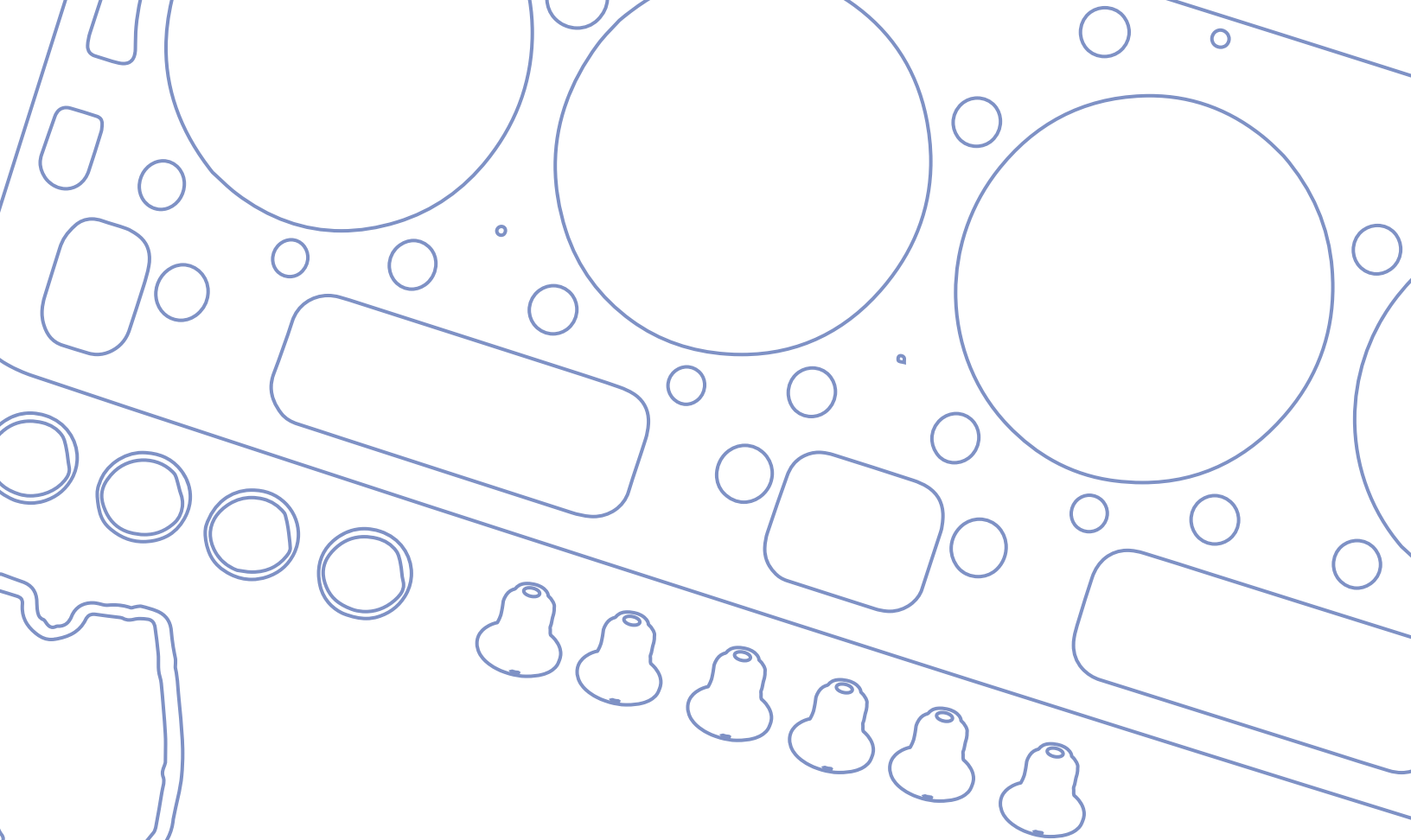

■ ***JUNTAS DE ESCAPE***  
***/EXHAUST GASKETS***

**SECCIÓN**  
**/SECTION**

CATÁLOGO DE APLICACIONES / APPLICATION CATALOG

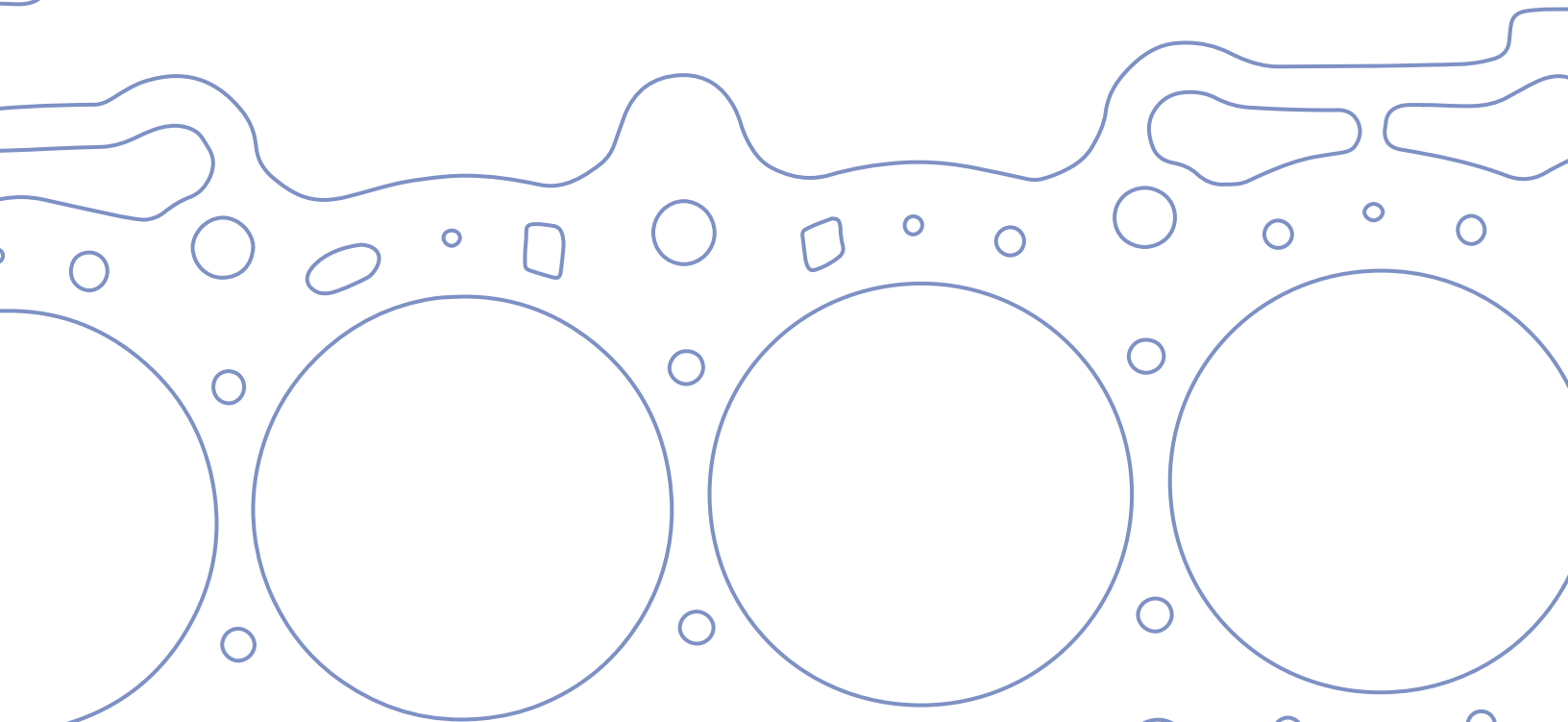





2.5L	MOTOR	MODELOS	DESDE / A	
	ENGINE	MODELS	FROM / TO	
LA-5105	4L OHV 8V 151" VIN 2 R	CELEBRITY, CITATION, CJ5, CJ7.	1979/1983	
2.8L	MOTOR	MODELOS	DESDE / A	
	ENGINE	MODELS	FROM / TO	
LA-5140	V6 OHV 12V GMC-CHEVROLET	S-10 ,S-15, SONOMA, JIMMY.	1982/1996	
2.8L	MOTOR	MODELOS	DESDE / A	
	ENGINE	MODELS	FROM / TO	
LA-5140-CF	V6 OHV 12V GMC-CHEVROLET	S-10 ,S-15, SONOMA, JIMMY.	1982/1996	
3.2L	MOTOR	MODELOS	DESDE / A	
	ENGINE	MODELS	FROM / TO	
LA-5710	L6 OHV 12V 199"	EAGLE, RAMBLER AMERICAN, PACER, AMBASSADOR, JAVELIN.	1965/1983	
3.8L	MOTOR	MODELOS	DESDE / A	
	ENGINE	MODELS	FROM / TO	
LA-5710	L6 OHV 12V 232"	EAGLE, RAMBLER AMERICAN, PACER, AMBASSADOR, JAVELIN.	1965/1983	
4.2L	MOTOR	MODELOS	DESDE / A	
	ENGINE	MODELS	FROM / TO	
LA-5710	L6 OHV 12V 258"	EAGLE, RAMBLER AMERICAN, PACER, AMBASSADOR, JAVELIN.	1965/1983	
4.6L	MOTOR	MODELOS	DESDE / A	
	ENGINE	MODELS	FROM / TO	
LA-5710	L6 OHV 12V 282"	EAGLE, RAMBLER AMERICAN, PACER, WAGONEER, JAVELIN.	1965/1987	



1.0L	MOTOR	MODELOS	DESDE / A
	ENGINE	MODELS	FROM / TO
LB-5201	4L SOHC.12 V G4HC	ATOS.	2000/2003

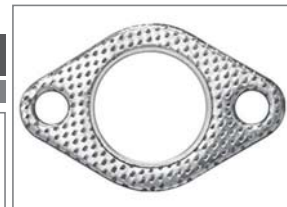

1.4L	MOTOR	MODELOS	DESDE / A
	ENGINE	MODELS	FROM / TO
LB-5230	4L SOHC 8V MOTOR MITSUBISHI G15B	COLT, MIRAGE, EXCEL.	1979/1991



1.5L	MOTOR	MODELOS	DESDE / A
	ENGINE	MODELS	FROM / TO
LB-5230-1	4L SOHC 12V	COLT, MIRAGE, VISTA	1985/1990



1.5L	MOTOR	MODELOS	DESDE / A
	ENGINE	MODELS	FROM / TO
LB-5230	4L SOHC 8V MOTOR MITSUBISHI G15B	COLT, MIRAGE, EXCEL.	1979/1984



2.0L	MOTOR	MODELOS	DESDE / A
	ENGINE	MODELS	FROM / TO
LA-5242	4L DOHC 16V VIN C, Y	NEON, SEBRING.	1995/1999



2.0L	MOTOR	MODELOS	DESDE / A
	ENGINE	MODELS	FROM / TO
LA-5242-M	4L DOHC 16V VIN C, Y	NEON, SEBRING.	1995/1999



2.0L	MOTOR	MODELOS	DESDE / A
	ENGINE	MODELS	FROM / TO
LB-5243	4L SOHC, DOHC.	NEON, STRATUS, CIRRUS	2000/2007



2.2L	MOTOR	MODELOS	DESDE / A
	ENGINE	MODELS	FROM / TO
LA-5240-G	4L SOHC 8V VIN K C D EXCEPTO TURBO	VOYAGER, DART K, SHADOW, SPIRIT, DAYTONA, LeBARON.	1981/1988







2.2L	MOTOR	MODELOS	DESDE / A
	ENGINE	MODELS	FROM / TO
<b>LA-5240-M</b>	4L SOHC 8V VIN K C D EXCEPTO TURBO	VOYAGER, DART K, SHADOW, SPIRIT, DAYTONA, LeBARON.	1981/1988



2.5L	MOTOR	MODELOS	DESDE / A
	ENGINE	MODELS	FROM / TO
<b>LA-5240-G</b>	4L SOHC 8V VIN K C D EXCEPTO TURBO	VOYAGER, DART K, SHADOW, SPIRIT, DAYTONA, LeBARON.	1981/1988



2.5L	MOTOR	MODELOS	DESDE / A
	ENGINE	MODELS	FROM / TO
<b>LA-5240-M</b>	4L SOHC 8V VIN K C D EXCEPTO TURBO	VOYAGER, DART K, SHADOW, SPIRIT, DAYTONA, LeBARON.	1981/1988



2.8L	MOTOR	MODELOS	DESDE / A
	ENGINE	MODELS	FROM / TO
<b>LB-5220</b>	6L OHV 12V (EXC.ALUMINO)	AUTOS Y CAMIONES	1958/1990



3.0L	MOTOR	MODELOS	DESDE / A
	ENGINE	MODELS	FROM / TO
<b>LB-5253</b>	V6 SOHC 12V MOTOR MITSUBISHI 6G72 MULT. ESCAPE S/DEFLECTOR	CARAVAN, VOYAGER, LeBARON, DYNASTY.	1987/1995



3.7L	MOTOR	MODELOS	DESDE / A
	ENGINE	MODELS	FROM / TO
<b>LB-5200-S</b>	6L OHV	DODGE DART,PICKUP D150,D250	1960/1988



3.7L	MOTOR	MODELOS	DESDE / A
	ENGINE	MODELS	FROM / TO
<b>LB-5200</b>	6L OHV	DODGE DART,PICKUP D150,D250	1960/1988



4.1L	MOTOR	MODELOS	DESDE / A
	ENGINE	MODELS	FROM / TO
<b>LB-5200-S</b>	L6 OHV MOTOR "251"	NEWPORT, TOWN & COUNTRY, WINDSOR	1954/1960





4.1L	MOTOR	MODELOS	DESDE / A
	ENGINE	MODELS	FROM / TO
LB-5200-S	L6 OHV MOTOR "251"	NEWPORT, TOWN & COUNTRY, WINDSOR	1954/1960



4.1L	MOTOR	MODELOS	DESDE / A
	ENGINE	MODELS	FROM / TO
LB-5200	L6 OHV MOTOR "251"	NEWPORT, TOWN & COUNTRY, WINDSOR	1954/1960

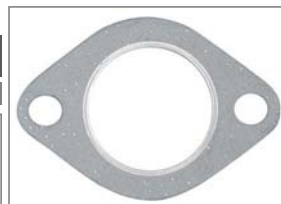

4.5L	MOTOR	MODELOS	DESDE / A
	ENGINE	MODELS	FROM / TO
LB-5260	V8 OHV 16V	VALIANT, DART, CHARGER, BARRACUDA, MONACO, CORONET.	1964/1969



5.2L	MOTOR	MODELOS	DESDE / A
	ENGINE	MODELS	FROM / TO
LB-5260	V8 OHV 16V	VALIANT, DART, CHARGER, BARRACUDA, MONACO, CORONET.	1964/1969



5.7L	MOTOR	MODELOS	DESDE / A
	ENGINE	MODELS	FROM / TO
LB-5273	V8 OHV 16V MOTOR HEMI CABEZA DE GRAFITO	300C, CHALLENGER, CHARGER.	2005/2012;





1.6L	MOTOR	MODELOS	DESDE / A	
	ENGINE	MODELS	FROM / TO	
LA-5317	4L SOHC 8V ZETEC ROCAM	FIESTA, IKON, Ka, COURIER.	2001/2010	
1.9L	MOTOR	MODELOS	DESDE / A	
	ENGINE	MODELS	FROM / TO	
LA-5115-M	4L DOHC 16V 116"VIN 7.	SATURN SC, SC2, SL2, SW2.	1991/1995	
1.9L	MOTOR	MODELOS	DESDE / A	
	ENGINE	MODELS	FROM / TO	
LA-5115-G	4L DOHC 16V 116"VIN 7.	SATURN SC, SC2, SL2, SW2.	1991/1995	
2.0L	MOTOR	MODELOS	DESDE / A	
	ENGINE	MODELS	FROM / TO	
LB-5313	4L DOHC 16V	CONTOUR, ESCORT, FOCUS, ZX2.	1995/1997	
2.3L	MOTOR	MODELOS	DESDE / A	
	ENGINE	MODELS	FROM / TO	
LB-5300	4L OHV 8V VIN R S X	TEMPO, TOPAZ.	1984/1994	
2.3L	MOTOR	MODELOS	DESDE / A	
	ENGINE	MODELS	FROM / TO	
LA-5300	4L OHV 8V VIN R S X	TEMPO, TOPAZ.	1984/1994	
2.4L	MOTOR	MODELOS	DESDE / A	
	ENGINE	MODELS	FROM / TO	
LB-5320	6L OHV	FALCON, MAVERICK, CUSTOM ECONO-LINE.	1960/1983	
2.4L	MOTOR	MODELOS	DESDE / A	
	ENGINE	MODELS	FROM / TO	
LA-5320-A	6L OHV	FALCON, MAVERICK, CUSTOM ECONO-LINE.	1960/1983	



2.8L	MOTOR	MODELOS	DESDE / A
	ENGINE	MODELS	FROM / TO
LB-5320	6L OHV (144,170,200,250)	FALCON, MAVERICK, CUSTOM ECONO-LINE,	1960/1972



2.8L	MOTOR	MODELOS	DESDE / A
	ENGINE	MODELS	FROM / TO
LA-5320-A	6L OHV (144,170,200,250)	FALCON, MAVERICK, CUSTOM ECONO-LINE,	1960/1972



2.9L	MOTOR	MODELOS	DESDE / A
	ENGINE	MODELS	FROM / TO
LA-5308	V6 OHV 12V CARB	RANGER, BRONCO II, SCORPIO	1986/1992



3.5L	MOTOR	MODELOS	DESDE / A
	ENGINE	MODELS	FROM / TO
LB-5310	V6 OHV 12V	CUSTOM, WAGON PICK-UP.	1954-1964



3.8L	MOTOR	MODELOS	DESDE / A
	ENGINE	MODELS	FROM / TO
LB-5330	V6 OHV 12 CARB.	COUGAR, THUNDERBIRD	1984/1987



4.0L	MOTOR	MODELOS	DESDE / A
	ENGINE	MODELS	FROM / TO
LB-5335	V6 OHV 12V VIN X	EXPLORER, RANGER.	1990/1994



5.4L	MOTOR	MODELOS	DESDE / A
	ENGINE	MODELS	FROM / TO
LA-5355	V8 OHV 16V (332-)-352-360-390-410-427-428	AUTOS Y CAMIONES.	1961/1976



5.8L	MOTOR	MODELOS	DESDE / A
	ENGINE	MODELS	FROM / TO
LB-5365	V8 OHV 16V (351W)	TRUCKS, GALAXIE, GRAND MARQUIS.	1969/1983







1.4L	MOTOR	MODELOS	DESDE / A
	ENGINE	MODELS	FROM / TO
LA-5100	4L SOHC 8V	CHEVY POP, JOY, SWING.	1994/2001



1.6L	MOTOR	MODELOS	DESDE / A
	ENGINE	MODELS	FROM / TO
LB-51310-1	4L DOHC 16V VIN "5"	GEO,PRIZM;CHEVROLET NOVA	1988/1992



1.6L	MOTOR	MODELOS	DESDE / A
	ENGINE	MODELS	FROM / TO
LB-51310-2	4L SOHC	TOYOTA GEO PRIZM	1993/1997



1.8L	MOTOR	MODELOS	DESDE / A
	ENGINE	MODELS	FROM / TO
LB-5122	4L DOHC 16V MOTOR ECOTEC LUW	CRUZE (CABEZA DE GRAFITO).	2011/2013



1.8L	MOTOR	MODELOS	DESDE / A
	ENGINE	MODELS	FROM / TO
LB-5118	4L SOHC 8V	CORSA, PICK-UP TORNADO.	2003/2006



3.0L	MOTOR	MODELOS	DESDE / A
	ENGINE	MODELS	FROM / TO
LA-5161	V6 OHV PONTIAC,BUICK	PARK AVENUE, ELECTRA,SKYLARK	1981/1988



3.0L	MOTOR	MODELOS	DESDE / A
	ENGINE	MODELS	FROM / TO
LA-5142-1	V6 OHV 12V VIN 3	BUICK REGAL, LeSABRE, RIVIERA, CAPRICE, EL CAMINO, PONTIAC BONNEVILLE, CUTLASS.	1982/1985



3.1L	MOTOR	MODELOS	DESDE / A
	ENGINE	MODELS	FROM / TO
LA-5145-1	V6 OHV 12V 189"VIN M J	LUMINA SEDAN, MALIBU.	2000/2003





3.1L	MOTOR	MODELOS	DESDE / A
	ENGINE	MODELS	FROM / TO
LA-5145	V6 OHV 12V 189 CID	LUMINA, MONTECARLO, CENTURY.	1993/1996



3.5L	MOTOR	MODELOS	DESDE / A
	ENGINE	MODELS	FROM / TO
LA-5110	6L OHV 12V 216"	BEL AIR, FLEETMASTER, TWO-TEN SERIES, AUTOS Y CAMIONES TODOS.	1937/1953



3.8L	MOTOR	MODELOS	DESDE / A
	ENGINE	MODELS	FROM / TO
LA-5148-G	V6 OHV 12V (231 CID) VIN "K"	CAMARO, FIREBIRD, GRAND PRIX.	1977/2001



3.8L	MOTOR	MODELOS	DESDE / A
	ENGINE	MODELS	FROM / TO
LA-5148-G	V6 OHV 12V 231" VIN K	GRAND PRIX, MONTE CARLO, LUMINA, IMPALA, BONNEVILLE.	1997/2005



3.8L	MOTOR	MODELOS	DESDE / A
	ENGINE	MODELS	FROM / TO
LA-5142	V6 OHV 12V VIN A B C 3 4 6 7 8 9	AUTOS BUICK, CUTLASS, MONTE CARLO, MALIBU.	1977/1982



4.1L	MOTOR	MODELOS	DESDE / A
	ENGINE	MODELS	FROM / TO
LA-5130-G	6L OHV 12V	AUTOS Y CAMIONES CARBURADOS & TBI.	1963/1992



4.2L	MOTOR	MODELOS	DESDE / A
	ENGINE	MODELS	FROM / TO
LA-5153-G	6L DOHC 24V 256" MOTOR VORTEC VIN S	TRAILBLAZER, ENVOY, ASCENDER, BRAVADA (CABEZA DE GRAFITO).	2002/2006



4.3L	MOTOR	MODELOS	DESDE / A
	ENGINE	MODELS	FROM / TO
LA-5144	V6 OHV 12V VIN Z	ASTRO, PICKUP C10, C20, C1500, C2500, SAFARI, CAPRICE, EL CAMINO.	1985/1990





<b>4.3L</b>	<b>MOTOR</b>	<b>MODELOS</b>	<b>DESDE / A</b>	
	<b>ENGINE</b>	<b>MODELS</b>	<b>FROM / TO</b>	
<b>LA-5160-3</b>	V8 OHV VORTEC	CHEYENNE, SUBURBAN, SILVERADO	1996/2009	
<b>4.8L</b>	<b>MOTOR</b>	<b>MODELOS</b>	<b>DESDE / A</b>	
	<b>ENGINE</b>	<b>MODELS</b>	<b>FROM / TO</b>	
<b>LA-5130-G</b>	6L OHV 12V	AUTOS Y CAMIONES CARBURADOS & TBI.	1963/1992	
<b>4.8L</b>	<b>MOTOR</b>	<b>MODELOS</b>	<b>DESDE / A</b>	
	<b>ENGINE</b>	<b>MODELS</b>	<b>FROM / TO</b>	
<b>LA-5160-4</b>	V8 OHV 16V VORTEC	SUBURBAN, AVALANCHE, TRAILBLAZER	1999/2009	
<b>4.8L</b>	<b>MOTOR</b>	<b>MODELOS</b>	<b>DESDE / A</b>	
	<b>ENGINE</b>	<b>MODELS</b>	<b>FROM / TO</b>	
<b>LA-5175</b>	V8 SOHC 16V VORTEC VIN VT	CHEYENNE, SILVERADO 1500, 2500, SUBURBAN, YUKON, SIERRA 1500, 2500, TAHOE (CABEZAS DE GRAFITO).	1999/2001	
<b>5.0L</b>	<b>MOTOR</b>	<b>MODELOS</b>	<b>DESDE / A</b>	
	<b>ENGINE</b>	<b>MODELS</b>	<b>FROM / TO</b>	
<b>LA-5160-1</b>	V8 OHV 16V 305"	CARBURADOS, AUTOS Y CAMIONETAS.	1981/1987	
<b>5.0L</b>	<b>MOTOR</b>	<b>MODELOS</b>	<b>DESDE / A</b>	
	<b>ENGINE</b>	<b>MODELS</b>	<b>FROM / TO</b>	
<b>LA-5160</b>	V8 OHV 16V 305"	AUTOS Y CAMIONES.	1976/1980	

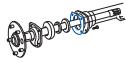

5.0L	MOTOR	MODELOS	DESDE / A
	ENGINE	MODELS	FROM / TO
LA-5160-M	V8 OHV 16V 305"	AUTOS Y CAMIONES.	1976/1980



5.0L	MOTOR	MODELOS	DESDE / A
	ENGINE	MODELS	FROM / TO
LB-5152	V8 OHV 16V (307,337 Y 350 CID)	BLAZER, C10,C10 SUBURBAN	1960-1984



5.3L	MOTOR	MODELOS	DESDE / A
	ENGINE	MODELS	FROM / TO
LA-5175	V8 SOHC 16V VORTEC VIN V T	CHEYENNE, SILVERADO 1500, 2500, SUBURBAN, YUKON, SIERRA 1500, 2500, TAHOE (CABEZAS DE GRAFITO).	1999/2001



5.3L	MOTOR	MODELOS	DESDE / A
	ENGINE	MODELS	FROM / TO
LB-5175	V8 SOHC 16V VORTEC VIN V T	CHEYENNE, SILVERADO 1500, 2500, SUBURBAN, YUKON, SIERRA 1500, 2500, TAHOE (CABEZAS DE GRAFITO).	1999/2001



5.7L	MOTOR	MODELOS	DESDE / A
	ENGINE	MODELS	FROM / TO
LB-5152-1	V8 OHV (307, 348 CID)CHEVROLET	IMPALA, MALIBU, P20 ,P30	1962/1985



5.7L	MOTOR	MODELOS	DESDE / A
	ENGINE	MODELS	FROM / TO
LB-5150	V8 OHV 16V VORTEC MEXICO TBI	MICROBUS, SUBURBAN, C-2500, C-3500, PICK-UP SOLO MEXICO.	1992/1998





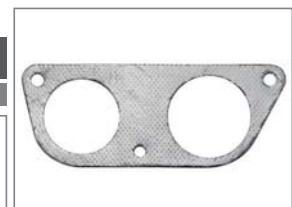

6.0L	MOTOR	MODELOS	DESDE / A
	ENGINE	MODELS	FROM / TO
LB-5176	V8 SOHC 16V VORTEC VIN U	SILVERADO 2500, SIERRA 2500, YUKON, EXPRESS VAN,CARGO VAN, SUBURBAN (CABEZA DE GRAFITO).	1999/2000







1.3L	MOTOR ENGINE	MODELOS MODELS	DESDE / A FROM / TO	
LA-51450	4L SOHC 8V D13A1 D13A2 EV1 EV2	CIVIC.	1984/1987	
1.5L	MOTOR ENGINE	MODELOS MODELS	DESDE / A FROM / TO	
LA-51450	4L SOHC 12V D15A3 EW3 EW4	CIVIC.	1984/1991	
1.6L	MOTOR ENGINE	MODELOS MODELS	DESDE / A FROM / TO	
LA-51490	4L SOHC D16YZ,D17A7.	CIVIC	1996/2004	
2.2L	MOTOR ENGINE	MODELOS MODELS	DESDE / A FROM / TO	
LA-51457	4L SOHC 16V F22A4, F22A6, F22A1.	ACCORD, PRELUDE.	1990/1997	

ISUZU ■

2.0L	MOTOR ENGINE	MODELOS MODELS	DESDE / A FROM / TO	
LA-51110	4L SOHC 8V MOTOR "FE" y "F8"	PICK UP B2000, 626.	1983/1987	



1.6L	MOTOR	MODELOS	DESDE / A
	ENGINE	MODELS	FROM / TO
<b>LA-51112</b>	4L SOHC MAZDA ENGINE	MAZDA 626 ;FORD PROBE (2.2L 89-92)	1995/1998



2.0L	MOTOR	MODELOS	DESDE / A
	ENGINE	MODELS	FROM / TO
<b>LB-51110</b>	4L SOHC 8V MOTOR "FE" y "F8"	PICK UP B2000, 626.	1983/1987





1.5L	MOTOR ENGINE	MODELOS MODELS	DESDE / A FROM / TO	
LB-51216	4L SOHC 8V E15	TSURU I.	1983/1987	
1.6L	MOTOR ENGINE	MODELOS MODELS	DESDE / A FROM / TO	
LB-51216	4L DOHC 16V GA16DE MOTOR JAPONES	TSURU III, TSUBAME, 200SX, SENTRA, LUCINO.	1991/1996	
1.6L	MOTOR ENGINE	MODELOS MODELS	DESDE / A FROM / TO	
LB-51226	4L DOHC 16V GA16DE MOTOR JAPONES	TSURU III, TSUBAME, 200SX, SENTRA, LUCINO.	1991/1996	
1.6L	MOTOR ENGINE	MODELOS MODELS	DESDE / A FROM / TO	
LB-51226-1	4L DOHC 16V GA16DE GA16DNE	TSURU III GSI, GSII, SENTRA MEXICO, TSUBAME.	1997/2014	
1.6L	MOTOR ENGINE	MODELOS MODELS	DESDE / A FROM / TO	
LB-51216	4L SOHC 8V E16	TSURU II.	1984/1992	
1.8L	MOTOR ENGINE	MODELOS MODELS	DESDE / A FROM / TO	
LA-51400	4L DATSUN "J" 1500,1600,1700	DATSUN TODOS	1960/1990	
1.8L	MOTOR ENGINE	MODELOS MODELS	DESDE / A FROM / TO	
LB-51218-1	4L SOHC DATSUN	DATSUN 310,510,610,620	1974/1987	
2.0L	MOTOR ENGINE	MODELOS MODELS	DESDE / A FROM / TO	
LB-51222	4L SOHC 8V Z20E	200SX, PICK UP 510.	1980/1981	



2.0L	MOTOR	MODELOS	DESDE / A
	ENGINE	MODELS	FROM / TO
<b>LB-51218</b>	4L SOHC 8 VALV MOTOR L20B	200SX, PICK UP 720, 710, 620, 510.	1977/1980

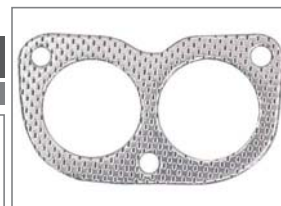

2.4L	MOTOR	MODELOS	DESDE / A
	ENGINE	MODELS	FROM / TO
<b>LB-51225</b>	4L SOHC 12V KA24E KA24S	ICHI VAN, PICK-UP D21, ESTAQUITAS.	1990/1998



3.0L	MOTOR	MODELOS	DESDE / A
	ENGINE	MODELS	FROM / TO
<b>LA-51244</b>	V6 OHV NISSAN	MAXIMA, INFINITY I30.	1996/1999



■ RENAULT

1.6L	MOTOR	MODELOS	DESDE / A
	ENGINE	MODELS	FROM / TO
<b>LB-51530</b>	4L OHV	R12, R18, TS.	1975/1984







2.2L	MOTOR	MODELOS	DESDE / A
	ENGINE	MODELS	FROM / TO
<b>LB-51310</b>	4L SOHC 8V 20R	CELICA, CORONA, PICK-UP.	1975/1980



3.3L	MOTOR	MODELOS	DESDE / A
	ENGINE	MODELS	FROM / TO
<b>LA-51326</b>	V6 DOHC 3MZFE	HIGHLANDER SUV	2004/2007



3.4L	MOTOR	MODELOS	DESDE / A
	ENGINE	MODELS	FROM / TO
<b>LA-51357</b>	V6 DOHC 24V 5VZFE.	TACOMA, 4RUNNER, T-100, TUNDRA.	1995/2004





1.2L	MOTOR	MODELOS	DESDE / A
	ENGINE	MODELS	FROM / TO
LB-51810	H4 8V BOXER	SEDAN.	1963/1965

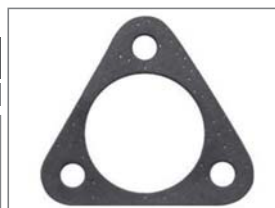

1.2L	MOTOR	MODELOS	DESDE / A
	ENGINE	MODELS	FROM / TO
LB-41810-1	H4 8V BOXER	SEDAN, COMBI	1961/1965



1.7L	MOTOR	MODELOS	DESDE / A
	ENGINE	MODELS	FROM / TO
LB-51830	4L SOHV 8V	CARIBE, ATLANTIC, GOLF	1977/1990

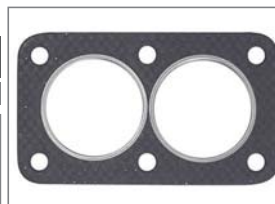

1.8L	MOTOR	MODELOS	DESDE / A
	ENGINE	MODELS	FROM / TO
LB-51840-1	4L SOHC 8V AVH AZG	POINTER, POINTER PICK UP	1998/2002



1.8L	MOTOR	MODELOS	DESDE / A
	ENGINE	MODELS	FROM / TO
LB-51840-2	4L SOHV 8V	POINTER, Y POINTER PICK UP	1998/2004



1.8L	MOTOR	MODELOS	DESDE / A
	ENGINE	MODELS	FROM / TO
LB-41812	H4 OHV 1200,1500,1600,1800	VW SEDAN ,BRASILIA	1968/2000







1.8L	MOTOR	MODELOS	DESDE / A
	ENGINE	MODELS	FROM / TO
LA-51800	H4 OHV 1200,1500,1600,1800	VW SEDAN ,BRASILIA	1965/2000

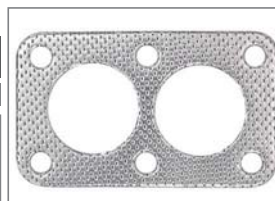

1.8L	MOTOR	MODELOS	DESDE / A
	ENGINE	MODELS	FROM / TO
LB-51840	4L SOHC 8V CARB & FI	JETTA A2, GOLF, CORSAR, CABRIOLET, RABBIT.	1983/1998



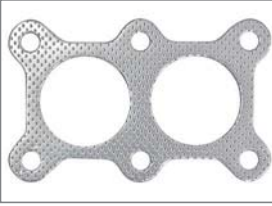

<b>1.8L</b>	<b>MOTOR</b>	<b>MODELOS</b>	<b>DESDE / A</b>	
<b>LB-41811</b>	<b>ENGINE</b>	<b>MODELS</b>	<b>FROM / TO</b>	
	H4 OHV 1200,1500,1600,1800	VW SEDAN ,BRASILIA	1968/2000	
<b>1.8L</b>	<b>MOTOR</b>	<b>MODELOS</b>	<b>DESDE / A</b>	
<b>LB-51852</b>	<b>ENGINE</b>	<b>MODELS</b>	<b>FROM / TO</b>	
	4L DOHC 20V (ADR,AFY,ANB)	PASSAT,BEETLE	1999/2005	
<b>1.8L</b>	<b>MOTOR</b>	<b>MODELOS</b>	<b>DESDE / A</b>	
<b>LA-51840</b>	<b>ENGINE</b>	<b>MODELS</b>	<b>FROM / TO</b>	
	4L SOHC 8V CARB & FI	JETTA A2, GOLF, CORSAR, CABRIOLET, RABBIT.	1983/1998	
<b>2.0L</b>	<b>MOTOR</b>	<b>MODELOS</b>	<b>DESDE / A</b>	
<b>LB-51845</b>	<b>ENGINE</b>	<b>MODELS</b>	<b>FROM / TO</b>	
	4L SOHC 8V ABA	JETTA A3, GOLF, CABRIO.	1993/1999	
<b>2.5L</b>	<b>MOTOR</b>	<b>MODELOS</b>	<b>DESDE / A</b>	
<b>LB-51856</b>	<b>ENGINE</b>	<b>MODELS</b>	<b>FROM / TO</b>	
	5L DOHC 20V	BORA,BEETLE	2005/2010	



NOTAS / NOTES:

Lined area for notes, consisting of multiple horizontal lines for writing.



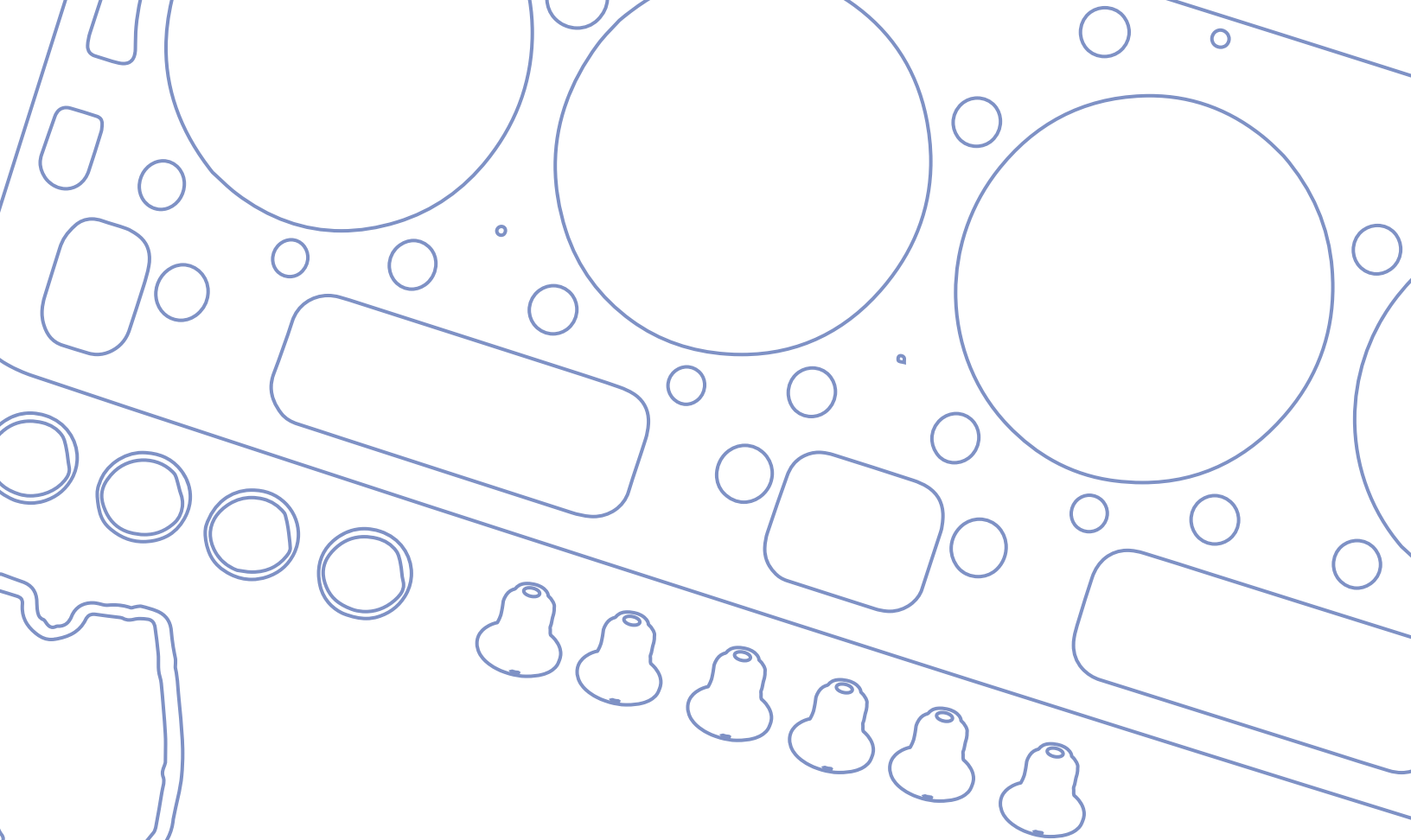

# **NEW INTEGRATIONS**

## **NUEVAS INTEGRACIONES**

**SECCIÓN/  
SECTION**

CATÁLOGO DE APLICACIONES / APPLICATION CATALOG

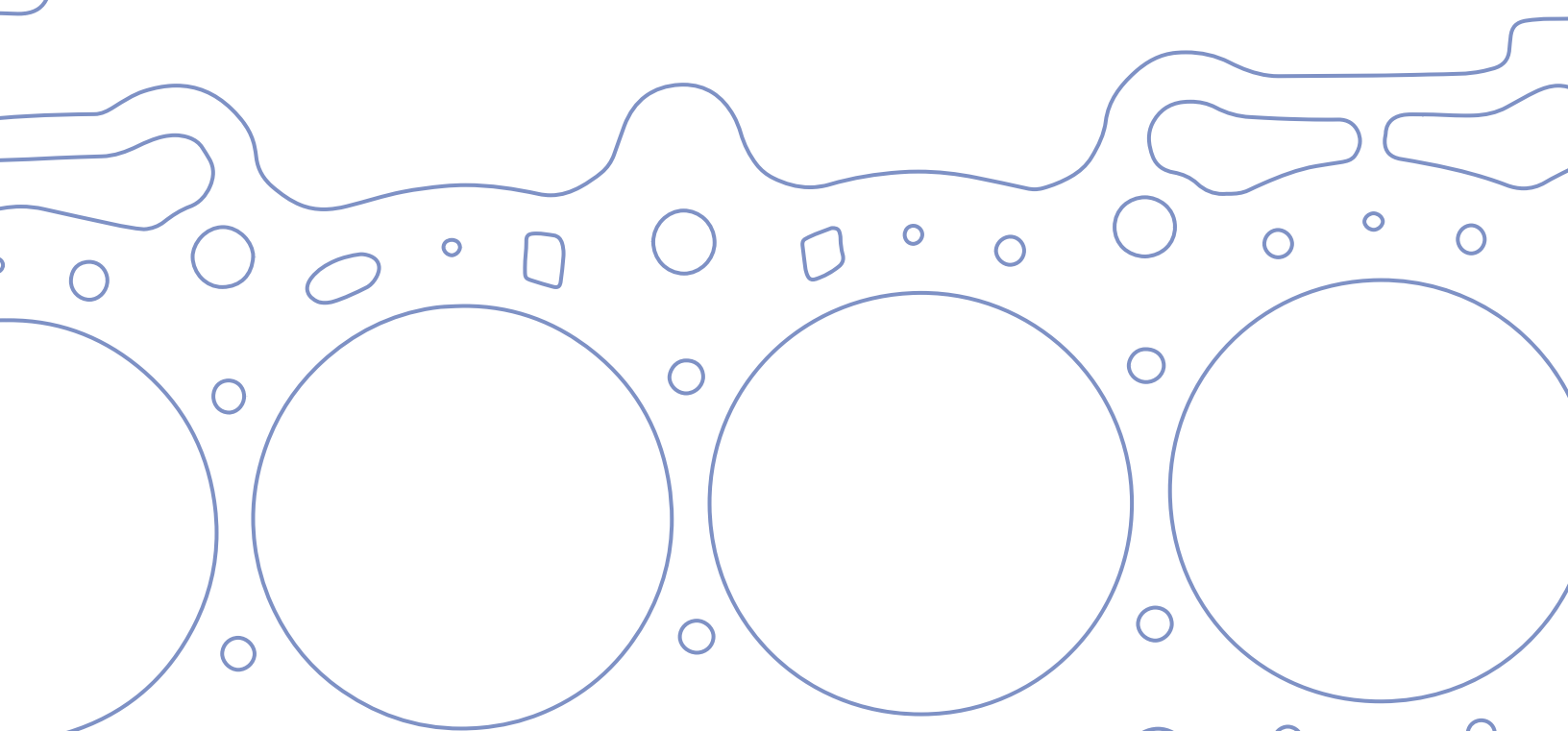



**NEW INTEGRATIONS**

# PARTE	MARCA	MODELO	AÑO	PÁGINA
# PART	MAKE	MODEL	YEAR	PAGE
FS-269-ML	CHRYSLER/DODGE	Avenger, Grand Caravan, Journey, Town & Country	2011/2014	330
FS-111-G	GMC/SATURN	SL, SL1, SC1, SW1	1991/1999	330
FS-113-G	GMC/PONTIAC	MALIBU,SUNFIRE ,GRAND AM	2002/2005	330
FS-126-ML	GMC/CHEVROLET	VIN "8", COLORADO, CANYON	2004/2006	330
FS-127-ML	GMC/CHEVROLET	VIN:"9" COLORADO, CANYON, I-290	2007/2012	330
FS-128-ML	GMC/CHEVROLET	VIN:"6" COLORADO, CANYON, H3, i-350	2004/2006	330
FS-145-2	GM/CHEVROLET	VIN "M", CENTURY, LUMINA, MALIBU	1995/1999	331
FS-153-ML	GM/CHEVROLET	VIN "S" TRAILBLAZER, ENVOY, ASCENDER, BRAVADA	2002/2006	331
FS-174-G	GM/CADILLAC	VIN: Y,9 ELDORADO,SEVILLE,DEVILLE	2000/2001	331
FS-1235-ML	NISSAN	ALTIMA, SENTRA, X-TRAIL	2000/2006	331
FS-1550-G	NISSAN/RENAULT	NISSAN PLATINA, RENAULT CLIO, KANGOO	2002/2010	331
CA-226-1ML	CHRYSLER/DODGE	GEMA ECN: VIN: A, CALIBER, COMPASS, PATRIOT	2007/2013	332
CA-226-GX	CHRYSLER/DODGE	GEMA ECN: VIN: W, CALIBER, COMPASS, PATRIOT	2007/2013	332
CA-126-ML	GMC/CHEVROLET	VIN "8" COLORADO, CANYON	2004/2006	332
CA-127-ML	GMC/CHEVROLET	VIN:"9", COLORADO, CANYON, I-290	2007/2012	332
CA-321-1ML	FORD/PEUGEOT/FIAT	TRANSIT, DUCATO, BOXER	2008/2012	332
CA-356-GX	FORD/LINCOLN	""TRITON"" LINCOLN, GRAND MARQUIS"	1991/2007	332
CA-357-GX	FORD/LINCOLN	""TRITON"" LINCOLN, GRAND MARQUIS"	1991/2007	332
CA-715-ML	JEEP	VIN "L","M","S","V" CHEROKEE, WRANGLER	1987/2006	332
CA-1245-GX	NISSAN	ALTIMA, SENTRA, URVAN,ROGUE	2007/2009	332
CA-96-ML	SUZUKI	SWIFT, IGNIS	2007/2009	332
CA-133-1ML	SUZUKI	SUZUKI AERIO	2004/2007	333
CA-1301-G	TOYOTA	CALOINA, COROLLA	1971/1982	333
CA-1316-ML	TOYOTA	YARIS, COROLLA, VITZ, PLATZ, AURIS	2007/2013	333
CA-1365-ML	TOYOTA	4RUNNER	2004/2006	333
CA-1365-1ML	TOYOTA	4RUNNER	2004/2006	333
CA-1369-1ML	TOYOTA	TUNDRA, LX570, LAND CRUISER, SEQUOIA	2004/2006	333
CA-1369-ML	TOYOTA	TUNDRA, LX570, LAND CRUISER, SEQUOIA	2007/2013	333
CA-1837-ML	VW	VENTO, POLO	2007/2013	333
BS-7133-V	GMC/SUZUKI	TRACKER, SX4, VITARA	1999/2009	334
BS-7126-T	GMC/CHEVROLET	COLORADO, CANYON, H3, I-280, I-290, I-350, I-370	2004/2012	334
ES-91128-NS	FORD/MAZDA/MERCURY	VIN Z ,D ,N, JUNTA ENFRIADOR DE ACEITE; MAZDA 3, MAZDA 5, CX7, ESCAPE, TRANSIT, FOCUS	2005/2013	334
LA-51235	NISSAN	XTRAIL Y SENTRA	2007/2013	334
LB-5273	CHRYSLER/DODGE/JEEP	DURANGO ,GRAND CHEROKEE	2004/2008	334
LB-51856	VOLKSWAGEN	BORA, BEETLE MODELOS A5	2005/2010	334
MS-4269	CHRYSLER/DODGE	Avenger, Grand Caravan, Journey, Town & Country, Routan,Wrangler,Grand Cherokee, Durango.	2011/2014	334
MS-4275-3	CHRYSLER/DODGE	DURANGO, RAM 1500, GRAND CHEROKEE	1998/2003	334
MS-41108-E	FORD / MAZDA	323, TRACER	1986/1989	334
MS-4303-3NS	FORD	FOCUS LX/SE	2000/2004	334
MS-4318-1E	FORD/MAZDA/MERCURY	RANGER, AEROSTAR, TAURUS, WINDSTAR, SABLE	1996/2008	334
MS-4335-2P	FORD/MAZDA	VIN X EXPLORER, RANGER, B4000	1998/2001	334
MS-4126-E	GM/CHEVROLET	VIN "8" COLORADO	2004/2006	334
MS-4126	GM/CHEVROLET	COLORADO, CANYON, I-290, I-280	2004/2012	334



**NEW INTEGRACIONES**

# PARTE	MARCA	MODELO	AÑO	PÁGINA
# PART	MAKE	MODEL	YEAR	PAGE
MS-4127-E	GM/CHEVROLET	VIN: 9 ; COLORADO, CANYON, I-290	2007/2012	<b>334</b>
MS-4128	GM/CHEVROLET	COLORADO, CANYON , H3, i-350, i-370	2004/2012	<b>335</b>
MS-4129-E	GM/CHEVROLET	VIN E COLORADO,CANYON, H3,H3T, i-370	2007/2012	<b>335</b>
MS-4175-1A	GM/CHEVROLET	YUKON,SIERRA,SAVANA,TAHOE,SSR	1999/2003	<b>335</b>
MS-4175-2NS	GM/CHEVROLET	SILVERADO 1500, TAHOE, TRAILBLAZER, ENVOY, SIERRA, YUKON.	2007/2011	<b>335</b>
MS-4175-A	GM/CHEVROLET	CAMARO, CORVETTE, CTS	1998/2004	<b>335</b>
MS-4176-1LS	GM/CHEVROLET	CTS, ESCALADE, EXPRESS, CAMARO, COLORADO, CORVETTE, CANYON,SILVERADO, SIERRA, YUKON.	2007/2011	<b>335</b>
MS-41457-3	HONDA / ACURA	ACCORD, ODYSSEY, ACURA CL	1994/1997	<b>335</b>
MS-41457-1	HONDA	ACCORD, PRELUDE	1990/1996	<b>335</b>
MS-4247-E	MITSUBISHI	VIN "F" GALANT, LANCER, ECLIPSE	2005/2009	<b>335</b>
MS-4247-A	MITSUBISHI	VIN "F" GALANT, LANCER, ECLIPSE	2005/2009	<b>335</b>
MS-41244-A	NISSAN/INFINITY	MAXIMA, INFINITY I30	1995/2000	<b>335</b>
MS-41229-1P	NISSAN / MERCURY	NISSAN QUEST , MERCURY VILLAGER	1993/1998	<b>335</b>
MS-41229-A	NISSAN / MERCURY	NISSAN QUEST , MERCURY VILLAGER	1999/2002	<b>335</b>
MS-496-E	SUZUKI	SWIFT, IGNIS	2007/2009	<b>335</b>
MS-496-R	SUZUKI	SWIFT, IGNIS	2007/2009	<b>335</b>
MS-41354	TOYOTA	4 RUNNER, TACOMA	2005/2013	<b>336</b>
MS-41316	TOYOTA	YARIS, COROLLA, VITZ, PLATZ, AURIS	2007/2013	<b>336</b>
MS-41856-E	VOLKSWAGEN	BORA, BEETLE MODELOS A5	2005/2010	<b>336</b>
OS-1251-1	CHRYSLER/MITSUBISHI	VIN "G" SEBRING, STRATUS, LANCER	2001/2005	<b>336</b>
RE-16317-V	FORD	FIESTA, KA, IKON, COURIER.	2001/2010	<b>336</b>
RE-16122-S	TOYOTA	CAMRY, CELICA, RAV4	1989/1999	<b>336</b>
RE-16058	NISSAN	TSURU GSI GS2 TSUBAME	1994/2010	<b>336</b>
SS-8273-1V	CHRYSLER/DODGE / JEEP	300C, CAMIONES DODGE RAM, JEEP G. CHEROKEE	2009/2016	<b>336</b>
SS-8357-3V	FORD/LINCOLN/MERCURY	MUSTANG, NAVIGATOR, AVIATOR, MARK VIII	1996/2004	<b>336</b>
SS-81353-S	TOYOTA	TOYOTA CAMRY	1987/1992	<b>336</b>
SV-81236-V	NISSAN	ALTIMA, MAXIMA, URBAN X-TRAIL, MURANO, XTERRA	2001/2013	<b>336</b>
SV-81459-V	HONDA/ACURA	CIVIC EX, ACURA EL	2001/2005	<b>336</b>
TC-6133	GMC/SUZUKI	TRACKER, SX4, VITARA	1999/2009	<b>336</b>
TC-61467	HONDA /ACURA/STERLING	ACURA LEGEND, HONDA ACCORD	1986/1991	<b>336</b>
VS-396-R	SUZUKI	SWIFT, IGNIS	2007/2009	<b>336</b>
VS-3242-R	CHRYSLER/DODGE	Vin "Y" Sebring, Neon, Talon	1995/1999	<b>337</b>
VS-3269-R	CHRYSLER/DODGE	Avenger, Grand Caravan, Journey, Town & Country, Routan,Wrangler,Grand Cherokee, Durango.	2011/2014	<b>337</b>
VS-3330-R	FORD	LTD, MUSTANG, THUNDERBIRD, COUGAR, MARQUIS	1986/1987	<b>337</b>
VS-3127-R	GMC/CHEVROLET	VIN: "9", COLORADO, CANYON, I-290	2007/2012	<b>337</b>
VS-3129-R	GMC/CHEVROLET	VIN: "E", COLORADO, CANYON, I-370	2007/2008	<b>337</b>
VS-3153-1R	GMC/CHEVROLET	TRAILBLAZER, ENVOY, RAINIER	2004/2006	<b>337</b>
VS-3154-R	GM/CHEVROLET	COLORADO, CANYON, H3	2004/2006	<b>337</b>
VS-3167-2S	GM/CHEVROLET	C1500,C2500,C3500,R2500,R3500,	1985/1990	<b>337</b>
VS-31750-1R	HONDA / ACURA	VIN W,SLX PASSPORT, RODEO, TROOPER	1992/1995	<b>337</b>
VS-31461-R	HONDA / ACURA	CR-V, ACURA, INTEGRA	1990/2001	<b>337</b>
VS-31242-R	NISSAN	MARCH	2012/2014	<b>337</b>

\* Escanear código QR para consultar en catálogo electrónico o dirígase a [catalogo.dcp.com.mx](http://catalogo.dcp.com.mx).





NEW INTEGRATIONS

# PARTE	MARCA	MODELO	AÑO	PÁGINA
# PART	MAKE	MODEL	YEAR	PAGE
VS-31245-R	NISSAN	ALTIMA, SENTRA	2007/2012	337
VS-3402-1R	SUZUKI /GEO/CHEVROLET	VIN "6" TRACKER, METRO	1994/2002	337
VS-31369-R	TOYOTA/LEXUS	TUNDRA, LX570, LAND CRUISER, SEQUOIA	2007/2013	337
VS-31354-R	TOYOTA	4 RUNNER, TACOMA	2005/2013	337



**FS-269-ML**

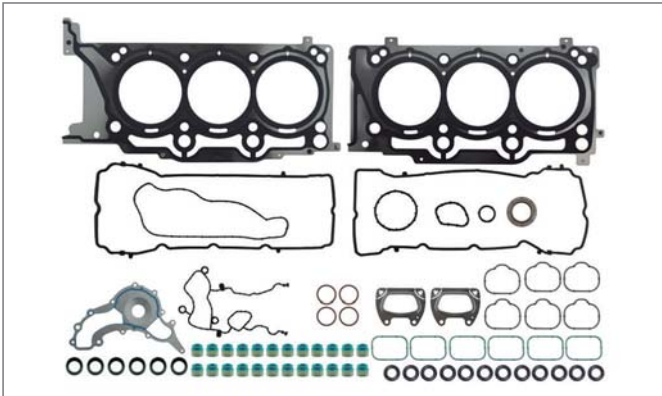

APLICACIÓN

CHRYSLER/DODGE, V6 3.6L DOHC 24V

APLICACION

**FS-111-G**

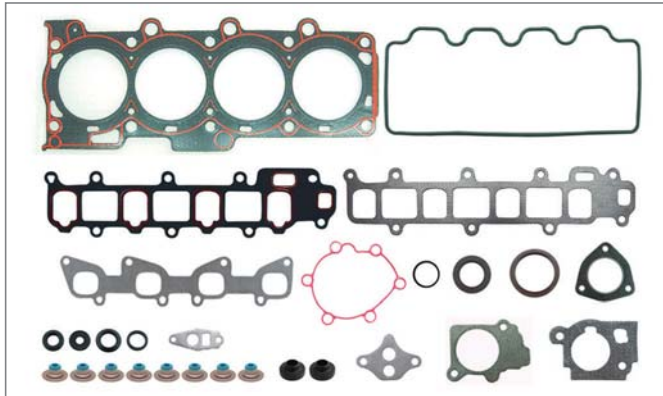

APLICACIÓN

GMC/SATURN, 4L 1.9L 116" 8V SOHC

APLICACION

**FS-113-G**

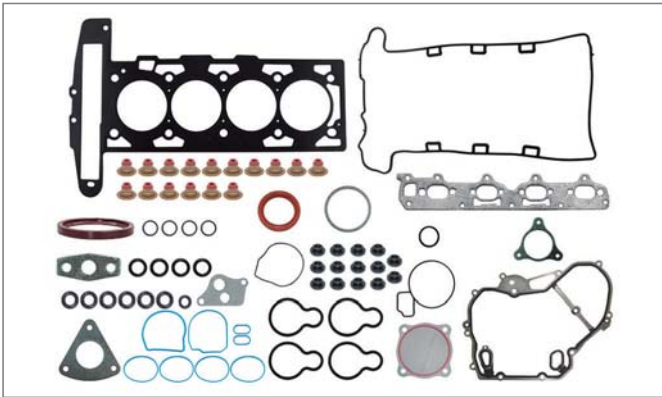

APLICACIÓN

GMC/PONTIAC, 4L 2.2L DOHC 16V ECOTEC

APLICACION

**FS-126-ML**

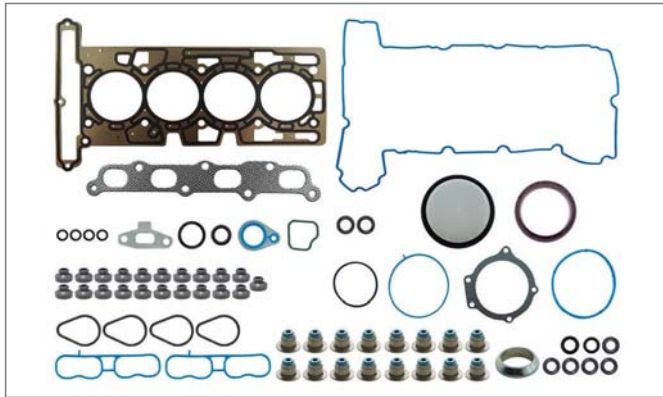

APLICACIÓN

GMC/CHEVROLET, 4L 2.8L 169" DOHC 16V ; LK5

APLICACION

**FS-127-ML**

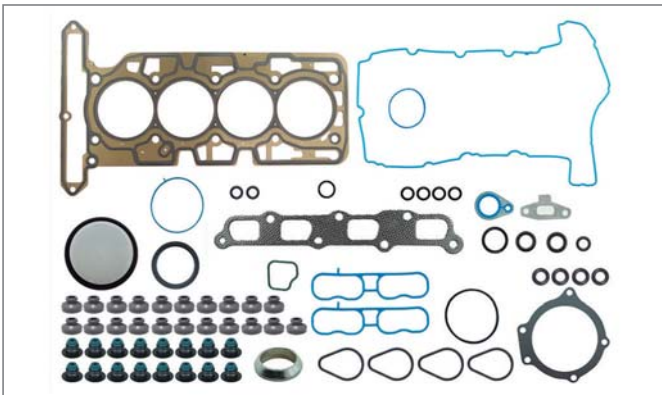

APLICACIÓN

GMC/CHEVROLET, 4L 2.9L, 178" DOHC 16V

APLICACION

**FS-128-ML**

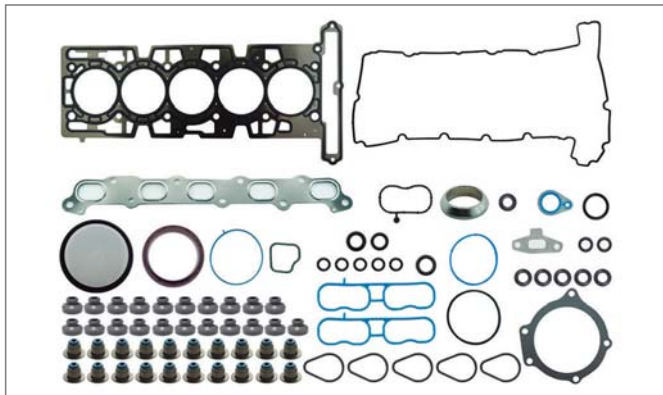

APLICACIÓN

GMC/CHEVROLET, L5 3.5 L DOHC 20V

APLICACION



**FS-145-2**

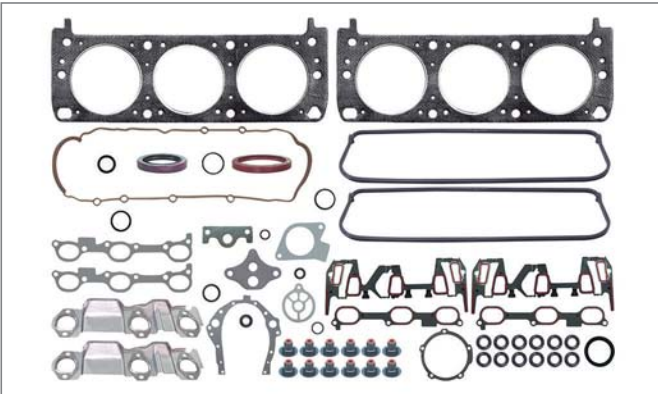

APLICACIÓN

GM/CHEVROLET, V6 3.1L 189" OHV 12V

APPLICATION

**FS-153-ML**

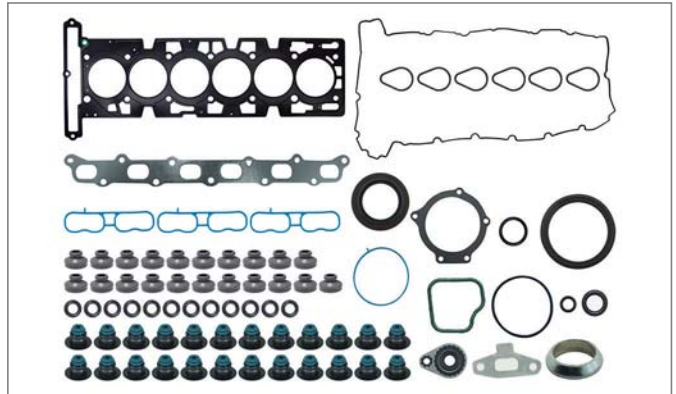

APLICACIÓN

GM/CHEVROLET, L6 4.2L 256" DOHC 24V

APPLICATION

**FS-174-G**

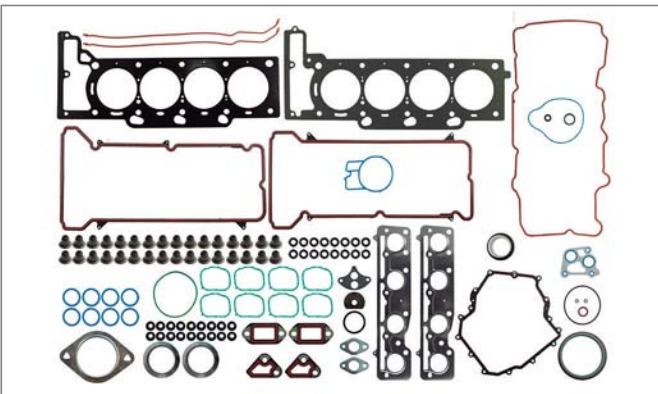

APLICACIÓN

GM/CADILLAC, V8 4.6L 281" DOHC 32V

APPLICATION

**FS-1235-ML**

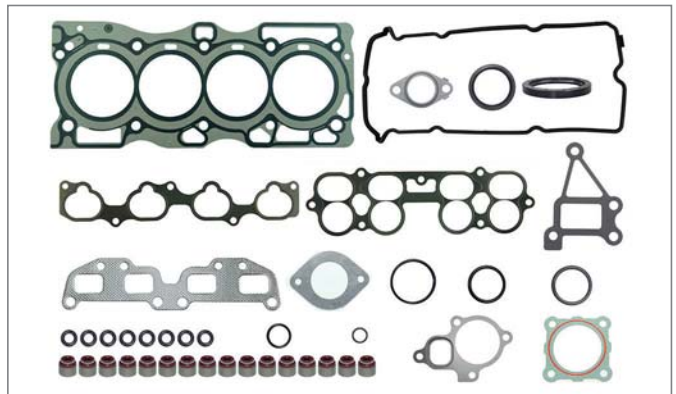

APLICACIÓN

NISSAN, L4 2.5L DOHC 16V; QR25DE

APPLICATION

**FS-1550-G**

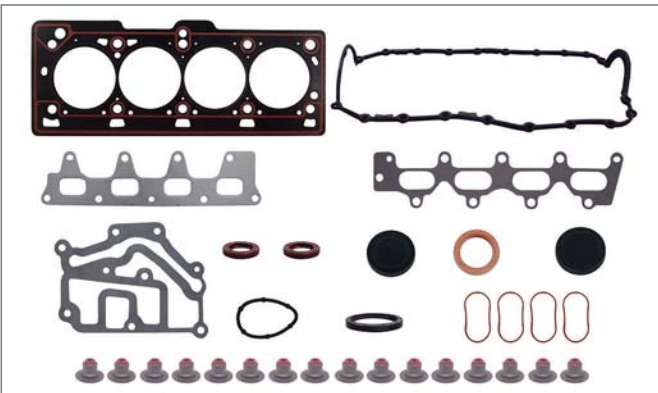

APLICACIÓN

NISSAN/RENAULT, L4 1.6L DOHC 16V; K4M

APPLICATION





CA-226-1ML

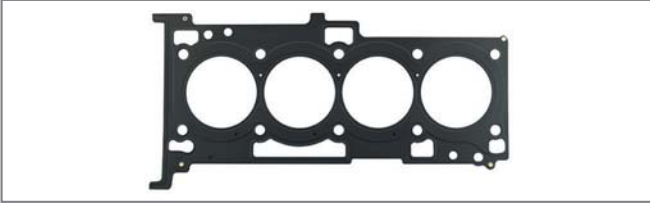

APLICACIÓN  
 APLICACION CHRYSLER/DODGE, 4L 1.8L/2.0L , 110"/122"  
 DOHC 16 V

CA-226-GX



APLICACIÓN  
 APLICACION CHRYSLER/DODGE, 4L 2.4L 144" DOHC 16V

CA-126-ML

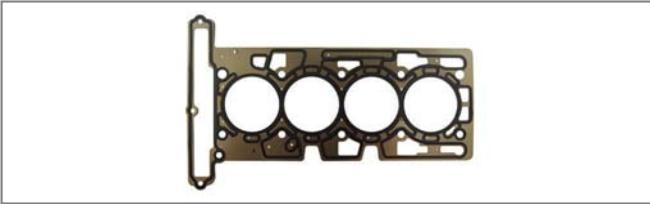

APLICACIÓN  
 APLICACION GMC/CHEVROLET, 4L 2.8L 169" DOHC 16V; LKS

CA-127-ML

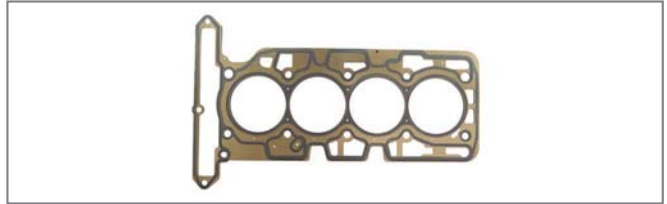

APLICACIÓN  
 APLICACION GMC/CHEVROLET, 4L 2.9L 178" DOHC 16V

CA-321-1ML

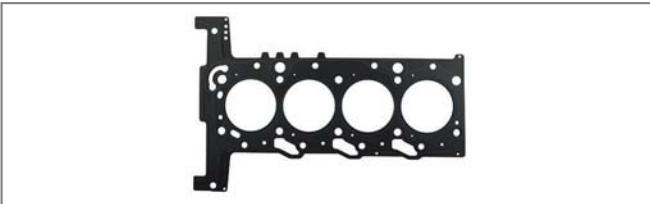

APLICACIÓN  
 APLICACION FORD/PEUGEOT/FIAT, 4L 2.2L DOHC 16V TDCI  
 DIESEL,ZSD PUMA

CA-356-GX

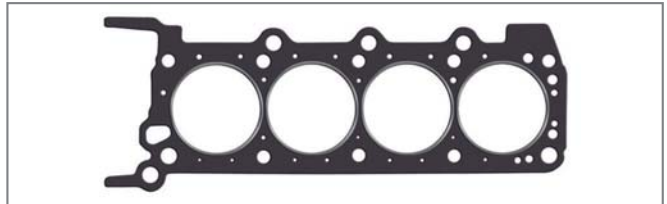

APLICACIÓN  
 APLICACION FORD/LINCOLN, V8 4.6L/5.4L SOHC 16/24V

CA-357-GX

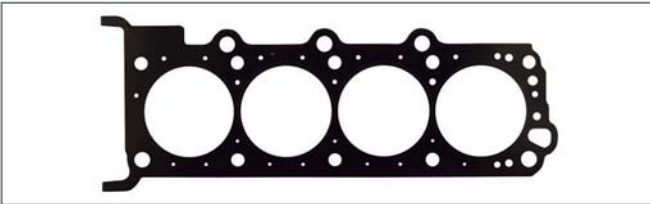

APLICACIÓN  
 APLICACION FORD/LINCOLN, V8 4.6L/5.4L SOHC 16/24V

CA-715-ML

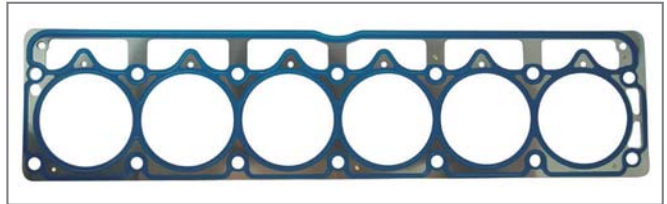

APLICACIÓN  
 APLICACION JEEP, L6 4.0L 242"12V OHV

CA-1245-GX



APLICACIÓN  
 APLICACION NISSAN, 4L 2.5L DOHC 16V; QR25DE

CA-96-ML



APLICACIÓN  
 APLICACION SUZUKI , 4L 1.5L 91" DOHC 16V; M15A





**CA-133-1ML**



APLICACIÓN

SUZUKI, 4L 2.3L 140" DOHC 16V; J23A

APLICACION

**CA-1301-G**



APLICACIÓN

TOYOTA, 4L 1.6L/1.8L OHV 8V

APLICACION

**CA-1316-ML**



APLICACIÓN

TOYOTA, 4L 1.5 L DOHC 16V; 1NZFE

APLICACION

**CA-1365-ML**



APLICACIÓN

TOYOTA, V6 4.0L 241" DOHC 24V; 1GRFE

APLICACION

**CA-1365-1ML**



APLICACIÓN

TOYOTA, V6 4.0L 241" DOHC 24V; 1GRFE

APLICACION

**CA-1369-1ML**

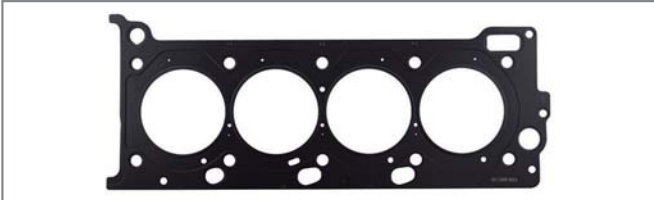

APLICACIÓN

TOYOTA, V8 5.7L DOHC 32V; 1URFSE, IZQUIERDA.

APLICACION

**CA-1369-ML**

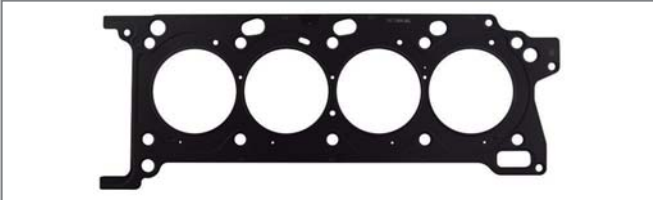

APLICACIÓN

TOYOTA, V8 5.7L DOHC 32v ; 1URFSE, DERECHA.

APLICACION

**CA-1837-ML**

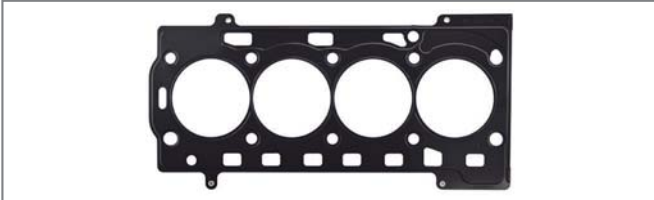

APLICACIÓN

VW, 4L 1.6L DOHC 16V; MPI

APLICACION



**BS-7133-V**



<b>APLICACIÓN</b>	GMC/SUZUKI, 4L 2.0L DOHC 16V
<b>APLICACION</b>	

**BS-7126-T**



<b>APLICACIÓN</b>	GMC/CHEVROLET, 4L/5L DOHC 2.8L/2.9L/3.5L/3.7L
<b>APLICACION</b>	

**ES-91128-NS**



<b>APLICACIÓN</b>	FORD/MAZDA/MERCURY, 4L DOHC 2.0L/2.3L/2.5L
<b>APLICACION</b>	

**LA-51235**



<b>APLICACIÓN</b>	NISSAN, 4L 2.5L DOHC 16V
<b>APLICACION</b>	

**LB-5273**



<b>APLICACIÓN</b>	CHRYSLER/DODGE/JEEP, V8 5.7L HEMI OHV
<b>APLICACION</b>	

**LB-51856**



<b>APLICACIÓN</b>	VOLKSWAGEN, 5L 2.5L 151" DOHC 20V; CBTA, CBUA, BGP
<b>APLICACION</b>	

**MS-4269**

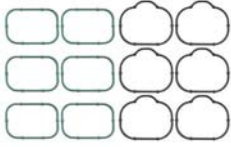

<b>APLICACIÓN</b>	CHRYSLER/DODGE, V6 3.6L 220" DOHC 24V
<b>APLICACION</b>	

**MS-4275-3**

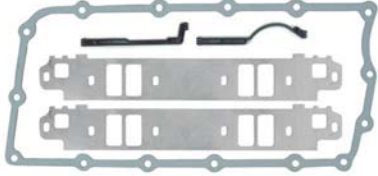

<b>APLICACIÓN</b>	CHRYSLER/DODGE, V8 5.2L/5.9L OHV 16V
<b>APLICACION</b>	

**MS-41108-E**



<b>APLICACIÓN</b>	FORD / MAZDA, 4L 1.6L SOHC 8v
<b>APLICACION</b>	

**MS-4303-3NS**



<b>APLICACIÓN</b>	FORD, 4L 2.0L SOHC 8V
<b>APLICACION</b>	

**MS-4318-1E**



<b>APLICACIÓN</b>	FORD/MAZDA/MERCURY, V6 3.0L OHV 12V
<b>APLICACION</b>	

**MS-4335-2P**

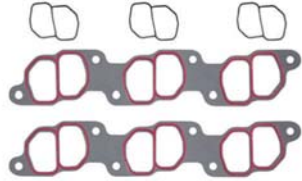

<b>APLICACIÓN</b>	FORD/MAZDA, V6 4.0L OHV 12V
<b>APLICACION</b>	

**MS-4126-E**



<b>APLICACIÓN</b>	GM/CHEVROLET, 4L 2.8L DOHC 16V; LK5
<b>APLICACION</b>	

**MS-4126**

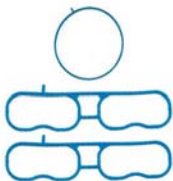

<b>APLICACIÓN</b>	GM/CHEVROLET, 4L 2.8L/2.9L DOHC 16V
<b>APLICACION</b>	

**MS-4127-E**



<b>APLICACIÓN</b>	GM/CHEVROLET, 4L 2.9 L 178" DOHC 16V
<b>APLICACION</b>	



**MS-4128**

<b>APLICACIÓN</b>	GM/CHEVROLET, 5L 3.5L/3.7L DOHC 20 V
<b>APLICACION</b>	

**MS-4129-E**

<b>APLICACIÓN</b>	GM/CHEVROLET, 5L 3.7L DOHC 20V
<b>APLICACION</b>	

**MS-4175-1A**

<b>APLICACIÓN</b>	GM/CHEVROLET, V8 4.8L/5.3L/5.7L/6.0L OHV 16V
<b>APLICACION</b>	

**MS-4175-2NS**

<b>APLICACIÓN</b>	GM/CHEVROLET, V8 5.3L OHV 16V
<b>APLICACION</b>	

**MS-4175-A**

<b>APLICACIÓN</b>	GM/CHEVROLET, V8 5.7L OHV 16V
<b>APLICACION</b>	

**MS-4176-1LS**

<b>APLICACIÓN</b>	GM/CHEVROLET, V8 6.0L/6.2L OHV 16V 6.0L/6.2L
<b>APLICACION</b>	

**MS-41457-3**

<b>APLICACIÓN</b>	HONDA / ACURA, 4L 2.2L SOHC 16V; F22B2
<b>APLICACION</b>	

**MS-41457-1**

<b>APLICACIÓN</b>	HONDA, 4L 2.2L/2.3L SOHC 16V
<b>APLICACION</b>	

**MS-4247-E**

<b>APLICACIÓN</b>	MITSUBISHI, 4L 2.4L SOHC 16V, 4G69
<b>APLICACION</b>	

**MS-4247-A**

<b>APLICACIÓN</b>	MITSUBISHI, 4L 2.4L SOHC 16V; 4G69
<b>APLICACION</b>	

**MS-41244-A**

<b>APLICACIÓN</b>	NISSAN/INFINITY, V6 3.0L DOHC 24V; VQ30DE
<b>APLICACION</b>	

**MS-41229-1P**

<b>APLICACIÓN</b>	NISSAN / MERCURY, V6 3.0L,3.3L SOHC 12V
<b>APLICACION</b>	

**MS-41229-A**

<b>APLICACIÓN</b>	NISSAN / MERCURY, V6 3.3L SOHC 12V
<b>APLICACION</b>	

**MS-496-E**

<b>APLICACIÓN</b>	SUZUKI, 4L 1.5L DOHC 16V; M15A
<b>APLICACION</b>	

**MS-496-R**

<b>APLICACIÓN</b>	SUZUKI, 4L 1.5 L DOHC 16V; M15A
<b>APLICACION</b>	



**MS-41354**



**APLICACIÓN** TOYOTA, 4L 2.7L DOHC 16V;  
**APLICACION** 2TRFE

**MS-41316**

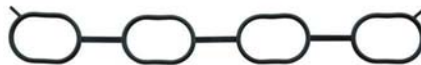

**APLICACIÓN** TOYOTA, 4L 1.5L DOHC 16V;  
**APLICACION** 1NZFE

**MS-41856-E**



**APLICACIÓN** VOLKSWAGEN, 5L 2.5L 151"  
**APLICACION** DOHC 20V;CBTA, CBUA, BGP

**OS-1251-1**



**APLICACIÓN** CHRYSLER/MITSUBISHI, 4L  
**APLICACION** 2.4L SOHC 16V

**RE-16317-V**



**APLICACIÓN** FORD, 4L 1.6L SOHC 8V;  
**APLICACION** ZETEC ROCAM

**RE-16122-S**



**APLICACIÓN** TOYOTA, 4L 2.2L DOHC 16V  
**APLICACION**

**RE-16058**



**APLICACIÓN** NISSAN, 4L 1.6L "GA16DE"  
**APLICACION**

**SS-8273-1V**



**APLICACIÓN** CHRYSLER/DODGE / JEEP, V8  
**APLICACION** 5.7L OHV 16v; HEMI

**SS-8357-3V**



**APLICACIÓN** FORD/LINCOLN/MERCURY, V8  
**APLICACION** 4.6L/5.4L 32V/24V DOHC

**SS-81353-S**



**APLICACIÓN** TOYOTA, V6 2.5L/3.0L  
**APLICACION**

**SV-81236-V**



**APLICACIÓN** NISSAN, V6 2.5L/3.5L, DOHC  
**APLICACION** QR25DE, VQ35DE

**SV-81459-V**



**APLICACIÓN** HONDA/ACURA, 4L 1.7L SOHC  
**APLICACION** 12V; D17A1/2/6/7

**TC-6133**



**APLICACIÓN** GMC/SUZUKI, 4L DOHC, 16  
**APLICACION** V 2.0 L

**TC-61467**



**APLICACIÓN** HONDA /ACURA/STERLING,  
**APLICACION** V6 2.5L/2.7L

**VS-396-R**

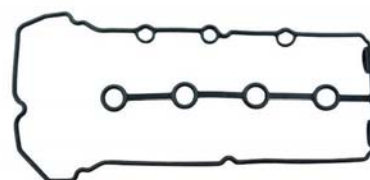

**APLICACIÓN** SUZUKI, 4L 1.5L 91" DOHC  
**APLICACION** 16V; M15A





**VS-3242-R**

<b>APLICACIÓN</b>	CHRYSLER/DODGE, 4L 2.0L DOHC 16V.
<b>APLICACION</b>	

**VS-3269-R**

<b>APLICACIÓN</b>	CHRYSLER/DODGE., V6 3.6L DOHC 24V; PENTASTAR.
<b>APLICACION</b>	

**VS-3330-R**

<b>APLICACIÓN</b>	FORD, V6 3.8L OHV 12V.
<b>APLICACION</b>	

**VS-3127-R**

<b>APLICACIÓN</b>	GMC/CHEVROLET, 4L 2.9L 178" DOHC 16V
<b>APLICACION</b>	

**VS-3129-R**

<b>APLICACIÓN</b>	GMC/CHEVROLET, 5L 3.7L 223" DOHC 20V
<b>APLICACION</b>	

**VS-3153-1R**

<b>APLICACIÓN</b>	GMC/CHEVROLET, 6L 4.2L 254" DOHC 24V; LL8
<b>APLICACION</b>	

**VS-3154-R**

<b>APLICACIÓN</b>	GM/CHEVROLET, L5 3.5L DOHC, 20V.
<b>APLICACION</b>	

**VS-3167-2S**

<b>APLICACIÓN</b>	GM/CHEVROLET, V8 7.4L OHV 16V.
<b>APLICACION</b>	

**VS-31750-1R**

<b>APLICACIÓN</b>	HONDA / ACURA, V6 3.2L SOHC 24V.
<b>APLICACION</b>	

**VS-31461-R**

<b>APLICACIÓN</b>	HONDA / ACURA, 4L 2.0L/1.8L 16V; B20Z2.
<b>APLICACION</b>	

**VS-31242-R**

<b>APLICACIÓN</b>	NISSAN, 4L 1.6L DOHC 16V; HR16DE.
<b>APLICACION</b>	

**VS-31245-R**

<b>APLICACIÓN</b>	NISSAN, 4L 2.5L DOHC 16V; QR25DE.
<b>APLICACION</b>	

**VS-3402-1R**

<b>APLICACIÓN</b>	SUZUKI /GEO/CHEVROLET, 4L 1.6L SOHC 16V .
<b>APLICACION</b>	

**VS-31369-R**

<b>APLICACIÓN</b>	TOYOTA/LEXUS, V8 5.7L DOHC 32V; 3UR-FE.
<b>APLICACION</b>	

**VS-31354-R**

<b>APLICACIÓN</b>	TOYOTA, 4L 2.7L DOHC 16V; 2TRFE.
<b>APLICACION</b>	



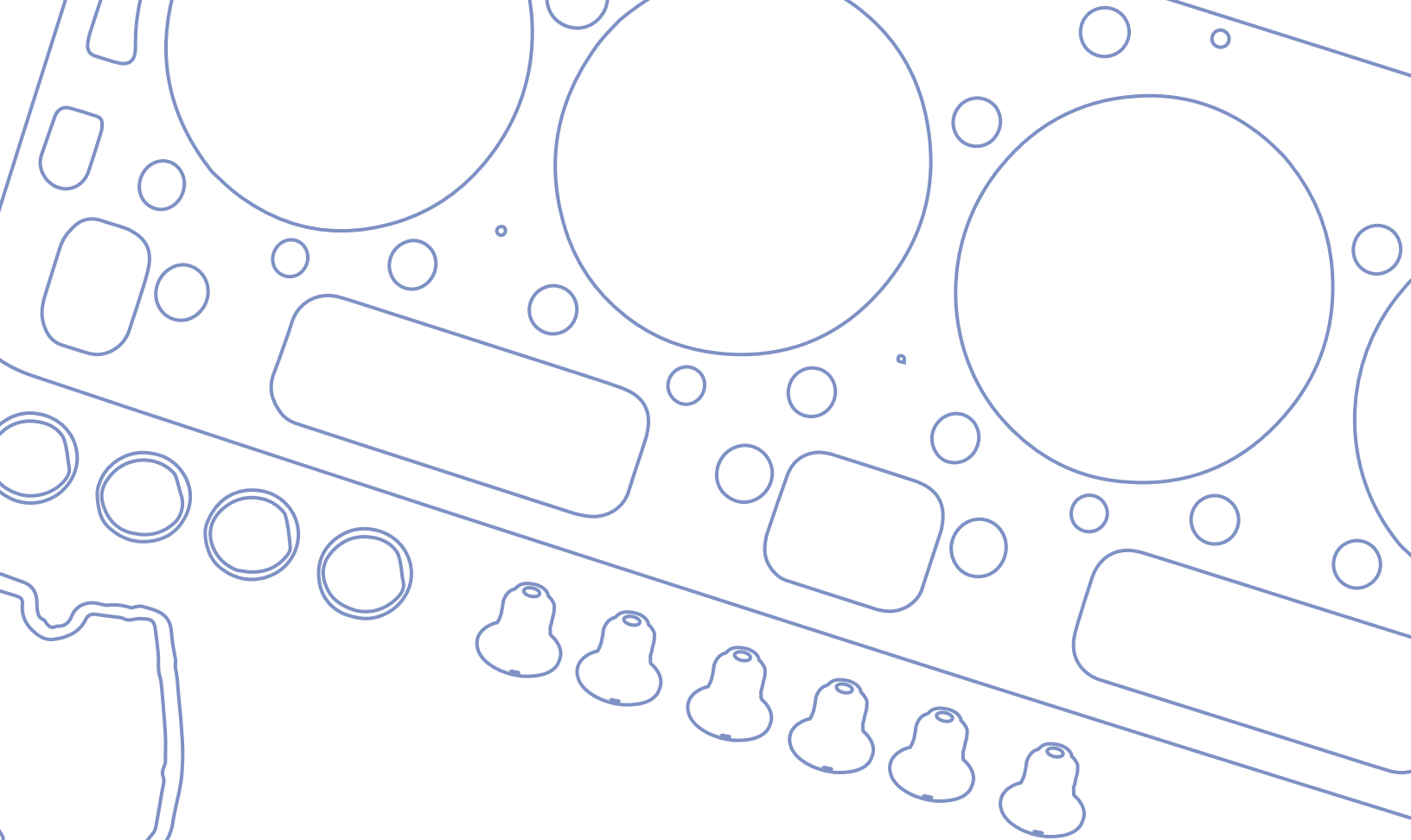

— ■ **INTERCAMBIOS**  
*/INTERCHANGES*

**SECCIÓN**  
**/SECTION**

CATÁLOGO DE APLICACIONES / APPLICATION CATALOG

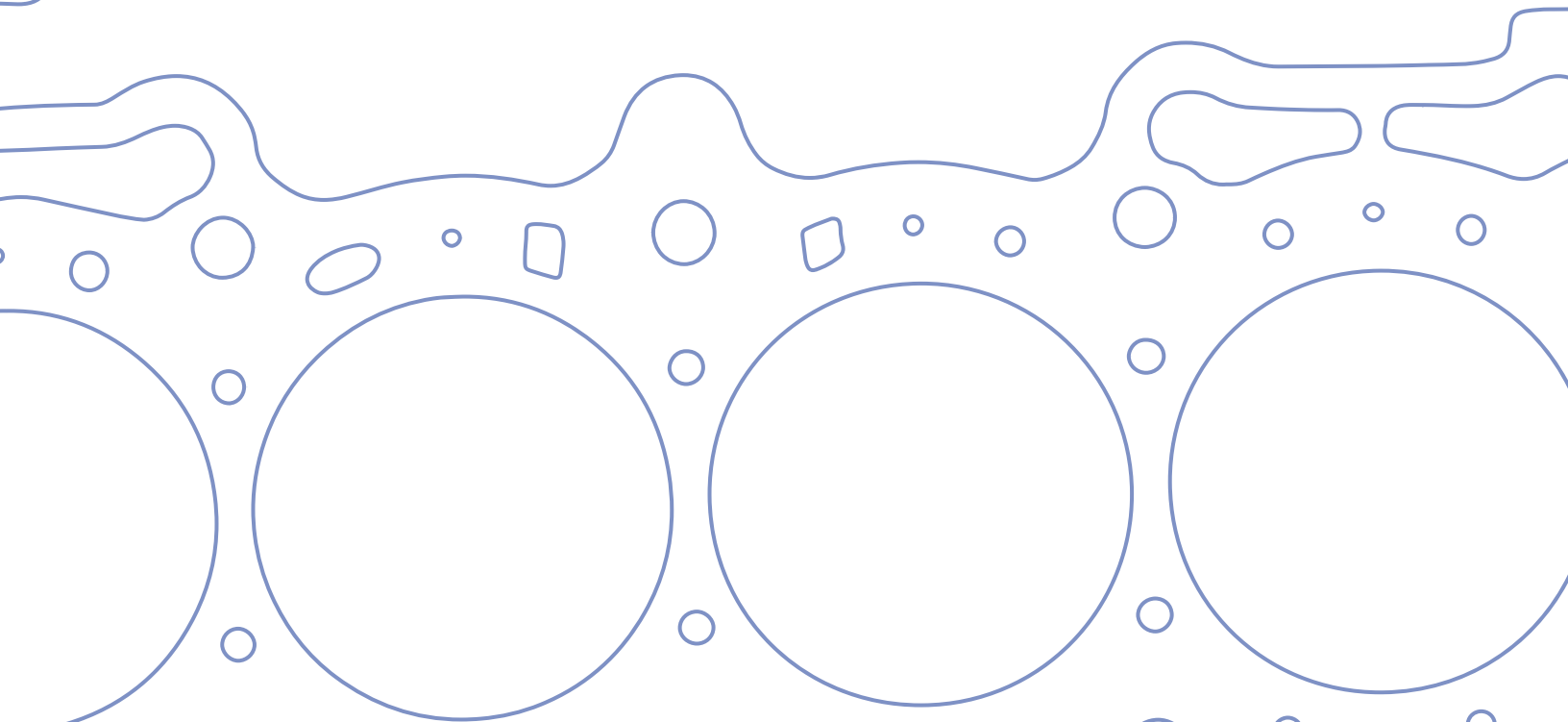





**■ JUEGOS COMPLETOS / FULL SETS**

# TF VICTOR	# FELPRO/MEX	# DC	# TF VICTOR	# FELPRO/MEX	# DC
JC-10	FSHS26255PT	FS-001234-1	JC-1303	FS21187PT1	FS-001310
JC-100	JSE41800	FS-001852	JC-1304	JTO422001	FS-001320
JC-102	JVWB52500	FS-001856-ML	JC-1305	JTO422003	FS-001320-1
JC-112	FSHS26197PT	FS-000203-ML	JC-1306	JTO422002	FS-001320-2
JC-114	JCH415ATT	FS-000204-ML	JC-1308	FSHS26232PT	FS-001326
JC-115	FSHS9388PT1	FS-000202	JC-1403-K	JCH62251	FS-000220-1
JC-1204	JGM420001	FS-000117	JC-1403-K2	JCH62252	FS-000225-1
JC-1205-2	JGM62501	FS-000130	JC-1405	JCH42500	FS-000240-1
JC-1206	JGM6173	FS-000140-1	JC-1406	JCH422002	FS-000240-2
JC-1207	JGM6181	FS-000142-1	JC-1407	FSHS26332PT	FS-000226-ML
JC-1208	JGM631001	FS-000141	JC-1408	JCH420007	FS-000242
JC-1212	JGM422001	FS-000107-1	JC-1408-1	JCH420006	FS-000242-1
JC-1215	JGMC41600	FS-000100-1	JC-1409	JCH63900	FS-000270
JC-1216	JGM41341	FS-000108-2	JC-1410	JCH63300	FS-000254
JC-1216-1	JGM41342	FS-000112-1	JC-1411	JCH424002	FS-000245
JC-1217	JGM41511	FS-000106	JC-1412	JCH63500	FS-000261
JC-1219	JGM41512	FS-000105-2	JC-1413	FS8770PT	FS-000250
JC-1222	JGM6262	FS-000144-1	JC-1414	JCH6181	FS-000253-1
JC-1222-1	JGM62621	FS-000144	JC-1415	JDH100D42500	FS-000206-D
JC-1222-2	FS9354PT1	FS-000144-5	JC-1416	JCH633002	FS-000263
JC-1222-3	FS9354PT2	FS-000144-3	JC-1417	FSHS26229PT	FS-000271
JC-1222-7	JGM64300	FS-000144-7	JC-1417	FSHS26229PT	FS-000271-ML
JC-1223	JGM63100	FS-000145-2	JC-1418	JCH62500	FS-000252
JC-1223-1	JGM631003	FS-000145-1	JC-1419	JCH84700	FS-000272
JC-1225	JGM418003	FS-000118	JC-1419	JCH84700	FS-000272-ML
JC-1228	JGM42000	FS-000117-ML	JC-1420	FSHS26284PT	FS-000273-ML
JC-1229	JGM42200	FS-000113-G	JC-1420	FSHS26284PT	FS-000273
JC-1232	JGM42400	FS-000109-1	JC-1431-1	JCH83182	FS-000260-1
JC-1234	JPO41000	FS-000116	JC-1432-K	JCH83601	FS-000260-2
JC-1239	FSHS26379PT	FS-000102-1G	JC-1434	JCH85900	FS-000275-1
JC-1239	FSHS26379PT	FS-000102-1ML	JC-1434-1	FSHS9898PT2	FS-000275-2
JC-1240	FSHS26336PT	FS-000128-ML	JC-1502-2R	JFO42300	FS-000300
JC-1241	FSHS26390PT	FS-000129-ML	JC-1503-2R	JFO423002	FS-000300-1
JC-1252-1	JGM83502	FS-000150-M	JC-1504	JFO4140	FS-000305
JC-1252-K	JGM8350	FS-000150-5	JC-1504-1	FS9063PT	FS-000306
JC-1253	JGM8305	FS-000160	JC-1505	JFO41600	FS-000303
JC-1254	FSHS26213PT	FS-000153-ML	JC-1505-1	JFO41900	FS-000303-2
JC-1254	FSHS26213PT	FS-000153	JC-1507	JFO420001	FS-000313-1
JC-1258	JGM8454	FS-000167	JC-1508	JFO413FTA	FS-000302
JC-1258	JGM8454	FS-000168-2	JC-1509	JFO41400	FS-000307-ML
JC-1258-1	JGM84541	FS-000168-1	JC-1510	FS7916PT2	FS-000320
JC-1258-1	JGM84541	FS-000169	JC-1510-1	FS7916PT3	FS-000320-1
JC-1259	JGM83503	FS-000150-10	JC-1511	JFO420ECO	FS-000348-1ML
JC-1260-1	JGM63400	FS-000173-1	JC-1511	JFO420ECO	FS-000348-1
JC-1261	FS26168PT	FS-000181	JC-1512-R	JFO6240	FS-000325



## ■ JUEGOS COMPLETOS / FULL SETS

# TF VICTOR	# FELPRO/MEX	# DC	# TF VICTOR	# FELPRO/MEX	# DC
JC-1512-R	JFO6240	FS-000325-1	JC-1807-K	JAM6282	FS-000710-1
JC-1512-R	JFO6240	FS-000325-3	JC-19	JNI416002	FS-001216
JC-1513-1R	JFO62302	FS-000330-1	JC-20	JNI42400	FS-001225
JC-1513-R	JFO62301	FS-000330	JC-201	JNI4KM	FS-001550-G
JC-1514	JFO638002	FS-000332	JC-201	JNI4KM	FS-001550
JC-1514	JFO638002	FS-000330-2	JC-21	JNI4GA16	FS-001226
JC-1515	JFO63000	FS-000318	JC-22	JNIT41800	FS-001238
JC-1515	JFO63000	FS-000318-1	JC-23	JNI4Z24	FS-001224
JC-1516	JFO6177	FS-000308	JC-25	JNI63000	FS-001229
JC-1518	JFO61712	FS-000315	JC-251	JPE41600	FS-001900
JC-1519	JFO420002	FS-000303-5	JC-26	JNI420002	FS-001228
JC-1520	JFO638003	FS-000332-2	JC-27	JNI42000	FS-001218
JC-1520	JFO638003	FS-000330-4	JC-30	JNIU42400	FS-001232
JC-1520-1	JFO638004	FS-000341	JC-31	FSHS26255PT1	FS-001234
JC-1520-2	JFO638007	FS-000341-1	JC-32	FSCS26192	FS-001229-1
JC-1520-3	JFO638005	FS-000341-2	JC-34	FSHS26261PT	FS-001235-ML
JC-1521	FSHS9539PT1	FS-000303-4	JC-34	FSHS26261PT	FS-001235-G
JC-1522	JFO420004	FS-000348	JC-37	JNIUD63000	FS-001240
JC-1523	JFO416001	FS-000317	JC-38	JNICD42500	FS-001241-ML
JC-1524	FSHS26250PT	FS-000305-9	JC-40	FSHS26372PT	FS-001256-ML
JC-1525	FSHS9081PT1	FS-000335	JC-50	FS9915PT1	FS-001455
JC-1527	FSHS9902PT3	FS-000322-2	JC-50-1	26337PT	FS-001459-ML
JC-1531-K	JFO8352	FS-000355-1	JC-70-2	JGM42500	FS-001420-2
JC-1531-K	JFO8352	FS-000355	JC-90	JVWE52500	FS-001851
JC-1532	FSHS9790PT8	FS-000356-2	JC-91	JVW416	FS-001835-G
JC-1532-1	FSHS9792PT9	FS-000356-2E	JC-92	JVW416002	FS-001830
JC-1533-1R	JFO83023	FS-000360-5	JC-94	JVWP41800	FS-001840-1
JC-1533-T	JFO83021	FS-000362	JC-98-R	JVW416001	FS-001820-1
JC-1535	FSHS9293PT1	FS-000337-G	JC-98-R	JVW416004	FS-001820-1
JC-1535-1	FSHS9293PT2	FS-000337-1ML	JC-99	JVW42000	FS-001845-1
JC-1536	FSHS8548PT14	FS-000360-6	JC-99-1	JVWC42000	FS-001850-ML
JC-1537	JFO83511	FS-000365-1			
JC-1537-1R	JFO83513	FS-000365-3			
JC-1537-R	JFO83512	FS-000365-2			
JC-1538	JFO638008	FS-000341-3			
JC-1539	JFO8400	FS-000370			
JC-1540	FS8265PT3	FS-000375			
JC-1541	JFO8280	FS-000356			
JC-1544	JFO106800	FS-000390			
JC-1544-1	JFO1068001	FS-000390-1			
JC-1545	JFO854001	FS-000356-3ML			
JC-1545	JFO854001	FS-000356-3			
JC-1545-1	JFO854002	FS-000356-4			
JC-1545-2	FSHS26306PT	FS-000357			
JC-1806-K	JAM6258	FS-000710			

**■ JUNTAS DE CABEZA / HEAD GASKETS**

# TF VICTOR	# FELPRO/MEX	# DC	# TF VICTOR	# FELPRO/MEX	# DC
CA-100	CSE41800	CA-001852-G	CA-1412-I	CCH63500I	CA-000261-G
CA-102	CVWB52500	CA-001856-G	CA-1414	CCH6181	CA-000253-G
CA-115	9388PT	CA-000202-G	CA-1416-1-D	9996PT	CA-000255-1G
CA-1205-K	CGM6250	CA-000130-G	CA-1416-1-I	9997PT	CA-000254-1G
CA-1206	CGM6173	CA-000140-G	CA-1416-D	9536PT	CA-000263-G
CA-1207	8723PT1	CA-000142-G	CA-1416-I	9535PT	CA-000264-G
CA-1208-VC	CGM63100	CA-000141-G	CA-1417	26229PT	CA-000271-G
CA-1211	CAM4151	CA-000105-G	CA-1418	9037PT	CA-000252-G
CA-1212	CGM422001	CA-000107-G	CA-1431	CCH8360	CA-000260-G
CA-1213	CGMC41400	CA-000100-G	CA-1434	CCH85200	CA-000275-G
CA-1216	9170PT1	CA-000108-G	CA-1439	26211PT	CA-000715-G
CA-1222	9354PT1	CA-000144-G	CA-1504	9063PT	CA-000306-G
CA-1223	CGM631001	CA-000145-G	CA-1505	CFO41600	CA-000303-G
CA-1225	CGM418003	CA-000118-G	CA-1508	CFO41300	HG35210
CA-1227	CGMA41800	CA-000114-G	CA-1508	CFO41300	CA-000302-G
CA-1228	CGM420001	CA-000117-G	CA-1509	CFO41400	CA-000307-G
CA-1232	9059PT	CA-000109-G	CA-1510	CFO6200	CA-000320-G
CA-1232	9059PT	CA-000109-1G	CA-1512	CFO6240	CA-000325-G
CA-1234	CPO41000	CA-000116-G	CA-1513	CFO62301	CA-000330-G
CA-1235-D	CGM63800D	CA-000149-G	CA-1514	CFO63800	CA-000332-G
CA-1235-I	9917PT	CA-000148-G	CA-1514	CFO63800	CA-000331-1G
CA-1250-VC	CGM8350	CA-000150-G	CA-1515	CFO63000	CA-000318-G
CA-1253	CGM8305	CA-000160-G	CA-1516-D	9510PT	CA-000309-G
CA-1254	26213PT	CA-000153-G	CA-1516-I	9511PT	CA-000308-G
CA-1254	26214PT	CA-000153-G	CA-1518-D	9132PT	CA-000316-G
CA-1258-1	CGM84541	CA-000169-G	CA-1518-I	9136PT	CA-000315-G
CA-1260	9071PT	CA-000173-G	CA-1519	9539PT	CA-000303-1G
CA-1261-D	26169PT	CA-000181-G	CA-1520-D	9253PT	CA-000342-G
CA-1261-I	26168PT	CA-000182-G	CA-1520-I	9250PT	CA-000341-G
CA-1262	26191PT	CA-000175-G	CA-1523	CFO416001	CA-000317-G
CA-1262	9292PT	CA-000175-G	CA-1524	26250PT	CA-000305-G
CA-1264	26192PT	CA-000176-G	CA-1527-D	CFO6183D	CA-000323-G
CA-1301	26185PT	CA-001320-GX	CA-1527-I	CFO6183I	CA-000322-G
CA-1301	26185PT	CA-001320-GX1	CA-1531-K	CFO8352	CA-000355-G
CA-1301	26185PT	CA-001320-G	CA-1535-I	26301PT	CA-000337-G
CA-1309	9465PT	CA-001352-G	CA-1539	CFO8400	CA-000370-G
CA-1309	9465PT	CA-001330-G	CA-1540	8558PT1	CA-000375-G
CA-1401	26206PT	CA-000245-1G	CA-1540	8558PT1	CA-000380-G
CA-1406	CCH42500	CA-000240-G	CA-1541-D	9790PT2	CA-000357-G
CA-1408	9922PT	CA-000242-G	CA-1541-I	9792PT2	CA-000356-G
CA-1409	9910PT	CA-000270-G	CA-1544-D	26305PT	CA-000391-G
CA-1410-D	CCH63300D	CA-000255-G	CA-17	CNI416001	CA-001210-G
CA-1410-I	CCH63300I	CA-000254-G	CA-18	CNI41800	CA-001215-G
CA-1411	9924PT	CA-000245-G	CA-1806-VC	CAM6258	CA-000710-G
CA-1412-D	CCH63500D	CA-000262-G	CA-1807-VC	CAM6282	CA-000710-G



## ■ JUNTAS DE CABEZA / HEAD GASKETS

# TF VICTOR	# FELPRO/MEX	# DC	# TF VICTOR	# FELPRO/MEX	# DC
CA-19-G	CNI416002	CA-001216-G	CA-1411	9924PT	CA-000242-1ML
CA-20	CNI42400	CA-001225-G	CA-1416-1-D	9996PT	CA-000263-ML
CA-201	CNI4KM	CA-001550-G	CA-1416-1-I	9997PT	CA-000264-ML
CA-21	9819PT	CA-001226-G	CA-1417	26229PT	CA-000271-ML
CA-22	CNIT41800	CA-001238-G	CA-1419	26157PT	CA-000272-ML
CA-22	CNIT41800	CA-001238-GX	CA-1438-D	26208PT	CA-000268-1ML
CA-23	9210PT1	CA-001224-G	CA-1438-I	26209PT	CA-000268-ML
CA-23	9210PT1	CA-001224-GX	CA-1439	26211PT	CA-000715-ML
CA-24	8769B2	CA-001222-G	CA-1506	9717PT	CA-000303-2ML
CA-25	9571PT	CA-001229-G	CA-1509	CFO41400	CA-000307-ML
CA-26	9816PT	CA-001228-G	CA-1517-D	9038PT	CA-000311-ML
CA-27	21178PT	CA-001218-G	CA-1517-I	9039PT	CA-000312-ML
CA-30	CNIU42400	CA-001232-G	CA-1519	9539PT	CA-000303-1ML
CA-32	26219PT	CA-001229-1G	CA-1520-D	9253PT	CA-000342-ML
CA-33	26171PT	CA-001233-G	CA-1520-I	9250PT	CA-000341-ML
CA-34	26261PT	CA-001235-GX	CA-1526-D	26212PT	CA-000327-ML
CA-34	26261PT	CA-001235-G	CA-1526-I	26233PT	CA-000326-ML
CA-50	9915PT	CA-001455-G	CA-1535-I	26301PT	CA-000337-ML
CA-50-1	26236PT	CA-001459-G	CA-1544-D	26305PT	CA-000391-ML
CA-50-2	9274PT	CA-001454-G	CA-1544-I	26304PT	CA-000356-ML1
CA-51-1	9958PT1	CA-001463-GX	CA-1544-I	26304PT	CA-000390-ML
CA-51-1	9958PT1	CA-001463-G	CA-1545-D	26307PT	CA-000357-ML
CA-54	26243PT	CA-001466-G	CA-1545-I	26306PT	CA-000356-ML
CA-70-VC	CGM42100	CA-001420-G	CA-203	CRN42000	CA-001555-ML
CA-85-G	CRE41300	CA-001520-G	CA-22	CNIT41800	CA-001238-ML
CA-91	CVW416	CA-001835-G	CA-251	CPE41600	CA-001900-ML
CA-92-G	CVW416002	CA-001830-G	CA-34	26261PT	CA-001235-ML
CA-95	CVO62800	CA-001854-G	CA-35-D	26240PT	CA-001236-1ML
CA-99	9570PT	CA-001845-G	CA-35-D	26240PT	CA-001239-ML
CA-99-1	26161PT	CA-001850-G	CA-35-I	26239PT	CA-001239-1ML
CA-100	CSE41800	CA-001852-ML	CA-35-I	26239PT	CA-001236-ML
CA-102	CVWB52500	CA-001856-ML	CA-37-GR1	CNIUD6300065	CA-001243-ML
CA-112	26197PT	CA-000203-ML	CA-50	9915PT	CA-001455-ML
CA-113	26224PT	CA-000204-ML	CA-50-1	26236PT	CA-001459-ML
CA-1227	CGMA41800	CA-000114-ML	CA-50-2	9274PT	CA-001454-ML
CA-1229	CGM42200	CA-000113-ML	CA-51-1	9958PT1	CA-001463-ML
CA-1254	26213PT	CA-000153-ML	CA-54	26243PT	CA-001466-ML
CA-1254	26214PT	CA-000153-ML	CA-91	CVW416	CA-001835-ML
CA-1264	26192PT	CA-000176-ML	CA-99	9570PT	CA-001845-ML
CA-1308	26232PT	CA-001328-ML	CA-99-1	26161PT	CA-001850-ML1
CA-1401	26206PT	CA-000245-1ML	CA-99-1	26161PT	CA-001850-ML
CA-1401	26206PT	CA-000245-ML			
CA-1407	26332PT	CA-000226-ML			
CA-1408	9922PT	CA-000242-1ML			
CA-1408-2	9036PT	CA-000242-ML			



**■ MULTIPLES / MANIFOLD GASKETS**

# TF VICTOR	# FELPRO/MEX	# DC	# TF VICTOR	# FELPRO/MEX	# DC
MU-4100-A	MS96151	MS-041852-A	MU-41259-A	MS90131	MS-004150-9
MU-4100-A	MS96151	MS-041852-1A	MU-41259-E	MS94054	MS-004150-3E
MU-4100-E	MS96116	MS-041852-E	MU-41261-E	MS96057	MS-004181-E
MU-4102-A	MS97007	MS-041856-A	MU-41262-E	MS92467	MS-004175-E
MU-4102-E	MS97034	MS-041856-E	MU-41262-E	MS92467	MS-004152-E
MU-4112-E	MS96162	MS-004203-1E	MU-41303-E	MS90832	MS-041310-E
MU-4113-A	MS96331	MS-004203-A	MU-41305-E	MS91679	MS-041320-E
MU-4113-E	MS96332	MS-004203-E	MU-41307-A	MS93942	MS-041302
MU-4113-E	MS96332	MS-004204-E	MU-41308-A	MS94295	MS-041325
MU-4115-A	MS929641	MS-004235	MU-41308-E	MS941401	MS-041325-E
MU-4115-E	MS94841	MS-004235-E	MU-41309-A	MS92692	MS-041330
MU-41205	MGM6250	MS-004130-1	MU-41309-E	MS92721	MS-041330-E
MU-41206	MGM6173A	MS-004140-A	MU-41309-E	MS92721	MS-041330-LSE
MU-41206-E	MGM6173E	MS-004140-E	MU-41401-A	MS92888	MS-004245-2
MU-41207-E	MS90508	MS-004142-1E	MU-41401-A	MS92888	MS-004245-1
MU-41208-A	MGM63100A	MS-004141-A	MU-41401-E	MS92846	MS-004245-1E
MU-41208-E	MGM63100E	MS-004141-E	MU-41403-K	MCH6225	MS-004220
MU-41212-A	MS90543	MS-004107-1	MU-41407-A	MS96840	MS-004226-A
MU-41212-E	MS90540	MS-004107-E	MU-41407-E	MS96902	MS-004226-E
MU-41212-E	MS90540	MS-004117-1E	MU-41408-1A	MS90708	MS-004243-3P
MU-41213-E	MGM41400E	MS-004100-E	MU-41408-2E	MS95674	MS-004243-E
MU-41216-A	MS95393	MS-004108-1	MU-41408-2E	MS95674	MS-004243-1E
MU-41216-E	MGM4121E	MS-004108-E	MU-41409-A	MS95315	MS-004270
MU-41222-7-A	MS95817	MS-004144-4	MU-41410-1-A	MS928081	MS-004254-A
MU-41222-7-A	MS95817	MS-004144-5	MU-41410-E	MS94666	MS-004254-E
MU-41222-7-E	MS95842	MS-004144-1E	MU-41411-A	MCH42400A	MS-004242
MU-41223-1A	MS90565	MS-004145-1	MU-41411-A	MCH42400A	MS-004242-1P
MU-41223-1P	MS90562	MS-004145-1P	MU-41411-A	MCH42400A	MS-004243-2P
MU-41223-1P	MS90562	MS-004145-1	MU-41411-S	MCH424001A	MS-004242-1P
MU-41223-E	MS95586	MS-004145-E	MU-41412-A	MS95444	MS-004261
MU-41232-A	MS95839	MS-004109-1NS	MU-41412-A	MS95444	MS-004261-1
MU-41232-E	MS90278	MS-004109-E	MU-41412-E	MS95446	MS-004268-E
MU-41232-E	MS90284	MS-004109-E	MU-41412-E	MS95446	MS-004262-E
MU-41235-A	MS958091	MS-004148-NS1	MU-41414-A	MS93795	MS-004253-1
MU-41235-A	MS958091	MS-004149-2NS	MU-41414-E	MS93797	MS-004253-E
MU-41235-E	MS95829	MS-004148-E	MU-41414-E	MS93797	MS-004253-2E
MU-41235-P	MS95746	MS-004148-P	MU-41415-AE	MDH100D42500A	MS-004206-D
MU-41250-E	MGM8350E	MS-004150-E	MU-41417-A	MS932051	MS-004271
MU-41252-1-A	MGM83501A	MS-004150-6	MU-41417-E	MS96344	MS-004271-E
MU-41254-E	MS96302	MS-004153-E	MU-41418-P	MS95708	MS-004252-P
MU-41254-E	MS96707	MS-004153-E	MU-41419-A	MS93205	MS-004272
MU-41258-1A	MS95826	MS-004169	MU-41419-E	MS93217	MS-004272-E
MU-41258-1E	MS95840	MS-004169-E	MU-41420-A	MS96574	MS-004273
MU-41258-1P	MS95787	MS-004169-P	MU-41432-A	MCH8360A	MS-004260-1
MU-41259-A	MS90131	MS-004150-8	MU-41432-E	MCH8360E	MS-004260-E



## ■ MULTIPLES / MANIFOLD GASKETS

# TF VICTOR	# FELPRO/MEX	# DC	# TF VICTOR	# FELPRO/MEX	# DC
MU-41432-E	MCH8360E	MS-004261-E	MU-41520-P	MS95934	MS-004341-1P
MU-41434-1A	MS953921	MS-004275-1	MU-41521-A	MS94432	MS-004303-3
MU-41434-1A	MS953921	MS-004275-3	MU-41521-A	MS94432	MS-004303-3NS
MU-41434-A	MS95392	MS-004275	MU-41521-E	MS94427	MS-004313-1E
MU-41438-A	MS92165	MS-004261-2	MU-41524-A	MS96634	MS-004305-1
MU-41438-A	MS92165	MS-004261-2LS	MU-41524-E	MS96655	MS-004305-2P
MU-41438-A	MS92165	MS-004261-3	MU-41525-A	MS98005T	MS-004335-A
MU-41438-A	MS92165	MS-004261-3LS	MU-41525-E	MS94764	MS-004335-E
MU-41438-P	MS91990	MS-004261-2	MU-41526-A	MS925861	MS-004327
MU-41438-P	MS91990	MS-004261-3LS	MU-41526-A	MS925861	MS-004327-6
MU-41438-P	MS91990	MS-004261-3	MU-41527-A	MS953721	MS-004318
MU-41438-P	MS91990	MS-004261-3P	MU-41531	MFO8352A	MS-004355-A
MU-41438-P	MS91990	MS-004261-2LS	MU-41531-E	MS9812	MS-004355-E
MU-41438-P	MS91990	MS-004261-2P	MU-41533-1A	MFO8351A	MS-004361-A
MU-41502	MFO42300E	MS-004300	MU-41533-1A	MFO8351A	MS-004365-2
MU-41503-A	MFO423002A	MS-004300-1	MU-41533-1A	MFO8351A	MS-004361
MU-41504-1A	MS91617	MS-004306	MU-41533-1A	MFO8351A	MS-004361-2
MU-41505	MFO4116E	MS-004303	MU-41533-A	MFO8302A	MS-004360-A
MU-41505-1-A	MS93935	MS-004301-2	MU-41533-A	MFO8302A	MS-004362
MU-41507-A	MS90891	MS-004313-1	MU-41533-E	MFO8302E	MS-004360-E
MU-41507-E	MS95702	MS-004313-E	MU-41535-1A	MS96123	MS-004337-A
MU-41513-1A	MFO62301A	MS-004330-1	MU-41535-E	MS90779	MS-004337-E
MU-41513-E	MFO6230E	MS-004330-E	MU-41535-E	MS90779	MS-004337-LSE
MU-41514-A	MS940451	MS-004330-4	MU-41536-P	MS95953	MS-004360-3P
MU-41514-I	MFO62302A	MS-004330-2	MU-41538-E	MS95528	MS-004341-E
MU-41515-A	MFO63000A	MS-004318	MU-41541-1A	MS94801	MS-004357
MU-41515-E	MFO63000E	MS-004318-E	MU-41541-E	MFO8280E	MS-004357-E
MU-41515-E	MFO63000E	MS-004318-1E	MU-41544-1A	MS940141	MS-004390-1
MU-41516-A	MS93771	MS-004308-A	MU-41544-A	MS940121	MS-004390
MU-41516-E	MS93849	MS-004308-E	MU-41544-A	MS940121	MS-004390-1S
MU-41517-A	MS95726	MS-004311	MU-41544-E	MS941081	MS-004390-E
MU-41517-A	MS95726	MS-004327-2NS	MU-41545-1A-D	MS962811	MS-004357-2
MU-41517-E	MS95715	MS-004311-E	MU-41545-1A-D	MS962811	MS-004357-NS2
MU-41518-A	MS91886	MS-004315	MU-41545-A	MFO85400A	MS-004357-NS1
MU-41518-E	MFO61712E	MS-004315-E	MU-41545-A	MFO85400A	MS-004357-1
MU-41519-A	MS95918	MS-004303-2	MU-41545-P	MFO854001A	MS-004356-1P
MU-41520-1P	MS90812	MS-004341-2P	MU-41545-P	MFO854001A	MS-004356-NSP
MU-41520-A1-D	MS959851	MS-004341-1	MU-416	MNI41600	MS-041215
MU-41520-A1-D	MS959851	MS-004341-NS1	MU-416	MNI41600	MS-041200
MU-41520-A-D	MS95985	MS-004341-6	MU-41806	MAM6258	MS-004711
MU-41520-A-D	MS95985	MS-004341	MU-41806	MAM6258	MS-004710
MU-41520-A-D	MS95985	MS-004341-NSC	MU-419-1	MNI416002A	MS-041216-1E
MU-41520-A-D	MS95985	MS-004341-NS	MU-419-E	MNI416002E	MS-041216-E
MU-41520-P	MS95934	MS-004341-NSC	MU-420-E	MNI42400E	MS-041225-E
MU-41520-P	MS95934	MS-004341-6	MU-421-E	MS96343	MS-041226-E

**■ MULTIPLES / MANIFOLD GASKETS**

# TF VICTOR	# FELPRO/MEX	# DC
MU-421-E	MS96343	MS-041234-E
MU-422-A	MNI4Z22A	MS-041222
MU-422-A	MNI4Z22A	MS-041238
MU-422-E	MS90978	MS-041238-E
MU-423-A	MS93691	MS-041224-1
MU-425-A	MS922701	MS-041229-A
MU-425-E	MS92271	MS-041229-E
MU-426-E	MS96113	MS-041228-E
MU-427-1	MS226931	MS-041218
MU-431-A	MS96514	MS-041234
MU-432-A	MS922704	MS-041229
MU-433-A	MS954591	MS-041233-A
MU-434-A	MS96536	MS-041235-A
MU-434-E	MS96539	MS-041235-E
MU-435-A	MS96454	MS-041236-A
MU-435-E	MS91459	MS-041236-E
MU-490-A	MVWGL2500A	MS-041851
MU-490-E	MVWDP41000E	MS-041851-E
MU-492-A	MVW416002A	MS-041830-A
MU-492-A	MVW416002A	MS3880
MU-492-E	MVW416002E	MS-041830-E
MU-493	MVW41800A	MS-041840
MU-495-E	MS91963	MS-041854-E
MU-499-1-E	MS94356	MS-041845-1E

**■ JUNTAS TAPA DE PUNTERÍAS / VALVE COVER GASKETS**

# TF VICTOR	# FELPRO/MEX	# DC
PS-310	VS50618R	VS-031234-1R
PS-3100	VS50531R	VS-031852-R
PS-3102	VS50735R	VS-031856-R
PS-3111	PCH41000	VS-003201-R
PS-3112	VS50575R	VS-003203-R
PS-3113	VS50593R	VS-003204-R
PS-3115	VS50132R	VS-003235-R
PS-31205	PGM6250	VS-003130
PS-31206	PGM6173	VS-003140-R
PS-31206	PGM6173	VS-003140
PS-31208	PGM63100	VS-003141-R
PS-31208	PGM63100	VS-003141-S
PS-31212	VS50485R	VS-003107
PS-31213	PGM41400	VS-003100
PS-31216	VS50313R	VS-003108-R
PS-31222	VS50086R	VS-003144-R
PS-31222-7	VS50464R	VS-003144-1R
PS-31223	VS50442R	VS-003145-R
PS-31235	VS50080R	VS-003148-R
PS-31250	PGM8350	VS-003150
PS-31250	PGM8350	VS-003150-R
PS-31254	VS50484R	VS-003153-R
PS-31258-1	VS50388R	VS-003168-R
PS-31259	VS50088R	VS-003150-1R
PS-31261	VS50554R	VS-003181-R
PS-31262	VS50504R	VS-003175-R
PS-31262	VS50504R	VS-003152-R
PS-31308	VS50530R	VS-031325-R
PS-31309	VS50512R	VS-031330-R
PS-31401	VS50518R	VS-003245-R
PS-31403	PCH62251C	VS-003220
PS-31403-1	PCH62252C	VS-003225
PS-31404	VS50257C	VS-003240
PS-31405	PCH42500	VS-003240-1
PS-31406	PCH422001	VS-003240-S
PS-31406	PCH422001	VS-003240-2R
PS-31407	VS50698R	VS-003226-R
PS-31408	VS50457R	VS-003242
PS-31408	VS50457R	VS-003242-HD
PS-31408-1	PCH420004	VS-003242-R
PS-31409	VS50420R	VS-003270-HD
PS-31409	VS50420R	VS-003270
PS-31409	VS50420R	VS-003265-1R
PS-31410	PCH63300	VS-003254-HD
PS-31410	PCH63300	VS-003254-1R

**■ JUNTAS TAPA DE PUNTERÍAS / VALVE COVER GASKETS**

# TF VICTOR	# FELPRO/MEX	# DC	# TF VICTOR	# FELPRO/MEX	# DC
PS-31410-1	VS50599R	VS-003254-R	PS-31533	PFO8302R	VS-003360-HD
PS-31411	VS50459R	VS-003243-R	PS-31533	PFO8302R	VS-003360-R
PS-31412	VS50429R	VS-003261-HD	PS-31533-G	VS50029C	VS-003360-G
PS-31412	VS50429R	VS-003261-LR	PS-31535-1	VS50529R	VS-003337-2R
PS-31414	VS50026R1	VS-003253-R	PS-31535-D	VS50491R	VS-003337-1R
PS-31415	PDH100D42500	VS-003206-RD	PS-31539	PFO8400	VS-003370
PS-31416-1	VS50315R	VS-003254-3R	PS-31541-D	VS50377R	VS-003356-R
PS-31416-1	VS50315R	VS-003254-2R	PS-31543	VS50474R	VS-003375-1R
PS-31417-D	VS50594R	VS-003271-R	PS-31545-D	VS50481R	VS-003357-R
PS-31418	VS50461R	VS-003252-R	PS-316	PNI416001	VS-031210
PS-31419-D	VS50577R	VS-003272-R	PS-31806	VS50186C	VS-003710
PS-31420	VS50625R	VS-003273-R	PS-319	PNI416002	VS-031216-1R
PS-31431	PCH8360C	VS-003260-R	PS-319	PNI416002	VS-031216-R
PS-31431	PCH8360C	VS-003260	PS-319	PNI416002	VS-031216
PS-31431	PCH8360C	VS-003260-HD	PS-319	PNI416002	VS-031216-1
PS-31434	PCH85200	VS-003275-HD	PS-320	VS50042R	VS-031225
PS-31434	PCH85200	VS-003275	PS-320	VS50042R	VS-031225-R
PS-31434-1	VS50419R	VS-003275-R	PS-321	VS50383R	VS-031226-R
PS-31438	VS50689R	VS-003268-R	PS-321	VS50383R	VS-031226
PS-31438	VS50689R	VS-003261-2	PS-323	VS50246R	VS-031222
PS-31439	VS50458R	VS-003715-1R	PS-324-1	VS50343C	VS-031222-1
PS-31439	VS50522T	VS-003715-1R	PS-325	VS50251R1	VS-031229-R
PS-31503	PFO423002	VS-003300-1	PS-326	VS50384R	VS-031228-R
PS-31504-1	PFO4140	VS-003305	PS-327	PNI420001	VS-031218
PS-31505	VS50476R	VS-003303	PS-333-1	VS50385R	VS-031233-R
PS-31507	VS50460R	VS-003313-R	PS-334	VS50623R	VS-031235-R
PS-31507-1	VS50489R	VS-003313-1R	PS-335-D	VS50608R	VS-031236-R
PS-31510	VS12692	VS-003320	PS-354	VS50614R	VS-031466-1R
PS-31513	PFO62301	VS-003330	PS-354	VS50614R	VS-031466-R
PS-31514	VS50321R	VS-003330-1R	PS-370	PGM42100	VS-031420
PS-31514	VS50321R	VS-003330-1S	PS-392	PVW416002	VS-031830
PS-31515	PFO6183	VS-003318-1R	PS-394	VS50528R	VS-031840-R
PS-31515-1	VS50374R	VS-003318-R	PS-395	VS50643R	VS-031854-R
PS-31515-1	VS50374R	VS-003318	PS-396	PVW416001	VS-031810-1
PS-31516	VS50312C	VS-003308-R	PS-396	PVW416001	VS-031810
PS-31516	VS50312C	VS-003308			
PS-31517-D	VS50462R	VS-003311-R			
PS-31518	VS50115C	VS-003315			
PS-31520	VS50441R1	VS-003330-2R			
PS-31520	VS50441R1	VS-003330-3R			
PS-31521	VS50553R	VS-003313-3R			
PS-31522	VS50638R	VS-003348-R			
PS-31525	VS50368C	VS-003335			
PS-31525	VS50368C	VS-003335-1R			
PS-31533	PFO8302R	VS-003360			



**■ SELLOS DE CIGÜEÑAL / CRANK SEAL**

# TF VICTOR	# FELPRO/MEX	# DC
CO-91205-2SL	RGM8350	BS-007150-R
CO-91205-2SL	RGM8350	BS-007130-2
CO-91205-2SL	RGM8350	BS-007150
CO-91403-1KNT	RCH62251	BS-007220-R
CO-91403-KAS	BS40489	BS-007220
CO-91409-VT	BS40181	BS-007270-R
CO-91432-KPL	RCH8360	BS-007260
CO-91432-KPL	RCH8360	BS-007256-R
CO-91432-KPL	RCH8360	BS-007260-R
CO-91432-KPL	RCH8360	BS-007275-R
CO-91524-KAS	BS40651	BS-007256
CO-91524-KAS	BS40651	BS-007265
CO-91533-PL	RFO8302	BS-007321
CO-91533-PL	RFO8302	BS-007321-R
CO-91537-PL	RFO8351	BS-007370
CO-91537-PL	RFO8351	BS-007370-R
CO-91806-NT	RAM6258	BS-007710

**■ JUNTAS DE CARTER / OIL PAN SET**

# TF VICTOR	# FELPRO/MEX	# DC
CJ-11206	AGM6173	OS-001140
CJ-11208	OS34501R	OS-001140-1R
CJ-11208	OS34501R	OS-001140-1S
CJ-11213	AGM41400	OS-001100
CJ-11216	AGM4134	OS-001108
CJ-11222	OS34502R	OS-001144-R
CJ-11222	OS34502R	OS-001144
CJ-11222-7	OS30680R	OS-001144-1R
CJ-11223	OS30668R	OS-001145-R
CJ-11232	OS30678R	OS-001109-1
CJ-11235	OS30767R	OS-001148-R
CJ-11250	AGM83502	OS-001150
CJ-11250	AGM83502	OS-001160
CJ-11258-1	AGM8454	OS-001168-R
CJ-11259	AGM83503	OS-001150-1R
CJ-11259	AGM83503	OS-001150-R
CJ-11261	OS30714R	OS-001181-R
CJ-11262	OS30693R	OS-001175-1R
CJ-11262	OS30693R	OS-001175
CJ-11262	OS30693R	OS-001152
CJ-11301	OS20102C	OS-011310
CJ-11404	ACH42200	OS-001240
CJ-11405	ACH42500R	OS-001240-1S
CJ-11405	ACH42500R	OS-001240-1R
CJ-11405	ACH42500R	OS-001240-1C
CJ-11408	OS30673R	OS-001242-R
CJ-11408	OS30673R	OS-001242-HD
CJ-11409	OS34503R	OS-001270-R
CJ-11410-1	OS30622R	OS-001254-R
CJ-11411	OS30676R	OS-001245-HD
CJ-11412	OS30692R	OS-001261-R
CJ-11414	OS30570C	OS-001253
CJ-11415	ADH100D42500	OS-001250
CJ-11417	OS30743R	OS-001271-R
CJ-11418	OS30672C	OS-001252
CJ-11419	OS30709R	OS-001272-R
CJ-11420	OS30750R	OS-001273-1R
CJ-11432	ACH8360	OS-001256-3
CJ-11434	ACH83601	OS-001275-R
CJ-11439	OS34308R	OS-001715-R
CJ-115	ANI416001	OS-011200
CJ-11502	AFO42300	OS-001300
CJ-11502	AFO42300	OS-001300-2
CJ-11504-1	OS30297C	OS-001305
CJ-11505-1	OS30915R	OS-001303-2R



### ■ JUNTAS DE CARTER / OIL PAN SET

# TF VICTOR	# FELPRO/MEX	# DC
CJ-11505-1	OS30915R	OS-001303-1R
CJ-11507	OS30908C	OS-001313-R
CJ-11513	OS34000C	OS-001330
CJ-11513	OS34000C	OS-001330-1
CJ-11517	AFO62500	OS-001326-R
CJ-11518	OS30271C	OS-001315
CJ-11521	OS30711R	OS-001313-1R
CJ-11524	OS30814R	OS-001305-3R
CJ-11527-1	OS30712R	OS-001318-2R
CJ-11533	AFO8302	OS-001360
CJ-11536	OS34508R	OS-001360-1R
CJ-11537	AFO8351	OS-001365
CJ-11539	AFO8400	OS-001370
CJ-11544	OS30710R	OS-001390
CJ-11806	AAM6258	OS-001710
CJ-119	ANI416002	OS-011216
CJ-120	ANI42400	OS-011225
CJ-121	OS30619C	OS-011226
CJ-123	OS20042C	OS-011218
CJ-150	OS30691R	OS-011455-2R
CJ-150-1	OS30690R	OS-011459-R
CJ-150-1	OS30690R	OS-011455-1R
CJ-170-X	OS30409C	OS-011420-1
CJ-170-X	OS30409C	OS-011420
CJ-192	AVW416002	OS-011830
CJ-192	AVW416002	OS-011830-R

### ■ JUNTAS DE DISTRIBUCIÓN / TIMING COVER

# TF VICTOR	# FELPRO/MEX	# DC
DJ-81205	DGM6250	TC-006130
DJ-81206	DGM6173	TC-006140
DJ-81208	DGM63100	TC-006140-1
DJ-81216	TCS45793	TC-006108
DJ-81250	DGM8350	TC-006150-5
DJ-81403-X	TCS127691	TC-006220
DJ-81410	TCS458931	TC-006254
DJ-81410	TCS458931	TC-006254-1
DJ-81431	DCH8360	TC-006256
DJ-81434	TCS45996	TC-006270
DJ-81502	DFO42300	TC-006300
DJ-81513	DFO62302	TC-006330
DJ-81513	DFO62302	TC-006330-1
DJ-81516	TCS45791	TC-006308
DJ-81517	TCS45966	TC-006311
DJ-81533	DFO8302	TC-006360
DJ-81539	TCS45061	TC-006370
DJ-81541	TCS45869	TC-006356
DJ-81544	TCS45982	TC-006357
DJ-81544	TCS459821	TC-006357
DJ-81806	TCS45117	TC-006710
DJ-819	TCS45524	TC-061216
DJ-821	TCS45864	TC-061226

### ■ JUNTAS DE CARBURADOR / CARBURATOR GASKET

# TF VICTOR	# FELPRO/MEX	# DC
CR-902	FP902	DC-000902
CR-906	FP906	DC-000906
CR-919	FP919	DC-000919
CR-920	FP920	DC-000920
CR-924	FP924	DC-000924

# CATÁLOGO / CATALOG 2017

[www.dcp.com.mx](http://www.dcp.com.mx)

## VENTAS

• Tel. (477) 710 60 00  
• Lada sin costo 01 (800) 710 50 20  
ventas@dcp.com.mx

## CUSTOMER SERVICE

USA CONTACT: Toll Free • 1 877 676 7704  
Phone • 321 221 0443  
• email: cs@dcp.com.mx  
FUERA DE MÉXICO: (52) 477 7106007

## SERVICIO TÉCNICO / TECHNICAL SERVICE:

477 710 60 00  
email: soportetecnico@dcp.com.mx

MANUFACTURAS DIVERSAS S.A. de C.V.

