



ESPECIALISTAS EN INYECCIÓN

C-12-028

# FUEL INJECTION

CATÁLOGO 2019



"Pioneros en inyección de combustible en México"

Sensores|Válvulas|Cuerpos de aceleración|Inyectores|Repuestos de Inyección|Reguladores de gasolina|Pedal electrónico



# Visita nuestro sitios y consulta:

[www.tomco.com.mx](http://www.tomco.com.mx)



- Nuevos productos
- Catálogo electrónico
- Información de nuestra marca

## Suscríbete a nuestro canal:



- Videos técnicos
- Instalación correcta
- Pruebas



@TomcoMexico

- Contenido interesante

## Dale like a nuestra página:



Tomco Fuel Injection  
@tomcodemexico

- Contenido técnico
- Humor
- Frases
- Datos curiosos



Soporte técnico  
018008015042

¡Y mucho más!

"Pioneros en inyección de combustible en México"

# CATÁLOGO INYECCIÓN

4	BULBOS PARA MOTOVENTILADOR
7	CONECTORES PARA SENSORES
8	CUERPOS DE ACELERACIÓN ELECTRÓNICOS
11	CUERPOS DE INYECTORES
12	FILTRO INTERIOR PARA INYECTOR MULTIPORT
13	INDICADORES DE TEMPERATURA DEL MOTOR
16	INYECTORES PARA SISTEMA MULTIPORT
28	INYECTORES PARA SISTEMA TBI
29	JUNTAS PARA VÁLVULAS EGR
29	PEDAL DE ACELERADOR ELECTRÓNICO
30	REGULADORES DE PRESIÓN DE GASOLINA
37	RELEVADORES
38	REPUESTOS FUEL INJECTION
41	REPUESTOS PARA INYECTOR MULTIPORT
42	REPUESTOS PARA INYECTOR TBI
42	REPUESTOS PARA SENSOR DE PEDAL DE ACELERADOR
43	SENSORES DE PRESIÓN DE VAPOR DE COMBUSTIBLE
44	SENSORES DE DETONACIÓN
51	SENSORES DE FLUJO DE MASA DE AIRE (MAF)
57	SENSORES DE INFORMACIÓN DE PRESIÓN DE VÁLVULA EGR (PFE)
58	SENSORES DE POSICIÓN DEL ACELERADOR (TPS)
64	SENSORES DE POSICIÓN DEL ÁRBOL DE LEVAS (CMP)
75	SENSORES DE POSICIÓN DEL CIGÜEÑAL (CKP)
86	SENSORES DE POSICIÓN PARA LA VÁLVULA EGR (EVP)
87	SENSORES DE PRESIÓN ABSOLUTA DEL MÚLTIPLE (MAP)
95	SENSORES DE PRESIÓN DE RIEL DE INYECTORES
96	SENSORES DE TEMPERATURA DE CARGA DE AIRE (ACT,IAT, MAT)
101	SENSORES DE TEMPERATURA DEL MOTOR
102	SENSORES DE TEMPERATURA DEL REFRIGERANTE (CTS)
112	SENSORES DE VELOCIDAD (VSS)
119	SENSOR TPS PARA CUERPO DE ACELERACIÓN
119	SENSORES DE OXÍGENO
138	TUBO VÁLVULA EGR
138	VÁLVULAS AUXILIARES DE AIRE
138	VÁLVULAS DE CONTROL DE AIRE EN MARCHA MÍNIMA (IAC)
146	VÁLVULAS DE RECIRCULACIÓN DE GASES (EGR)
149	VÁLVULAS MAGNÉTICAS PARA DEPOSITO DE CARBÓN (AKF)
149	VÁLVULAS SOLENOIDE PARA SISTEMA EGR (EVP)



**PAG.**  
4 BULBOS PARA MOTOVENTILADOR  
4 AUDI  
4 CHRYSLER  
4 FORD  
5 GENERAL MOTORS  
5 NISSAN  
5 SEAT  
5 VOLKSWAGEN

7 CONECTORES PARA SENSORES

**CUERPOS DE ACELERACIÓN ELECTRÓNICOS**

8 CHRYSLER  
8 FORD  
8 GENERAL MOTORS  
9 MAZDA  
9 NISSAN  
9 RENAULT  
9 TOYOTA  
9 VOLKSWAGEN

**CUERPOS DE INYECTORES**

11 GENERAL MOTORS

**FILTROS PARA INYECTORES MULTIPORT**

12 CHRYSLER  
12 FORD  
12 GENERAL MOTORS  
12 VOLKSWAGEN

**INDICADORES DE TEMPERATURA DEL MOTOR**

13 CHRYSLER  
13 FORD  
13 GENERAL MOTORS  
14 HONDA  
14 MITSUBISHI  
14 NISSAN  
14 VOLKSWAGEN

**INYECTORES PARA SISTEMA MULTIPORT**

16 AUDI  
16 CHRYSLER  
17 FIAT  
17 FORD  
18 GENERAL MOTORS  
19 HONDA  
19 NISSAN  
20 PEUGEOT  
20 RENAULT  
20 SEAT  
20 TOYOTA  
20 VOLKSWAGEN

**INYECTORES PARA SISTEMA TBI**

28 CHRYSLER  
28 GENERAL MOTORS

**PAG. JUNTAS PARA VÁLVULA EGR**

29 AUDI  
29 GENERAL MOTORS  
29 NISSAN  
29 SEAT  
29 VOLKSWAGEN

**PEDALES DE ACELERADOR**

29 AUDI  
29 GENERAL MOTORS  
29 NISSAN  
29 SEAT  
29 VOLKSWAGEN

**REGULADORES DE PRESIÓN DE GASOLINA**

30 ACURA  
30 AUDI  
30 BMW  
30 CHRYSLER  
30 FORD  
31 GENERAL MOTORS  
32 HONDA  
32 MAZDA  
32 MITSUBISHI  
32 NISSAN  
32 RENAULT  
32 SEAT  
32 SUZUKI  
32 TOYOTA  
32 VOLKSWAGEN

**RELEVADORES DE VOLTAJE Y BOMBAS DE GASOLINA**

37 AUDI  
37 SEAT  
37 VOLKSWAGEN

**REPUESTOS FUEL INJECTION**

38 CHRYSLER  
38 FORD  
38 GENERAL MOTORS  
38 NISSAN  
38 RENAULT  
39 SEAT  
39 VOLKSWAGEN

41 REPUESTOS PARA INYECTORES MULTIPORT

42 REPUESTOS PARA INYECTOR TBI

**SENSORES DE PRESIÓN DE VAPOR DE COMBUSTIBLE**

43 FORD

**REPUESTO PARA SENSOR DE PEDAL DE ACELERADOR**

45 AUDI  
45 SEAT  
45 VOLKSWAGEN

**PAG. SENSORES DE DETONACIÓN (KS)**

46 ACURA  
46 AUDI  
47 CHRYSLER  
48 FIAT  
48 FORD  
49 GENERAL MOTORS  
51 HONDA  
51 MAZDA  
51 MERCEDES BENZ  
51 NISSAN  
51 PORSCHE  
51 RENAULT  
51 SEAT  
52 TOYOTA  
53 VOLKSWAGEN

**SENSORES DE FLUJO DE MASA DE AIRE (MAF)**

51 ACURA  
51 AUDI  
51 FORD  
52 GENERAL MOTORS  
53 HONDA  
53 JAGUAR  
53 LAND ROVER  
53 MAZDA  
53 MITSUBISHI  
53 NISSAN  
54 RENAULT  
54 TOYOTA  
54 VOLKSWAGEN  
54 VOLVO

**SENSORES DE INFORMACIÓN DE PRESIÓN DE VÁLVULA EGR (PFE)**

57 FORD

**SENSORES DE POSICIÓN DEL ACELERADOR (TPS)**

58 CHRYSLER  
59 FIAT  
59 FORD  
60 GENERAL MOTORS  
61 MITSUBISHI  
61 NISSAN  
61 PEUGEOT  
61 RENAULT  
61 TOYOTA  
61 VOLKSWAGEN

**SENSORES DE POSICIÓN DEL ÁRBOL DE LEVAS (CMP)**

64 ACURA  
64 AUDI  
65 BMW  
65 CHRYSLER  
66 FIAT  
66 FORD  
67 GENERAL MOTORS  
68 HONDA  
68 MAZDA  
68 MERCEDES BENZ  
68 MINI  
68 MITSUBISHI  
69 NISSAN



**SENSORES DE POSICIÓN DEL ÁRBOL DE LEVAS (CMP)**

PAG.	
69	PORSCHE
69	RENAULT
69	SEAT
69	SUZUKI
69	TOYOTA
69	VOLKSWAGEN

**SENSORES DE POSICIÓN DEL CIGÜEÑAL (CKP)**

75	ACURA
75	AUDI
75	BMW
75	CHRYSLER
76	FIAT
76	FORD
77	GENERAL MOTORS
79	HONDA
79	MAZDA
79	MERCEDES BENZ
79	MINI
79	NISSAN
80	PEUGEOT
80	RENAULT
80	SEAT
80	SUZUKI
80	TOYOTA
80	VOLKSWAGEN

**SENSORES DE POSICIÓN PARA LA VÁLVULA EGR (EVP)**

86	FORD
----	------

**SENSORES DE PRESIÓN ABSOLUTA DEL MÚLTIPLE (MAP)**

87	ACURA
87	AUDI
87	BMW
87	CHRYSLER
89	FIAT
89	FORD
89	GENERAL MOTORS
91	HONDA
91	LAND ROVER
91	MAZDA
91	MINI
91	NISSAN
91	PEUGEOT
91	RENAULT
91	SAAB
91	SEAT
91	VOLKSWAGEN

**SENSORES DE PRESIÓN DE RIEL DE INYECTORES**

95	FORD
----	------

**SENSORES DE TEMPERATURA DE CARGA DE AIRE (ACT,IAT, MAT)**

96	ACURA
96	AUDI
96	CHRYSLER
97	FIAT
97	FORD

**SENSORES DE TEMPERATURA DE CARGA DE AIRE (ACT,IAT, MAT)**

98	GENERAL MOTORS
98	HONDA
98	NISSAN
99	PEUGEOT
99	RENAULT
99	SEAT
99	VOLKSWAGEN

**SENSORES DE TEMPERATURA DEL MOTOR**

101	FORD
101	GENERAL MOTORS
101	VOLKSWAGEN

**SENSORES DE TEMPERATURA DEL REFRIGERANTE (CTS)**

102	ACURA
102	AUDI
103	CHRYSLER
104	FIAT
104	FORD
105	GENERAL MOTORS
106	HONDA
107	JAGUAR
107	MAZDA
107	MINI
107	NISSAN
108	PEUGEOT
108	PORSCHE
108	RENAULT
108	SAAB
108	SEAT
108	SUBARU
108	TOYOTA
108	VOLKSWAGEN

**SENSORES DE VELOCIDAD (VSS)**

112	ACURA
112	AUDI
112	CHRYSLER
113	FORD
114	GENERAL MOTORS
115	HONDA
115	LAND ROVER
115	MINI
115	NISSAN
115	PEUGEOT
115	RENAULT
115	TOYOTA
115	VOLKSWAGEN

**SENSOR TPS PARA CUERPO DE ACELERACIÓN**

119	AUDI
119	SEAT
119	VOLKSWAGEN

**SENSORES DE OXÍGENO**

119	ACURA
119	AUDI
119	BMW
119	CHRYSLER
121	FIAT
122	FORD
124	GENERAL MOTORS

**SENSORES DE OXÍGENO**

PAG.	
126	HONDA
126	MAZDA
126	MERCEDES BENZ
127	MINI
127	MITSUBISHI
127	NISSAN
128	PEUGEOT
128	RENAULT
128	SEAT
128	TOYOTA
128	VOLKSWAGEN

**TUBO VÁLVULA EGR**

138	NISSAN
-----	--------

**VÁLVULA AUXILIAR DE AIRE**

138	NISSAN
-----	--------

**VÁLVULAS DE CONTROL DE AIRE EN MARCHA MÍNIMA (IAC)**

138	CHRYSLER
139	FORD
139	GENERAL MOTORS
141	HONDA
141	NISSAN
141	PEUGEOT
141	RENAULT
141	TOYOTA
141	VOLKSWAGEN

**VÁLVULAS DE RECIRCULACIÓN DE GASES (EGR)**

146	CHRYSLER
146	FORD
146	GENERAL MOTORS
146	NISSAN

**VÁLVULAS MAGNÉTICAS PARA DEPOSITO DE CARBÓN (AKF)**

148	VOLKSWAGEN
-----	------------

**VÁLVULAS SOLENOIDE PARA SISTEMA EGR (EVP)**

148	FORD
-----	------

**BULBOS DE MOTOVENTILADOR**
**SU FUNCIÓN:**

Controla el circuito del motoventilador para encenderlo o apagarlo dentro de un rango de temperatura específico.

**SÍNTOMAS DE FALLA:**

El motoventilador no enciende a la temperatura de operación, o no se apaga.

**MANTENIMIENTO/SERVICIO:**

Mantener limpias las terminales del conector.

Revisar fugas de anticongelante.

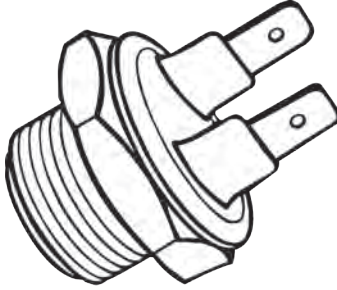

AUDI						
MODELO	AÑO	CIL.	MOTOR	SISTEMA	No. PARTE	
A4 (TEMP 75-82°C) 3 TERMINALES	02-02	6	3.0		73219	MPFI
A4 (TEMP 85-95°C) 3 TERMINALES	02-02	6	3.0		73219A	
A4 (TEMP 95-102°C) 3 TERMINALES	02-02	6	3.0		73219B	
A4 QUATTRO (TEMP 75-82°C) 3 TERMINALES	02-02	6	3.0		73219	
A4 QUATTRO (TEMP 85-95°C) 3 TERMINALES	02-02	6	3.0		73219A	
A4 QUATTRO (TEMP 95-102°C) 3 TERMINALES	02-02	6	3.0		73219B	
A4 QUATTRO TURBO (TEMP 75-82°C) 3 TERMINALES	98-02	4	1.8		73219	
A4 QUATTRO TURBO (TEMP 85-95°C) 3 TERMINALES	98-02	4	1.8		73219A	
A4 QUATTRO TURBO (TEMP 95-102°C) 3 TERMINALES	98-02	4	1.8		73219B	
A4 QUATTRO VR6 (TEMP 75-82°C) 3 TERMINALES	98-01	6	2.8		73219	
A4 QUATTRO VR6 (TEMP 85-95°C) 3 TERMINALES	98-01	6	2.8		73219A	
A4 QUATTRO VR6 (TEMP 95-102°C) 3 TERMINALES	98-01	6	2.8		73219B	
A4 TURBO (TEMP 75-82°C) 3 TERMINALES	97-02	4	3.0		73219	
A4 TURBO (TEMP 85-95°C) 3 TERMINALES	97-02	4	3.0		73219A	
A4 TURBO (TEMP 95-102°C) 3 TERMINALES	97-02	4	3.0		73219B	
A4 VR6 (TEMP 75-82°C) 3 TERMINALES	97-01	6	3.0		73219	
A4 VR6 (TEMP 85-95°C) 3 TERMINALES	97-01	6	3.0		73219A	
A4 VR6 (TEMP 95-102°C) 3 TERMINALES	97-01	6	3.0		73219B	

CHRYSLER						
MODELO	AÑO	CIL.	MOTOR	SISTEMA	No. PARTE	
LEBARON K	86-86	4	2.2	MPFI	73105	
VOLARE K	86-88	4	2.2	CARBURADO	73105	

CHRYSLER DODGE						
MODELO	AÑO	CIL.	MOTOR	SISTEMA	No. PARTE	
DART E	89-89	4	2.2	CARBURADO	73105	
DART K	86-89	4	2.2	CARBURADO	73105	

FORD						
MODELO	AÑO	CIL.	MOTOR	SISTEMA	No. PARTE	
AEROSTAR	91-95	6	3.0		73373	MPFI
AEROSTAR	91-95	6	4.0		73373	
ECONOLINE E-150	95-96	6	4.9		73373	
ESCORT	94-94	4	1.9		73373	
EXPLORER	91-96	6	4.0		73373	
EXPLORER	96-96	8	5.0		73373	
F-250	92-97	8	5.0		73373	
F-250	88-97	8	5.8		73373	
F-350	92-97	8	5.8		73373	
MUSTANG	94-95	8	5.0		73373	
MUSTANG	96-97	8	4.6		73373	
RANGER	96-96	6	3.0		73373	
TAURUS	88-91	6	3.8		73373	
THUNDERBIRD	85-91	6	3.8		73373	
THUNDERBIRD	94-96	8	4.6		73373	
THUNDERBIRD	91-93	8	5.0		73373	
WINDSTAR	95-96	6	3.8		73373	

FORD LINCOLN						
MODELO	AÑO	CIL.	MOTOR	SISTEMA	No. PARTE	
TOWN CAR	91-95	8	4.6	MPFI	73373	

FORD MERCURY						
MODELO	AÑO	CIL.	MOTOR	SISTEMA	No. PARTE	
COUGAR XR7	90-95	6	3.8		73373	MPFI
GRAND MARQUIS	81-84	8	5.0		73373	
GRAND MARQUIS	92-95	8	4.6		73373	
SABLE	94-95	6	3.8		73373	
TOPAZ	84-91	4	2.3		73373	

GENERAL MOTORS CHEVROLET						
MODELO	AÑO	CIL.	MOTOR	SISTEMA	No. PARTE	
CHEVY	96-00	4	1.6	TBI	73300	
CHEVY	96-00	4	1.6	MPFI	73300	
CHEVY	96-00	4	1.4	TBI	73300	
CHEVY	94-95	4	1.4	MPFI	73300	
CHEVY MONZA	96-00	4	1.6	MPFI	73300	
CHEVY MONZA	96-00	4	1.6	TBI	73300	

NISSAN						
MODELO	AÑO	CIL.	MOTOR	SISTEMA	No. PARTE	
TSURU I	84-87	4	1.6	CARBURADO	73067	
TSURU II	88-92	4	1.6		73067	

SEAT						
MODELO	AÑO	CIL.	MOTOR	SISTEMA	No. PARTE	
CORDOBA	01-02	4	1.6		73304	MPFI
CORDOBA	01-02	4	2.0		73304	
IBIZA	01-02	4	1.6		73304	

VOLKSWAGEN						
MODELO	AÑO	CIL.	MOTOR	SISTEMA	No. PARTE	
ATLANTIC (TEMP 70-75°C) 2 TERMINALES	84-87	4	1.7	CARBURADO	78239	MPFI
BEETLE (TEMP 90-97°C) 3 TERMINALES (CONECTOR AZUL)	99-02	4	2.0		73304	
BEETLE TURBO (TEMP 90-97°C) 3 TERMINALES (CONECTOR AZUL)	99-02	4	1.8		73304	
CARIBE (TEMP 70-75°C) 2 TERMINALES	84-87	4	1.7	CARBURADO	78239	MPFI
DERBY (TEMP 90-97°C) 2 TERMINALES	95-97	4	1.8		73079	
GOLF A2 (TEMP 70-75°C) 2 TERMINALES	88-92	4	1.8		73079	CARBURADO
GOLF A2 (TEMP 70-75°C) 2 TERMINALES	89-92	4	1.8		78239	
GOLF A2 (TEMP 75-82°C) 3 TERMINALES	87-92	4	1.8	MPFI	73219	

CONTINÚA»

VOLKSWAGEN						
MODELO	AÑO	CIL.	MOTOR	SISTEMA	No. PARTE	
GOLF A2 (TEMP 75-82°C) 3 TERMINALES	90-92	4	2.0	MPFI	73219	
GOLF A2 (TEMP 85-95°C) 3 TERMINALES	87-92	4	1.8		73219A	
GOLF A2 (TEMP 85-95°C) 3 TERMINALES	90-92	4	2.0		73219A	
GOLF A2 (TEMP 90-97°C) 3 TERMINALES (CONECTOR AZUL)	88-88	4	1.8	CARBURADO	73304	
GOLF A2 (TEMP 95-102°C) 3 TERMINALES	87-92	4	1.8		73219B	
GOLF A2 (TEMP 95-102°C) 3 TERMINALES	90-92	4	2.0		73219B	
GOLF A3 (TEMP 70-75°C) 2 TERMINALES	93-97	6	1.8		78239	
GOLF A3 (TEMP 75-82°C) 3 TERMINALES	93-97	6	1.8		73219	
GOLF A3 (TEMP 75-82°C) 3 TERMINALES	93-94	6	2.0		73219	
GOLF A3 (TEMP 85-95°C) 3 TERMINALES	93-97	6	1.8	MPFI	73219A	
GOLF A3 (TEMP 85-95°C) 3 TERMINALES	93-94	4	2.0		73219A	
GOLF A3 (TEMP 95-102°C) 3 TERMINALES	93-97	4	1.8		73219B	
GOLF A3 (TEMP 95-102°C) 3 TERMINALES	93-94	4	2.0		73219B	
GOLF A4 (TEMP 90-97°C) 3 TERMINALES (CONECTOR AZUL)	00-02	4	2.0		73304	
GOLF A4 GTI (TEMP 90-97°C) 3 TERMINALES (CONECTOR AZUL)	00-02	4	1.8		73304	
JETTA A2 (TEMP 70-75°C) 2 TERMINALES	88-92	4	1.8	CARBURADO	73079	
JETTA A2 (TEMP 70-75°C) 2 TERMINALES	88-92	4	1.8		78239	
JETTA A2 (TEMP 75-82°C) 3 TERMINALES	87-92	4	1.8	MPFI	73219	
JETTA A2 (TEMP 85-95°C) 3 TERMINALES	87-92	4	1.8		73219A	
JETTA A2 (TEMP 90-97°C) 3 TERMINALES (CONECTOR AZUL)	88-88	4	1.8	CARBURADO	73304	
JETTA A2 (TEMP 90-97°C) 3 TERMINALES (CONECTOR AZUL)	88-88	4	2.0		73304	
JETTA A2 (TEMP 95-102°C) 3 TERMINALES	87-92	4	1.8	MPFI	73219B	
JETTA A3 (TEMP 70-75°C) 2 TERMINALES	93-97	4	1.8		78239	
JETTA A3 (TEMP 75-82°C) 3 TERMINALES	93-97	4	1.8	MPFI	73219	
JETTA A3 (TEMP 85-95°C) 3 TERMINALES	93-97	4	1.8		73219A	
JETTA A3 (TEMP 95-102°C) 3 TERMINALES	93-97	4	1.8	CARBURADO	73219B	
JETTA A4 (TEMP 90-97°C) 3 TERMINALES (CONECTOR AZUL)	99-01	4	2.0		73304	
JETTA A4 TURBO (TEMP 90-97°C) 3 TERMINALES (CONECTOR AZUL)	99-01	4	1.8		73304	
PASSAT (TEMP 75-82°C) 3 TERMINALES	90-92	4	2.0		73219	
PASSAT (TEMP 85-95°C) 3 TERMINALES	93-97	4	2.0		73219A	
PASSAT (TEMP 95-102°C) 3 TERMINALES	93-97	4	2.0		73219B	
PASSAT TURBO (TEMP 75-82°C) 3 TERMINALES	93-94	4	1.8		73219	
PASSAT TURBO (TEMP 85-95°C) 3 TERMINALES	93-97	6	1.8	MPFI	73219A	
PASSAT TURBO (TEMP 95-102°C) 3 TERMINALES	93-94	4	1.8		73219B	
PASSAT VR6 (TEMP 75-82°C) 3 TERMINALES	93-97	6	2.8		73219	
PASSAT VR6 (TEMP 85-95°C) 3 TERMINALES	93-94	6	2.8		73219A	
PASSAT VR6 (TEMP 90-97°C) 3 TERMINALES (CONECTOR AZUL)	00-02	6	2.8		73304	
PASSAT VR6 (TEMP 95-102°C) 3 TERMINALES	00-02	6	2.8		73219B	
POINTER (TEMP 81-92°C) 2 TERMINALES	98-03	4	1.8		73302	
POINTER (TEMP 95-100°C) 3 TERMINALES	98-03	4	1.8		73303	

VOLKSWAGEN						
MODELO	AÑO	CIL.	MOTOR	SISTEMA	No. PARTE	
POINTER PICK UP (TEMP 81-92°C) 2 TERMINALES	99-03	4	1.8	MPFI	73302	
POINTER PICK UP (TEMP 95-100°C) 3 TERMINALES	99-03	4	1.8		73303	
POINTER WAGON (TEMP 81-92°C) 2 TERMINALES	99-03	4	1.8		73302	
POINTER WAGON (TEMP 95-100°C) 3 TERMINALES	99-03	4	1.8		73303	



**BULBOS DE MOTOVENTILADOR**

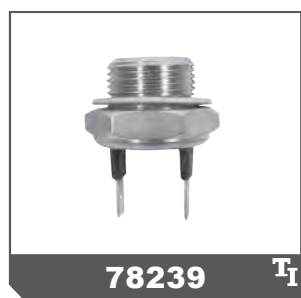
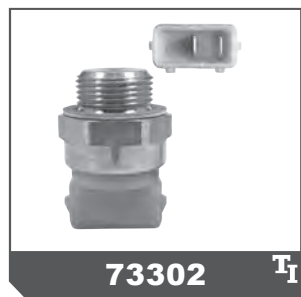
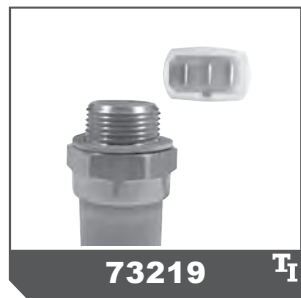

NUMERO DE CONECTOR	DESCRIPCION:	COMPATIBLE CON:
24011	CONECTOR SENSOR MAP	18000
24013	CONECTOR SENSOR MAF	20002-X
24014	CONECTOR SENSOR CKP / CTS	12001, 12014, 22102, 22114
24019	CONECTOR SENSOR ACT	12101, 12111, 12116, 12118
24021	CONECTOR VÁLVULA IAC	8405, 8406, 8417, 8420, 8430, 8442, 8443, 8448, 8449, 8452, 8454, 8456, 8458, 8459, 8461, 8466, 8468, 8469, 8470, 8485, 84957, 84973, 84991, 84993, 84994, 84996

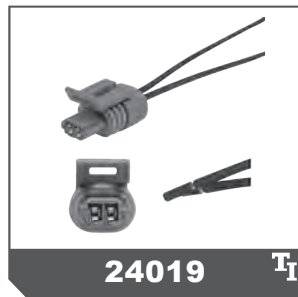
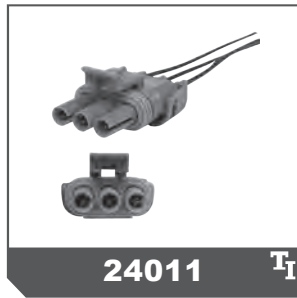

**CUERPOS DE ACELERACIÓN ELECTRÓNICOS**
**SU FUNCIÓN:**

Regulan la entrada de aire al motor tanto en ciclos de aceleración / desaceleración, como en marcha mínima.

**SÍNTOMAS DE FALLA:**

Marcha mínima inestable, aceleraciones / desaceleraciones descontroladas.

**MANTENIMIENTO/SERVICIO:**

Diagnosticar con escanner (por fabricante), y dar servicio. Limpiar "únicamente" con líquido dieléctrico.

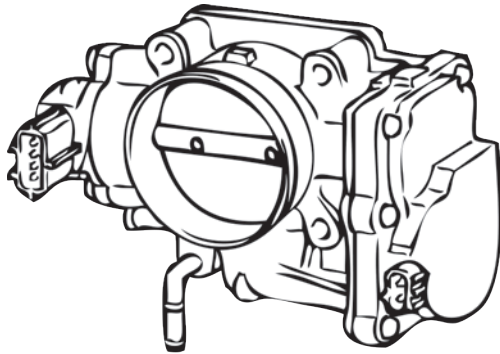

CHRYSLER					
MODELO	AÑO	CIL.	MOTOR	SISTEMA	No. PARTE
200	12-16	6	3.6	MPFI	6311
200 <b>NUEVO</b>	12-17	6	2.4		6311
300 <b>NUEVO</b>	12-14	4	3.6		6335
PACIFICA	17-17	6	3.6		6311
TOWN & COUNTRY	11-16	6	3.6		6311

CHRYSLER			DODGE		
MODELO	AÑO	CIL.	MOTOR	SISTEMA	No. PARTE
ATTITUDE <b>NUEVO</b>	12-14	4	1.4	MPFI	6334
AVENGER <b>NUEVO</b>	08-10	4	2.0		6335
AVENGER <b>NUEVO</b>	08-14	4	2.4		6335
CALIBER <b>NUEVO</b>	07-07	4	1.8		6335
CALIBER <b>NUEVO</b>	07-07	4	2.0		6335
CALIBER <b>NUEVO</b>	07-12	4	2.4		6335
CHALLENGER	13-17	6	3.6		6311
CHARGER	11-13	6	3.6		6311
DURANGO	12-15	6	3.6		6311
GRAND CARAVAN	17-17	6	3.6		6311
JOURNEY <b>NUEVO</b>	09-17	4	2.4		6335
JOURNEY R/T	11-17	6	3.6		6311
PROMASTER 1500	14-17	6	3.6		6311
PROMASTER 2500	14-17	6	3.6	6311	
PROMASTER 3500	14-17	6	3.6	6311	
RAM 1500	14-17	6	3.6	6311	

CHRYSLER			JEEP		
MODELO	AÑO	CIL.	MOTOR	SISTEMA	No. PARTE
CHEROKEE	14-17	6	3.2	MPFI	6311
COMPASS <b>NUEVO</b>	07-17	4	2.4		6335
GRAND CHEROKEE	11-17	6	3.6		6311
PATRIOT <b>NUEVO</b>	07-16	4	2.4		6335
WRANGLER	12-17	6	3.6		6311

FORD					
MODELO	AÑO	CIL.	MOTOR	SISTEMA	No. PARTE
ESCAPE <b>NUEVO</b>	09-12	4	2.5	MPFI	6332
ESCAPE <b>NUEVO</b>	09-12	6	3.0		6332
ESCAPE TURBO <b>NUEVO</b>	14-14	4	2.0		6325
EXPEDITION	05-14	8	5.4		6209
F-350 SUPER DUTY	04-10	8	5.4		6209
FIESTA <b>NUEVO</b>	11-17	4	1.6		6328
FOCUS ST TURBO <b>NUEVO</b>	13-14	4	2.0	6325	

FORD					
MODELO	AÑO	CIL.	MOTOR	SISTEMA	No. PARTE
FUSION TURBO <b>NUEVO</b>	13-15	4	2.0	MPFI	6325
FUSION <b>NUEVO</b>	10-16	4	2.5		6332
FUSION <b>NUEVO</b>	10-12	6	3.0		6332
RANGER <b>NUEVO</b>	13-17	4	2.5		6332

FORD			LINCOLN		
MODELO	AÑO	CIL.	MOTOR	SISTEMA	No. PARTE
MARK LT	06-08	8	5.4	MPFI	6209
MKZ TURBO <b>NUEVO</b>	13-16	4	2.0		6325
NAVIGATOR	06-14	8	5.4		6209

FORD			MERCURY		
MODELO	AÑO	CIL.	MOTOR	SISTEMA	No. PARTE
MARINER <b>NUEVO</b>	09-11	6	3.0	MPFI	6332

GENERAL MOTORS			CADILLAC		
MODELO	AÑO	CIL.	MOTOR	SISTEMA	No. PARTE
ESCALADE	03-06	8	6.0	MPFI	6312
ESCALADE	07-08	8	6.2		6315
ESCALADE ESV	07-08	8	6.2		6315
ESCALADE EXT	07-08	8	6.2		6315

GENERAL MOTORS			CHEVROLET		
MODELO	AÑO	CIL.	MOTOR	SISTEMA	No. PARTE
AVALANCHE	03-06	8	5.3	MPFI	6312
AVALANCHE	07-08	8	5.3		6315
AVEO (MECÁNICO)	08-17	4	1.6		6322
CAPTIVA SPORT	08-08	6	3.6		6320
CRUZE <b>NUEVO</b>	10-15	4	1.8		6326
EQUINOX	07-08	6	3.4		6320
EXPRESS 1500	07-07	8	5.3		6312
EXPRESS 1500	08-08	8	5.3		6315
EXPRESS 3500	04-07	8	6.0		6312
EXPRESS 3500	08-08	8	6.0		6315
MALIBU	07-07	6	3.5		6320
MALIBU	08-12	6	3.6		6321
SILVERADO 1500	07-12	6	4.3		6321
SILVERADO 2500	03-07	8	5.3		6312
SILVERADO 3500	03-06	8	6.0		6312
SILVERADO 3500 HD	08-15	8	6.0		6315
SONIC	12-17	4	1.6		6313
SUBURBAN 1500	03-06	8	5.3	6312	
SUBURBAN 1500	07-08	8	5.3	6315	
SUBURBAN 2500	03-06	8	6.0	6312	
SUBURBAN 2500	07-08	8	6.0	6315	
TAHOE	07-08	8	5.3	6315	
TORNADO <b>NUEVO</b>	11-16	4	1.8	6333	
TRAIL BLAZER	06-06	8	5.3	6315	
TRAIL BLAZER EXT	03-04	8	5.3	6312	
TRAIL BLAZER EXT	05-06	8	5.3	6315	
UPLANDER	07-09	6	3.9	6320	

GENERAL MOTORS			GMC		
MODELO	AÑO	CIL.	MOTOR	SISTEMA	No. PARTE
YUKON	07-08	8	5.3	MPFI	6315

GENERAL MOTORS			HUMMER		
MODELO	AÑO	CIL.	MOTOR	SISTEMA	No. PARTE
H2	05-07	8	6.0	MPFI	6312
H3	08-08	8	5.3		6315

GENERAL MOTORS			PONTIAC		
MODELO	AÑO	CIL.	MOTOR	SISTEMA	No. PARTE
G6	07-09	6	3.6	MPFI	6321
MONTANA	06-09	6	3.9		6320
TORRENT	07-09	6	3.4		6320

CONTINÚA»



# CUERPOS DE ACELERACIÓN ELECTRÓNICOS

MAZDA						
MODELO	AÑO	CIL.	MOTOR	SISTEMA	No. PARTE	
3	06-13	4	2.0	MPFI	6210	
3	06-09	4	2.3		6210	
5	08-10	4	2.3		6210	
6	06-08	4	2.3		6210	
2	<b>NUEVO</b> 12-15	4	1.5		6324	
3 SPEED TURBO	08-13	4	2.3		6210	
CX-7	10-12	4	2.5		6210	
CX-7 TURBO	07-12	4	2.3	6210		



NISSAN			INFINITI			
MODELO	AÑO	CIL.	MOTOR	SISTEMA	No. PARTE	
I35	03-03	6	3.5	MPFI	6318	

NISSAN						
MODELO	AÑO	CIL.	MOTOR	SISTEMA	No. PARTE	
350Z	03-06	6	3.5	MPFI	6318	
ALTIMA	07-16	4	2.5		6314	
ALTIMA	02-06	4	2.5		6317	
ALTIMA	02-06	6	3.5		6318	
ALTIMA	07-16	6	3.5		6319	
MAXIMA	03-08	6	3.5		6318	
MURANO	04-07	6	3.5		6318	
MURANO	09-14	6	3.5		6319	
QUEST	04-09	6	3.5		6318	
ROGUE	08-14	4	2.5		6314	
SENTRA	03-06	4	1.8		6316	
SENTRA SE-R	07-12	4	2.5		6314	
SENTRA SE-R	02-06	4	2.5		6317	
URVAN	08-13	4	2.5		6314	
X-TRAIL	07-08	4	2.5		6314	
X-TRAIL	02-06	4	2.5	6317		



RENAULT						
MODELO	AÑO	CIL.	MOTOR	SISTEMA	No. PARTE	
KOLEOS	09-11	4	2.5	MPFI	6314	



TOYOTA						
MODELO	AÑO	CIL.	MOTOR	SISTEMA	No. PARTE	
HIACE	<b>NUEVO</b> 06-16	4	2.7	MPFI	6330	
YARIS	<b>NUEVO</b> 06-17	4	1.5		6327	



VOLKSWAGEN						
MODELO	AÑO	CIL.	MOTOR	SISTEMA	No. PARTE	
BEETLE	01-03	4	2.0	MPFI	6323	
BEETLE	<b>NUEVO</b> 06-16	5	2.5		6331	
BORA	<b>NUEVO</b> 06-10	5	2.5		6331	
GOLF A4	01-03	4	2.0		6323	
GOLF A5 SPORT WAGEN	<b>NUEVO</b> 10-13	5	2.5		6331	
JETTA A4	01-05	4	2.0		6323	
JETTA A6	<b>NUEVO</b> 11-16	5	2.5		6331	
PASSAT	<b>NUEVO</b> 12-16	5	2.5		6331	
VENTO	<b>NUEVO</b> 14-17	4	1.6		6329	



**CUERPOS DE ACELERACIÓN ELECTRÓNICOS**



**6319** <sup>TI</sup>



**6320** <sup>TI</sup>



**6321** <sup>TI</sup>



**6322** <sup>TI</sup>  
NUEVO



**6323** <sup>TI</sup>  
NUEVO



**6324** <sup>TI</sup>  
NUEVO



**6325** <sup>TI</sup>  
NUEVO



**6326** <sup>TI</sup>  
NUEVO



**6327** <sup>TI</sup>  
NUEVO



**6328** <sup>TI</sup>  
NUEVO



**6329** <sup>TI</sup>  
NUEVO



**6330** <sup>TI</sup>  
NUEVO



**6331** <sup>TI</sup>  
NUEVO



**6332** <sup>TI</sup>  
NUEVO



**6333** <sup>TI</sup>  
NUEVO



**6334** <sup>TI</sup>  
NUEVO



**6335** <sup>TI</sup>  
NUEVO

**SU FUNCIÓN:**

Distribuyen el flujo de combustible a cada cilindro del motor.

**SÍNTOMAS DE FALLA:**

Cascabeleo del motor, pérdida de potencia, humo negro.

**MANTENIMIENTO/SERVICIO:**

Lavar e inspeccionar cada 60,000 km.

GENERAL MOTORS		CHEVROLET			
MODELO	AÑO	CIL.	MOTOR	SISTEMA	No. PARTE
C2500	96-00	8	5.7	MPFI	15855
C2500	96-98	8	5.0		15855
C3500	96-00	8	5.7		15855
EXPRESS 3500	96-02	8	5.7		15855
SONORA	00-02	8	5.7		15855
P30	96-99	8	5.7		15855
SILVERADO 1500	99-06	6	4.3		15856
BLAZER	96-01	6	4.3		15856
EXPRESS 1500	96-06	6	4.3		15856

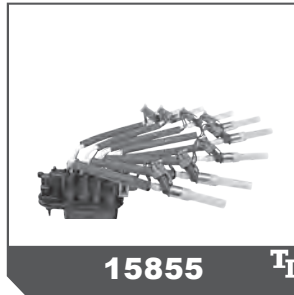

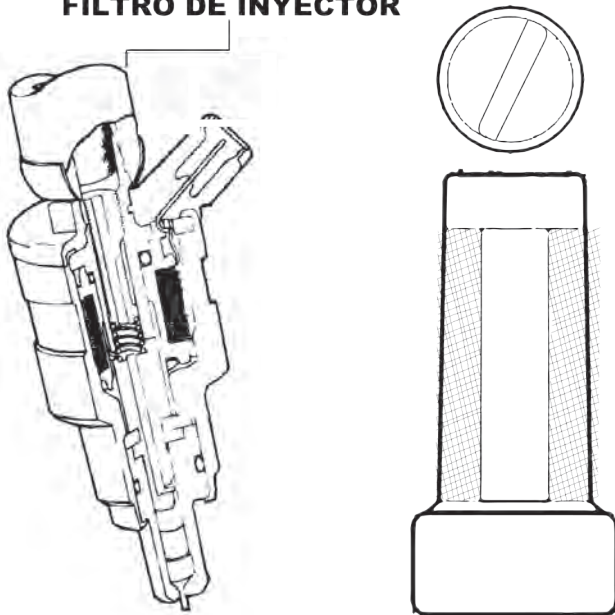

**FILTRO INTERIOR PARA INYECTOR MULTIPOINT**
**FILTRO DE INYECTOR**

CHRYSLER					
MODELO	AÑO	CIL.	MOTOR	SISTEMA	No. PARTE
LEBARON K	84-87	4	2.2	MPFI	27100
LEBARON K	84-87	4	2.2		27101
LEBARON TURBO	92-94	4	2.5		27100
LEBARON TURBO	92-94	4	2.5		27101
NEW YORKER K	85-88	4	2.2		27100
NEW YORKER K	85-88	4	2.2		27101
NEW YORKER TURBO	91-94	4	2.5		27100
NEW YORKER TURBO	91-94	4	2.5		27101
PHANTOM TURBO	87-88	4	2.2		27100
PHANTOM TURBO	87-88	4	2.2		27101

CHRYSLER		DODGE			
MODELO	AÑO	CIL.	MOTOR	SISTEMA	No. PARTE
MAGNUM K	84-88	4	2.2	MPFI	27100
MAGNUM K	84-88	4	2.2		27101
SHADOW	91-95	4	2.5		27100
SHADOW	91-95	4	2.5		27101
SHADOW GTS	89-90	4	2.2		27100
SHADOW GTS	89-90	4	2.2		27101
SPIRIT	91-95	4	2.5		27100
SPIRIT	91-95	4	2.5		27101

FORD					
MODELO	AÑO	CIL.	MOTOR	SISTEMA	No. PARTE
AEROSTAR	91-95	6	3.0	MPFI	27100
AEROSTAR	91-95	6	3.0		27101
ECONOLINE E-150	95-96	6	4.9		27100
ECONOLINE E-150	95-96	6	4.9		27101
ESCORT	94-96	4	1.9		27100
ESCORT	94-96	4	1.9		27101
F-150	95-96	6	4.9		27100
F-150	95-96	6	4.9		27101
GHIA	91-91	4	2.3		27100
GHIA	93-94	6	3.0		27100
GHIA	91-91	4	2.3		27101
GHIA	93-94	6	3.0		27101
TAURUS	88-91	6	3.8		27100
TAURUS	88-91	6	3.8		27101
THUNDERBIRD	89-96	6	3.8		27100
THUNDERBIRD	89-96	6	3.8		27101

FORD		MERCURY			
MODELO	AÑO	CIL.	MOTOR	SISTEMA	No. PARTE
COUGAR XR7	90-94	6	3.8	MPFI	27100
COUGAR XR7	90-94	6	3.8		27101
TOPAZ	89-94	4	2.3		27100
TOPAZ	89-94	4	2.3		27101

GENERAL MOTORS		BUICK			
MODELO	AÑO	CIL.	MOTOR	SISTEMA	No. PARTE
CENTURY	87-95	6	2.8	MPFI	27100
CENTURY	87-95	6	2.8		27101
REGAL	94-96	6	3.8		27100
REGAL	94-96	6	3.8		27101

GENERAL MOTORS		CHEVROLET			
MODELO	AÑO	CIL.	MOTOR	SISTEMA	No. PARTE
CAVALIER	90-94	6	2.8	MPFI	27100
CAVALIER	90-94	6	2.8		27101
CAVALIER Z24	91-94	6	3.1		27100
CAVALIER Z24	91-94	6	3.1		27101
CELEBRITY	87-89	6	2.8		27100
CELEBRITY	87-89	6	2.8		27101

GENERAL MOTORS		OLDSMOBILE			
MODELO	AÑO	CIL.	MOTOR	SISTEMA	No. PARTE
88	92-95	6	3.8	MPFI	27100
88	92-95	6	3.8		27101
CUTLASS	87-88	6	2.8		27100
CUTLASS	89-96	6	3.1		27100
CUTLASS	87-88	6	2.8		27101
CUTLASS	89-96	6	3.1		27101

GENERAL MOTORS		PONTIAC			
MODELO	AÑO	CIL.	MOTOR	SISTEMA	No. PARTE
BONNEVILLE	94-94	6	3.8	MPFI	27100
BONNEVILLE	94-94	6	3.8		27101

VOLKSWAGEN					
MODELO	AÑO	CIL.	MOTOR	SISTEMA	No. PARTE
COMBI	93-98	4	1.8	MPFI	27100
COMBI	93-98	4	1.8		27101
GOLF A3	93-98	4	1.8		27100
GOLF A3	93-98	4	2.0		27100
GOLF A3	93-98	4	1.8		27101
GOLF A3	93-98	4	2.0		27101
JETTA A3	93-99	4	1.8		27100
JETTA A3	93-99	4	2.0		27100
JETTA A3	93-99	4	1.8		27101
JETTA A3	93-99	4	2.0		27101

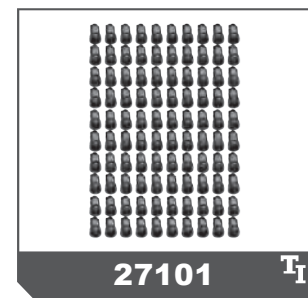

**SU FUNCIÓN:**

Indica la temperatura del motor hacia el tablero.

**SÍNTOMAS DE FALLA:**

El indicador no muestra la temperatura en el tablero o esta es incorrecta.

**MANTENIMIENTO/SERVICIO:**

Revisar periódicamente y limpiar la punta del indicador.

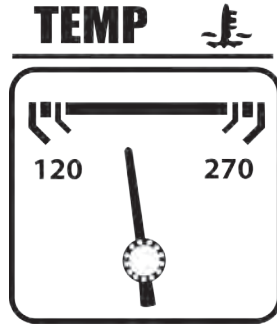

CHRYSLER					
MODELO	AÑO	CIL.	MOTOR	SISTEMA	No. PARTE
CONCORDE	94-94	6	3.5	MPFI	12827
LEBARON K	84-87	4	2.2		12827
LEBARON TURBO	92-94	4	2.5		12827
NEW YORKER K	84-88	4	2.2		12827
NEW YORKER LHS	94-94	6	3.5		12827
TOWN & COUNTRY	94-95	6	3.8		12827
TOWN & COUNTRY	93-93	6	3.3		12827
VOYAGER	94-95	6	3.3		12827

CHRYSLER			DODGE		
MODELO	AÑO	CIL.	MOTOR	SISTEMA	No. PARTE
NEON	95-95	4	2.0	MPFI	12827
RAM 1500	94-99	6	3.9		12810
RAM 2500	94-99	8	5.9		12810
RAM 3500	94-99	8	5.9		12810
SHADOW	91-94	4	2.5		12827
SHADOW GTS	89-90	4	2.2		12827
SPIRIT	91-95	4	2.5		12827

CHRYSLER			JEEP		
MODELO	AÑO	CIL.	MOTOR	SISTEMA	No. PARTE
CHEROKEE SPORT	94-94	6	4.0	MPFI	12811
CHEROKEE SPORT	94-94	6	4.0		12813
GRAND CHEROKEE	93-95	6	4.0		12811
GRAND CHEROKEE	93-95	8	5.2		12811
GRAND CHEROKEE	94-96	6	4.0		12813
WRANGLER	93-95	4	2.5		12811
WRANGLER	93-95	4	2.5		12813

FORD					
MODELO	AÑO	CIL.	MOTOR	SISTEMA	No. PARTE
AEROSTAR	91-95	6	3.0	MPFI	12815
AEROSTAR	91-95	6	4.0		12815
CONTOUR	99-00	4	2.0		12800
CONTOUR	95-00	6	2.5		12814
CONTOUR 2 TERMINALES	98-00	6	2.5		12802
CONTOUR CON ROSCA	98-99	4	2.0		12801
ECONOLINE E-150	97-03	6	4.2		12817
ECONOLINE E-150	04-08	8	4.6		12817
ECONOLINE E-250	97-03	6	4.2		12817
ECONOLINE E-250	99-04	8	5.4		12817
ECONOLINE E-350	97-03	8	5.4		12817
ESCORT	94-96	4	1.9		12815
ESCORT	97-01	4	2.0		12800

FORD					
MODELO	AÑO	CIL.	MOTOR	SISTEMA	No. PARTE
ESCORT	97-01	4	2.0	MPFI	12802
ESCORT CON ROSCA	98-01	4	2.0		12801
EXCURSION	01-03	10	6.8		12817
EXPEDITION	97-02	8	4.6		12817
EXPEDITION	97-02	8	5.4		12817
EXPLORER	02-03	6	4.0		12800
EXPLORER	91-96	6	4.0		12815
EXPLORER	97-03	6	4.0		12802
EXPLORER	02-03	8	4.6		12802
EXPLORER	97-01	8	5.0		12802
F-150	92-94	6	3.8		12815
F-150	97-03	6	4.2		12817
F-150	97-04	8	4.6		12817
F-150 RESISTENCIA SENSOR 357 ohms	94-96	6	4.9		12815
F-150	94-97	6	4.9		12826
F-150	97-97	6	4.9		12817
F-250	98-99	8	4.6		12817
F-250	92-97	8	5.0		12826
F-250	88-97	8	5.8		12826
F-350	95-97	8	5.0		12826
F-350	92-97	8	5.8		12826
F-350 SUPER DUTY	99-04	8	5.4		12817
F-450 SUPER DUTY	99-03	10	6.8		12817
F-550 SUPER DUTY	99-03	10	6.8		12817
LOBO	03-03	8	5.4		12817
MICROBUS	92-94	8	5.0		12815
MUSTANG	98-98	8	4.6		12802
RANGER	01-11	4	2.3		12802
RANGER	94-96	4	2.3		12815
RANGER	97-97	4	2.3		12802
RANGER	97-02	6	3.0		12802
THUNDERBIRD	88-89	6	3.8		12815
WINDSTAR	95-96	6	3.8	12815	
WINDSTAR	97-03	6	3.8	12802	

FORD			LINCOLN		
MODELO	AÑO	CIL.	MOTOR	SISTEMA	No. PARTE
NAVIGATOR	98-02	8	5.4	MPFI	12817
TOWN CAR	98-98	8	4.6		12802

FORD			MERCURY		
MODELO	AÑO	CIL.	MOTOR	SISTEMA	No. PARTE
GRAND MARQUIS	98-03	8	4.6	MPFI	12802
MYSTIQUE	99-00	4	2.0		12800
MYSTIQUE CON ROSCA	98-98	4	2.0		12801
MYSTIQUE	98-00	6	2.5		12802
MYSTIQUE 2 TERMINALES	95-00	6	2.5		12814
SABLE	97-02	6	3.0		12802

GENERAL MOTORS			BUICK		
MODELO	AÑO	CIL.	MOTOR	SISTEMA	No. PARTE
CENTURY	82-86	6	2.8	CARBURADO	12804

GENERAL MOTORS			CHEVROLET			
MODELO	AÑO	CIL.	MOTOR	SISTEMA	No. PARTE	
AVEO	08-17	4	1.6	MPFI	12803	
BLAZER	96-99	6	4.3		12816	
C2500	96-00	8	5.7		12816	
C2500	96-98	8	5.0		12816	
C3500	96-00	8	5.7		12816	
CAVALIER	90-94	6	2.8		12806	
CAVALIER Z24	91-94	6	3.1		12806	
CELEBRITY	83-86	6	2.8		CARBURADO	12804
CHEVY	96-03	4	1.6		TBI	12803
CHEVY	09-12	4	1.6		MPFI	12803
CHEVY	96-03	4	1.6	MPFI	12803	

CONTINÚA»

**INDICADORES DE TEMPERATURA DEL MOTOR**

GENERAL MOTORS		CHEVROLET				
MODELO	AÑO	CIL.	MOTOR	SISTEMA	No. PARTE	
CHEVY	96-03	4	1.4	TBI	12803	
CHEVY	94-95	4	1.4		12803	
CHEVY C2	04-08	4	1.6	MPFI	12803	
CHEVY MONZA	96-03	4	1.6		12803	
CHEVY MONZA	96-03	4	1.6	TBI	12803	
CHEVY MONZA	09-12	4	1.6		12803	
CHEVY PICK UP	99-03	4	1.6		12803	
CHEVY WAGON	00-03	4	1.6		12803	
EXPRESS 1500	96-02	6	4.3		12816	
EXPRESS 2500	96-02	8	5.7		12816	
EXPRESS 3500	96-02	8	5.7	MPFI	12816	
MATIZ	11-15	4	1.0		12803	
OPTRA	06-10	4	2.0		12803	
P30	96-99	8	5.7		12816	
SILVERADO 1500	99-01	6	4.3		12816	
TRACKER	98-98	4	1.6		12818	

GENERAL MOTORS		OLDSMOBILE				
MODELO	AÑO	CIL.	MOTOR	SISTEMA	No. PARTE	
CUTLASS	89-96	6	3.1	MPFI	12806	

GENERAL MOTORS		PONTIAC				
MODELO	AÑO	CIL.	MOTOR	SISTEMA	No. PARTE	
MATIZ	04-10	4	1.0	MPFI	12803	

HONDA						
MODELO	AÑO	CIL.	MOTOR	SISTEMA	No. PARTE	
ACCORD	98-01	4	2.3		12809	
ACCORD	98-01	6	3.0		12809	
ACCORD	96-97	4	2.2	MPFI	12809	
CIVIC	97-00	4	1.6		12809	
ODYSSEY	00-00	6	3.5		12809	

MITSUBISHI						
MODELO	AÑO	CIL.	MOTOR	SISTEMA	No. PARTE	
GALANT	03-03	6	3.0		12818	
LANCER	04-07	4	2.0		12818	
LANCER RALLIART	05-05	4	2.4	MPFI	12818	
MONTERO	04-06	6	3.8		12818	
MONTERO SPORT	03-04	6	3.5		12818	
OUTLANDER	04-06	4	2.4		12818	

NISSAN		INFINITI				
MODELO	AÑO	CIL.	MOTOR	SISTEMA	No. PARTE	
Q45	96-96	8	4.5	MPFI	12829	

NISSAN						
MODELO	AÑO	CIL.	MOTOR	SISTEMA	No. PARTE	
240SX	93-93	4	2.4		12829	
300ZX	91-96	6	3.0		12829	
ALTIMA	96-01	4	2.4		12807	
D21	97-08	4	2.4		12807	
D21	91-96	4	2.4	MPFI	12829	
SENTRA	00-01	4	2.0		12807	
SENTRA	92-92	4	1.6		12829	
TSURU II	88-92	4	1.6		12828	
TSURU III	95-16	4	1.6		12807	

VOLKSWAGEN						
MODELO	AÑO	CIL.	MOTOR	SISTEMA	No. PARTE	
POINTER	98-03	4	1.8		12808	
POINTER	04-09	4	1.8	MPFI	12830	
POINTER PICK UP	99-03	4	1.8		12808	

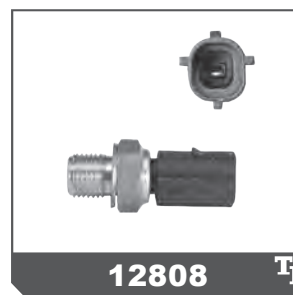
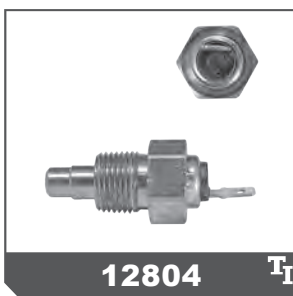
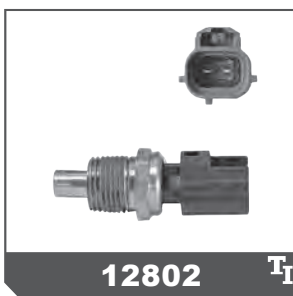
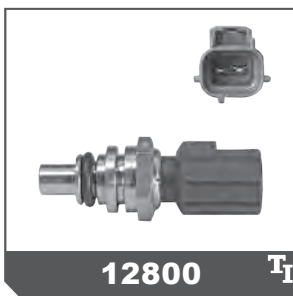

# INDICADORES DE TEMPERATURA DEL MOTOR

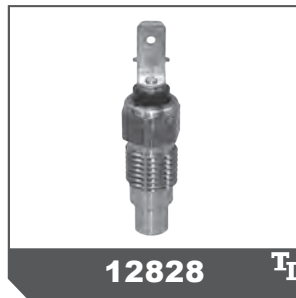
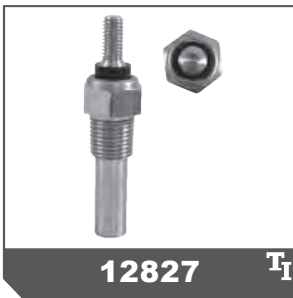
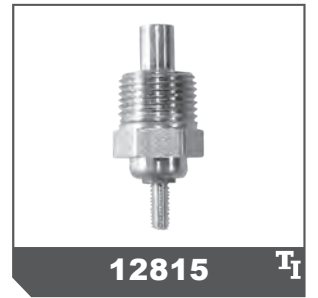
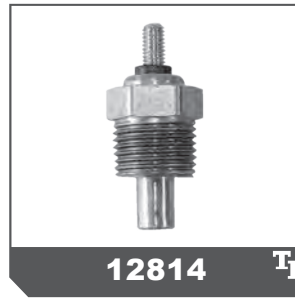

**SU FUNCIÓN:**

Medir y promover la gasolina del motor.

**SÍNTOMAS DE FALLA:**

El motor no responde, dificultad para arrancar, jaloneo, aumento de las emisiones contaminantes y poco rendimiento.

**MANTENIMIENTO/SERVICIO:**

Inspeccionar cada 40, 000 - 65, 000 kms. o cuando ocurran problemas en el motor.

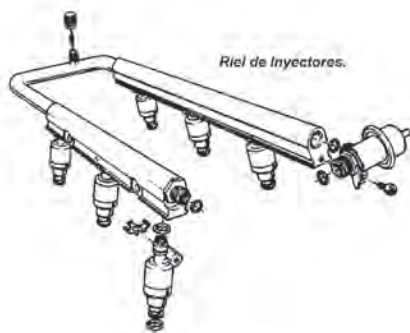

AUDI					
MODELO	AÑO	CIL.	MOTOR	SISTEMA	No. PARTE
A4	06-08	6	3.2	MPFI	15961
A4 QUATTRO	05-09	6	3.2		15961
A6	06-09	6	3.2		15961
S6	07-11	10	5.2		15961
S8	07-10	10	5.2		15961

CHRYSLER					
MODELO	AÑO	CIL.	MOTOR	SISTEMA	No. PARTE
200	12-16	6	3.6	MPFI	15908
300	12-17	6	3.6		15908
300	12-15	8	5.7		15952
300C	05-09	8	5.7		15853
300C	05-10	6	3.5		15932
300C	10-10	8	5.7		15952
300C SRT-8	06-08	8	6.1		15952
ASPEN	09-09	8	5.7		15952
CIRRUS	96-00	6	2.5		15873
CONCORDE	93-97	6	3.5		15655
GRAND VOYAGER	91-93	6	3.3		15652
GRAND VOYAGER	94-00	6	3.8		15652
GRAND VOYAGER	01-04	6	3.8		15844
LEBARON K TURBO	84-87	4	2.2		15512
LEBARON TURBO	92-94	4	2.5		15596
NEW YORKER K TURBO	85-88	4	2.2		15512
NEW YORKER LH	94-96	6	3.5		15655
NEW YORKER TURBO	91-94	4	2.5		15596
PACIFICA	07-07	6	3.8		15844
PACIFICA	05-06	6	3.5		15932
PACIFICA	07-08	6	4.0		15932
PHANTOM TURBO	87-88	4	2.2		15512
PT CRUISER	04-10	4	2.4		15889
PT CRUISER	01-03	4	2.4		15894
PT CRUISER TURBO	03-07	4	2.4		15951
TOWN & COUNTRY	93-93	6	3.3		15652
TOWN & COUNTRY	94-00	6	3.8		15652
TOWN & COUNTRY	03-07	6	3.8		15844
TOWN & COUNTRY	11-16	6	3.6		15908
TOWN & COUNTRY	08-10	6	4.0		15932
VOYAGER	94-95	6	3.3		15652
VOYAGER	01-03	6	3.3		15918
VOYAGER	96-00	6	3.3	15922	

MODELO	AÑO	CIL.	MOTOR	CHRYSLER		DODGE	
				SISTEMA	No. PARTE	SISTEMA	No. PARTE
ATOS	01-04	4	1.0	MPFI		15901	
ATOS	05-12	4	1.1		15901		
ATTITUDE	06-11	4	1.6		15839		
ATTITUDE	12-14	4	1.6		15962		
AVENGER	08-10	6	3.5		15932		
CALIBER SRT-4 TURBO	08-09	4	2.4		15951		
CHALLENGER	13-17	6	3.6		15908		
CHALLENGER R/T	09-14	8	5.7		15952		
CHALLENGER SRT-8	08-10	8	6.1		15952		
CHARGER	06-10	6	3.5		15932		
CHARGER	11-13	6	3.6		15908		
CHARGER R/T	06-09	8	5.7		15853		
CHARGER R/T	10-15	8	5.7		15952		
CHARGER SRT-8	07-10	8	6.1		15952		
DAKOTA	05-10	6	3.7		15954		
DAKOTA	11-11	6	3.7		15954		
DURANGO	12-15	6	3.6		15908		
DURANGO	00-00	8	4.7		15847		
DURANGO	08-09	8	4.7		15853		
DURANGO	98-99	8	5.2		15639		
DURANGO	12-15	8	5.7		15952		
DURANGO	98-99	8	5.9		15639		
DURANGO	00-03	8	5.9		15885		
GRAND CARAVAN	17-17	6	3.6		15908		
H100 CHASIS	03-05	4	2.4		15857		
H100 VAN	12-14	4	2.4		15944		
i10	12-14	4	1.1		15941		
INTREPID	94-97	6	3.5		15655		
JOURNEY R/T	09-10	6	3.5		15932		
JOURNEY R/T	11-17	6	3.6		15908		
MAGNUM K TURBO	84-88	4	2.2		15512		
NEON	04-05	4	2.0		15843		
NEON	01-03	4	2.0	15894			
NEON (SOHC/DOHC/TA)	95-96	4	2.0	15648			
NEON SRT-4 TURBO	04-05	4	2.4	15951			
NITRO	07-11	6	3.7	15954			
NITRO R/T	07-09	6	4.0	15932			
PROMASTER 1500	14-17	6	3.6	15908			
PROMASTER 2500	14-17	6	3.6	15908			
PROMASTER 3500	14-17	6	3.6	15908			
RAM 1500	11-12	6	3.7	15954			
RAM 1500	14-17	6	3.6	15908			
RAM 1500	02-03	6	3.7	15829			
RAM 1500	04-10	6	3.7	15954			
RAM 1500	02-02	6	3.9	15829			
RAM 1500	94-96	6	3.9	15874			
RAM 1500	00-01	6	3.9	15885			
RAM 2500	09-13	8	5.7	15952			
RAM 2500	96-99	8	5.9	15639			
RAM 2500	00-02	8	5.9	15885			
RAM 3500	96-99	8	5.9	15639			
RAM 3500	00-02	8	5.9	15885			
RAM RUNNER	96-97	10	8.0	15833			
RAM VAN 1500	00-03	6	3.9	15885			
RAM VAN 2500	97-99	8	5.2	15639			
RAM VAN 3500	97-99	8	5.9	15639			
RAMCHARGER	99-99	8	5.2	15639			
RAMCHARGER	95-99	8	5.9	15639			
SHADOW	91-95	4	2.5	15596			
SHADOW GTS TURBO	89-90	4	2.2	15512			
SPIRIT	91-95	4	2.5	15596			
STRATUS	01-06	4	2.0	15894			
STRATUS	05-06	4	2.4	15889			
STRATUS	01-04	4	2.4	15894			
VERNA	04-06	4	1.5	15868			
VERNA	04-06	4	1.6	15868			

CONTINÚA»



# INYECTORES PARA SISTEMA MULTIPORT

CHRYSLER		JEEP			
MODELO	AÑO	CIL.	MOTOR	SISTEMA	No. PARTE
CHEROKEE SPORT	94-94	6	4.0	MPFI	15637
CHEROKEE SPORT	98-98	6	4.0		15639
COMMANDER	06-08	8	5.7		15853
GRAND CHEROKEE	11-15	6	3.6		15908
GRAND CHEROKEE	05-10	6	3.7		15954
GRAND CHEROKEE	93-95	6	4.0		15637
GRAND CHEROKEE	96-98	6	4.0		15639
GRAND CHEROKEE	99-00	8	4.7		15847
GRAND CHEROKEE	08-09	8	4.7		15853
GRAND CHEROKEE	96-98	8	5.2		15639
GRAND CHEROKEE	93-94	8	5.2		15641
GRAND CHEROKEE	05-08	8	5.7		15853
GRAND CHEROKEE	09-15	8	5.7		15952
GRAND CHEROKEE	98-98	8	5.9		15639
GRAND CHEROKEE SRT-8	06-10	8	6.1		15952
LIBERTY	02-03	6	3.7		15829
LIBERTY	04-12	6	3.7		15954
WRANGLER	97-02	4	2.5		15639
WRANGLER	12-15	6	3.6		15908
WRANGLER	98-98	6	4.0		15639
WRANGLER	05-06	6	4.0	15845	

FIAT					
MODELO	AÑO	CIL.	MOTOR	SISTEMA	No. PARTE
PALIO	04-06	4	1.8	MPFI	15907

FORD					
MODELO	AÑO	CIL.	MOTOR	SISTEMA	No. PARTE
AEROSTAR	91-95	6	4.0	MPFI	15505
AEROSTAR	91-91	6	3.0		15506
CONTOUR	95-95	4	2.0		15559
CONTOUR	98-98	4	2.0		15950
CONTOUR	95-97	6	2.5		15561
CONTOUR	96-97	4	2.0		15567
CONTOUR	98-00	6	2.5		15881
CONTOUR	99-00	4	2.0		15882
COURIER	01-12	4	1.6		15872
ECONOLINE E-150	95-96	6	4.9		15506
ECONOLINE E-150	97-00	6	4.2		15563
ECONOLINE E-150	99-03	6	4.2		15884
ECONOLINE E-150	05-08	8	4.6		15936
ECONOLINE E-250	97-98	6	4.2		15563
ECONOLINE E-250	99-04	8	5.4		15888
ECONOLINE E-350	97-03	8	5.4		15888
EDGE	07-10	6	3.5		15973
ESCAPE	01-04	6	3.0		15859
ESCAPE	05-08	4	2.3		15865
ESCAPE	09-15	4	2.5		15919
ESCAPE	09-12	6	3.0		15920
ESCAPE	05-08	6	3.0		15921
ESCORT	94-96	4	1.9		15506
ESCORT	01-01	4	2.0		15569
ESCORT	97-97	4	2.0		15569
ESCORT	98-98	4	2.0		15574
ESCORT	99-00	4	2.0		15878
EXCURSION	01-05	10	6.8		15863
EXPEDITION	99-02	8	4.6		15563
EXPEDITION	97-02	8	5.4		15888
EXPEDITION	05-06	8	5.4		15916
EXPLORER	91-92	6	4.0		15505
EXPLORER	99-00	6	4.0		15630
EXPLORER	06-10	6	4.0	15830	
EXPLORER	02-03	6	4.0	15858	
EXPLORER	04-04	6	4.0	15879	

FORD					
MODELO	AÑO	CIL.	MOTOR	SISTEMA	No. PARTE
EXPLORER	06-09	8	4.6	MPFI	15921
EXPLORER	04-05	8	4.6		15936
EXPLORER	96-98	8	5.0		15950
EXPLORER SPORT TRAC	07-09	8	4.6		15910
F-150	95-96	6	4.9		15506
F-150	97-00	6	4.2		15563
F-150	01-03	6	4.2		15884
F-150	97-03	8	4.6		15888
F-150	04-08	8	4.6		15936
F-250	88-88	8	5.8		15505
F-250	90-91	8	5.8		15505
F-250	88-89	8	5.8		15515
F-250	97-99	8	4.6		15888
F-250	89-97	8	5.8		15888
F-350	92-97	8	5.8		15888
F-350 SUPER DUTY	99-03	8	5.4		15888
F-350 SUPER DUTY	08-10	8	5.4		15909
F-350 SUPER DUTY	05-07	8	5.4		15916
F-450 SUPER DUTY	00-04	10	6.8		15863
F-550 SUPER DUTY	00-04	10	6.8		15863
FIESTA	03-07	4	1.6		15862
FOCUS	05-07	4	2.0		15865
FOCUS	08-11	4	2.0		15928
FOCUS DOHC	00-04	4	2.0		15882
FOCUS ST TURBO	07-07	5	2.5		15865
FOCUS ST TURBO	08-10	5	2.5		15928
FOCUS ZX3	00-04	4	2.0		15882
FREESTAR	04-05	6	4.2		15860
FUSION	10-12	4	2.5		15919
FUSION	10-12	6	3.0		15920
FUSION	06-09	4	2.3		15946
FUSION	06-09	6	3.0		15947
FUSION SPORT	10-12	6	3.5		15973
GHIA	91-91	4	2.3	15506	
GHIA	93-94	6	3.0	15506	
IKON	01-04	4	1.6	15872	
KA	01-08	4	1.6	15872	
LOBO	05-05	8	4.6	15936	
MICROBUS	92-94	8	5.0	15505	
MONDEO	01-04	6	2.5	15869	
MUSTANG	05-10	6	4.0	15830	
MUSTANG	99-04	8	4.6	15888	
MUSTANG	05-09	8	4.6	15910	
RANGER	01-02	6	3.0	15864	
RANGER	98-00	6	3.0	15923	
RANGER	07-11	4	2.3	15946	
TAURUS	88-91	6	3.8	15506	
THUNDERBIRD	91-93	8	5.0	15505	
THUNDERBIRD	94-95	8	4.6	15950	
THUNDERBIRD	89-96	6	3.8	15506	
WINDSTAR	95-98	6	3.8	15563	
WINDSTAR	99-03	6	3.8	15860	

FORD		LINCOLN			
MODELO	AÑO	CIL.	MOTOR	SISTEMA	No. PARTE
MARK LT	08-08	8	5.4	MPFI	15909
MARK LT	06-07	8	5.4		15916
MKS	09-12	6	3.7		15973
MKX	07-10	6	3.5		15973
NAVIGATOR	98-99	8	5.4		15888
NAVIGATOR	05-07	8	5.4		15916
TOWN CAR	00-02	8	4.6		15880
TOWN CAR	91-94	8	4.6		15888
TOWN CAR	95-98	8	4.6		15950
ZEPHYR	06-06	6	3.0		15947

CONTINÚA»

FORD		MERCURY				
MODELO	AÑO	CIL.	MOTOR	SISTEMA	No. PARTE	
COUGAR XR7	90-94	6	3.8		15506	
GRAND MARQUIS	03-04	8	4.6		15863	
GRAND MARQUIS	01-02	8	4.6		15880	
GRAND MARQUIS	92-97	8	4.6		15888	
GRAND MARQUIS	98-98	8	4.6		15950	
MARINER	09-11	6	3.0		15920	
MARINER	05-08	6	3.0		15921	
MILAN	07-08	6	3.0		15947	
MYSTIQUE	95-95	4	2.0		15559	
MYSTIQUE	95-97	6	2.5	MPFI	15561	
MYSTIQUE	98-00	6	2.5		15881	
MYSTIQUE	99-99	4	2.0		15881	
MYSTIQUE	00-00	4	2.0		15882	
MYSTIQUE	96-98	4	2.0		15950	
SABLE	96-98	6	3.0		15622	
SABLE	01-01	6	3.0		15859	
SABLE	04-04	6	3.0		15910	
TOPAZ	89-94	4	2.3		15506	

GENERAL MOTORS		BUICK				
MODELO	AÑO	CIL.	MOTOR	SISTEMA	No. PARTE	
CENTURY	87-95	6	2.8		15593	
ENCORE TURBO	14-16	4	1.4	MPFI	15971	
REGAL	94-95	6	3.8		15505	

GENERAL MOTORS		CADILLAC				
MODELO	AÑO	CIL.	MOTOR	SISTEMA	No. PARTE	
CTS	07-09	6	3.6		15924	
CTS	10-11	6	3.0		15959	
DEVILLE	93-95	8	4.9		15765	
ESCALADE	02-05	8	5.3		15871	
ESCALADE	02-06	8	6.0		15871	
ESCALADE	07-08	8	6.2		15934	
ESCALADE ESV	03-06	8	6.0	MPFI	15871	
ESCALADE ESV	07-08	8	6.2		15934	
ESCALADE ESV	09-14	8	6.2		15966	
ESCALADE EXT	03-06	8	6.0		15871	
ESCALADE EXT	07-08	8	6.2		15934	
ESCALADE EXT	09-13	8	6.2		15966	
SRX	10-11	6	3.0		15959	
STS	07-07	6	3.6		15924	

GENERAL MOTORS		CHEVROLET				
MODELO	AÑO	CIL.	MOTOR	SISTEMA	No. PARTE	
AVALANCHE	02-04	8	5.3		15871	
AVALANCHE	10-13	8	5.3		15914	
AVALANCHE	06-09	8	5.3		15934	
AVEO	08-11	4	1.6		15841	
BLAZER	96-01	6	4.3		15588	
CAMARO	95-95	6	3.4		15607	
CAMARO	95-97	8	5.7		15613	
CAVALIER	90-94	6	2.8		15593	
CAVALIER	03-04	4	2.2		15852	
CAVALIER	00-02	4	2.2		15892	
CAVALIER	95-97	4	2.2	MPFI	15902	
CAVALIER Z24	91-94	6	3.1		15593	
CAVALIER Z24	96-97	4	2.4		15611	
CELEBRITY	87-89	6	2.8		15593	
CHEVY	94-95	4	1.4		15591	
CHEVY	09-12	4	1.6		15838	
CHEVY	96-03	4	1.6		15890	
CHEVY C2	04-08	4	1.6		15861	
CHEVY MONZA	09-12	4	1.6		15838	
CHEVY MONZA	96-03	4	1.6		15890	
CHEVY PICK UP	99-03	4	1.6		15890	
CHEVY WAGON	00-03	4	1.6		15890	

GENERAL MOTORS		CHEVROLET				
MODELO	AÑO	CIL.	MOTOR	SISTEMA	No. PARTE	
COLORADO	09-12	4	2.9		15957	
COLORADO	09-12	5	3.7		15957	
CORSA	03-05	4	1.8		15907	
CORVETTE	94-96	8	5.7		15613	
CRUZE TURBO	14-15	4	1.4		15971	
EQUINOX	05-08	6	3.4		15931	
EXPRESS 1500	00-06	6	4.3		15588	
EXPRESS 1500	03-07	8	5.3		15871	
EXPRESS 1500	10-13	8	5.3		15914	
EXPRESS 2500	96-02	8	5.7		15588	
EXPRESS 3500	96-02	8	5.7		15588	
EXPRESS 3500	03-07	8	6.0		15871	
EXPRESS 3500	08-08	8	6.0		15934	
EXPRESS 3500	10-13	8	6.0		15972	
HHR	08-08	4	2.4		15930	
HHR	06-07	4	2.4		15937	
IMPALA	00-03	6	3.4		15891	
KODIAK	01-05	8	8.1		15870	
MALIBU	97-99	6	3.1		15607	
MALIBU	97-98	4	2.4		15611	
MALIBU	07-07	6	3.5		15826	
MALIBU	04-06	6	3.5		15842	
MALIBU	00-03	6	3.1		15891	
MALIBU	99-02	4	2.4		15893	
MALIBU	08-12	6	3.6		15924	
MALIBU	08-12	4	2.4		15930	
MALIBU	06-07	4	2.2		15937	
MALIBU	13-15	4	2.5		15958	
MALIBU	04-05	4	2.2		15968	
MATIZ	11-15	4	1.0		15840	
MERIVA	04-05	4	1.8		15907	
OPTRA	06-10	4	2.0		15841	
P30	96-99	8	5.7	MPFI	15588	
S10	95-97	4	2.2		15902	
SILVERADO 1500	99-13	6	4.3		15588	
SILVERADO 1500	14-16	6	4.3		15970	
SILVERADO 2500	03-07	8	4.8		15871	
SILVERADO 2500	99-00	8	5.3		15871	
SILVERADO 2500	11-14	8	5.3		15914	
SILVERADO 3500	99-02	8	5.7		15588	
SILVERADO 3500 HD	99-02	8	8.1		15588	
SILVERADO 3500 HD	04-07	8	8.1		15870	
SILVERADO 3500 HD	08-08	8	6.0		15934	
SONIC	12-17	4	1.6		15945	
SONIC RS TURBO	14-16	4	1.4		15971	
SONORA	00-02	8	5.7		15588	
SPARK CLASSIC	11-17	4	1.2		15943	
SUBURBAN	98-99	8	5.7		15588	
SUBURBAN	10-14	8	5.3		15914	
SUBURBAN	15-16	8	5.3		15970	
SUBURBAN 1500	00-05	8	5.3		15871	
SUBURBAN 1500	07-09	8	5.3		15934	
SUBURBAN 2500	00-06	8	6.0		15871	
SUBURBAN 2500	07-08	8	6.0		15934	
SUBURBAN 2500	10-13	8	6.0		15972	
TAHOE	10-15	8	5.3		15914	
TAHOE	07-09	8	5.3		15934	
TAHOE	15-16	8	5.3		15970	
TORNADO	04-05	4	1.8		15907	
TRAIL BLAZER	02-05	8	5.3		15871	
TRAIL BLAZER	02-04	6	4.2		15912	
TRAIL BLAZER	06-06	8	5.3		15934	
TRAIL BLAZER EXT	03-04	8	5.3		15871	
TRAIL BLAZER EXT	02-04	6	4.2		15912	
TRAIL BLAZER EXT	05-06	8	5.3		15934	
UPLANDER	07-09	6	3.9		15826	

# INYECTORES PARA SISTEMA MULTIPORT

GENERAL MOTORS		CHEVROLET				
MODELO	AÑO	CIL.	MOTOR	SISTEMA	No. PARTE	
UPLANDER	05-06	6	3.5	MPFI	15842	
UPLANDER	08-09	6	3.9		15935	
VENTURE	97-99	6	3.4		15765	
VENTURE	00-04	6	3.4		15891	

GENERAL MOTORS		GMC				
MODELO	AÑO	CIL.	MOTOR	SISTEMA	No. PARTE	
CANYON	09-12	5	3.7	MPFI	15957	
SIERRA 1500	07-07	8	5.3		15871	
SIERRA 1500	10-13	8	5.3		15914	
SIERRA 1500	07-09	8	5.3		15934	
SIERRA 1500	14-16	8	5.3		15970	
TERRAIN	11-11	6	3.0		15959	
YUKON	07-09	8	5.3		15934	
YUKON	07-08	8	6.2		15934	
YUKON	09-14	8	6.2		15966	

GENERAL MOTORS		HUMMER				
MODELO	AÑO	CIL.	MOTOR	SISTEMA	No. PARTE	
H2	05-06	8	6.0	MPFI	15871	
H2	08-08	8	6.2		15934	
H2	09-09	8	6.2		15966	
H3	10-10	8	5.3		15914	
H3	08-09	8	5.3		15934	
H3T	10-10	8	5.3		15914	
H3T	09-09	8	5.3		15934	
H3T	09-10	5	3.7		15957	

GENERAL MOTORS		OLDSMOBILE				
MODELO	AÑO	CIL.	MOTOR	SISTEMA	No. PARTE	
88	92-92	6	3.8	MPFI	15505	
CUTLASS	87-88	6	2.8		15593	
CUTLASS	89-96	6	3.1		15593	
SILHOUETTE	92-92	6	3.8		15505	

GENERAL MOTORS		PONTIAC				
MODELO	AÑO	CIL.	MOTOR	SISTEMA	No. PARTE	
AZTEK	01-05	6	3.4	MPFI	15891	
BONNEVILLE	94-94	6	3.8		15765	
G5	07-07	4	2.2		15937	
G5 GT	08-08	4	2.4		15930	
G6	06-09	6	3.5		15826	
G6	05-06	6	3.5		15842	
G6	07-09	6	3.6		15924	
GRAND AM	00-04	6	3.4		15891	
GRAND PRIX	97-99	6	3.1		15607	
GRAND PRIX	00-01	6	3.1		15891	
MATIZ	04-10	4	1.0		15840	
MONTANA	06-09	6	3.9		15826	
MONTANA	05-06	6	3.5		15842	
SOLSTICE	08-09	4	2.4		15930	
SOLSTICE	06-07	4	2.4		15937	
SUNFIRE	97-98	4	2.4		15611	
SUNFIRE	03-05	4	2.2		15852	
SUNFIRE	00-02	4	2.2		15892	
SUNFIRE	99-02	4	2.4		15893	
TORRENT	06-09	6	3.4		15931	

HONDA						
MODELO	AÑO	CIL.	MOTOR	SISTEMA	No. PARTE	
ACCORD	98-02	4	2.3	MPFI	15836	
ACCORD	98-02	6	3.0		15836	
ACCORD	03-07	4	2.4		15849	
CIVIC	97-00	4	1.6		15828	
CIVIC EX	97-98	4	1.6		15835	
CIVIC EX	99-00	4	1.6		15836	

HONDA						
MODELO	AÑO	CIL.	MOTOR	SISTEMA	No. PARTE	
CR-V	02-09	4	2.4	MPFI	15849	
ODYSSEY	01-01	6	3.5		15836	

MAZDA						
MODELO	AÑO	CIL.	MOTOR	SISTEMA	No. PARTE	
6	06-08	6	3.0	MPFI	15869	
6	09-13	6	3.7		15973	
CX-9	07-07	6	3.5		15973	
CX-9	08-15	6	3.7		15973	

NISSAN		INFINITI				
MODELO	AÑO	CIL.	MOTOR	SISTEMA	No. PARTE	
I30	00-01	6	3.0	MPFI	15866	
I30	98-99	6	3.0		15903	
Q45	02-02	8	4.5		15866	
Q45	01-01	8	4.1		15903	

NISSAN						
MODELO	AÑO	CIL.	MOTOR	SISTEMA	No. PARTE	
240SX	93-93	4	2.4	MPFI	15903	
240SX	98-98	4	2.4		15903	
300ZX	93-96	6	3.0		15903	
350Z	03-04	6	3.5		15866	
ALTIMA	96-99	4	2.4		15903	
ALTIMA	00-01	4	2.4		15905	
ALTIMA	02-06	4	2.5		15942	
ALTIMA	07-16	6	3.5		15969	
ARMADA	05-15	8	5.6		15967	
D21	94-96	4	2.4		15595	
D21	97-08	4	2.4		15905	
FRONTIER	01-04	6	3.3		15767	
FRONTIER	13-14	4	2.4		15905	
FRONTIER	11-11	4	2.4		15905	
FRONTIER	06-08	4	2.4		15905	
FRONTIER	02-04	4	2.4		15905	
FRONTIER	08-15	6	4.0		15967	
LUCINO GSR	96-00	4	2.0		15903	
MARCH	12-18	4	1.6		15960	
MAXIMA	00-01	6	3.0		15866	
MAXIMA	92-99	6	3.0		15903	
MAXIMA	09-16	6	3.5		15969	
NOTE	14-18	4	1.6		15960	
NP300	09-15	4	2.4		15905	
NV2500	13-15	6	4.0		15967	
NV2500	13-15	8	5.6		15967	
PATHFINDER	97-00	6	3.3	15767		
PATHFINDER	01-04	6	3.5	15866		
PATHFINDER	05-12	6	4.0	15967		
PATHFINDER	13-16	6	3.5	15969		
PATHFINDER ARMADA	04-04	8	5.6	15967		
PLATINA	02-10	4	1.6	15887		
QUEST	99-02	6	3.3	15767		
QUEST	97-98	6	3.0	15767		
SENTRA	96-96	4	1.6	15598		
SENTRA	01-02	4	1.8	15866		
SENTRA	00-01	4	2.0	15866		
SENTRA	96-99	4	2.0	15903		
SENTRA	07-12	4	2.0	15915		
SENTRA	03-06	4	1.8	15963		
SENTRA SE-R	02-06	4	2.5	15942		
TIIDA	07-18	4	1.8	15915		
TIIDA	13-18	4	1.6	15960		
TITAN	04-15	8	5.6	15967		
TSUBAME	95-97	4	1.6	15598		
TSURU III	95-97	4	1.6	15598		
TSURU III GSR 2000	94-96	4	2.0	15597		

**INYECTORES PARA SISTEMA MULTIPORT**

NISSAN					
MODELO	AÑO	CIL.	MOTOR	SISTEMA	No. PARTE
URVAN	00-07	4	2.4	MPFI	15866
VERSA	12-18	4	1.6		15960
XTERRA	00-04	6	3.3		15767
XTERRA	00-04	4	2.4		15905
XTERRA	05-07	6	4.0		15967

PEUGEOT					
MODELO	AÑO	CIL.	MOTOR	SISTEMA	No. PARTE
206	02-04	4	1.6	MPFI	15832

RENAULT					
MODELO	AÑO	CIL.	MOTOR	SISTEMA	No. PARTE
CLIO	02-10	4	1.6	MPFI	15887
MEGANE	01-03	4	2.0		15887
MEGANE II	04-10	4	2.0		15887

SEAT					
MODELO	AÑO	CIL.	MOTOR	SISTEMA	No. PARTE
CORDOBA	04-09	4	2.0	MPFI	15938
IBIZA	03-09	4	2.0		15938
IBIZA	10-15	4	2.0		15939

TOYOTA					
MODELO	AÑO	CIL.	MOTOR	SISTEMA	No. PARTE
CAMRY	04-09	4	2.4	MPFI	15925
CAMRY	02-06	6	3.0		15926
CAMRY	12-16	6	3.5		15964
CAMRY	10-16	4	2.5		15965
COROLLA	05-08	4	1.8		15929
COROLLA	03-04	4	1.8		15933
COROLLA	09-16	4	1.8		15955
COROLLA XRS	09-13	4	2.4		15925
HIACE	06-16	4	2.7		15956
HIGHLANDER	11-15	6	3.5		15964
MATRIX	09-10	4	2.4		15925
MATRIX	05-08	4	1.8		15929
MATRIX	03-06	4	1.8		15933
MATRIX	09-10	4	1.8		15955
MR2 SPYDER	05-06	4	1.8		15933
RAV4	04-08	4	2.4		15925
RAV4	09-17	4	2.5		15965
SIENNA	04-06	6	3.3		15926
SIENNA	11-16	6	3.5		15964
SOLARA	05-06	6	3.3		15926

VOLKSWAGEN					
MODELO	AÑO	CIL.	MOTOR	SISTEMA	No. PARTE
BEEBLE	06-07	5	2.5	MPFI	15827
BEEBLE	04-05	4	2.0		15837
BEEBLE	08-09	4	2.0		15837
BEEBLE	99-01	4	2.0		15899
BEEBLE	08-13	5	2.5		15953
BORA	06-10	5	2.5		15827
COMBI	93-98	4	1.8		15594
GOLF A2	90-92	4	2.0		15202
GOLF A3	93-98	4	2.0		15594
GOLF A4	03-06	4	2.0		15837
GOLF A4	00-03	4	2.0		15899
GOLF A5 SPORT WAGEN	10-12	5	2.5		15953
JETTA A3	93-99	4	2.0		15594
JETTA A4	04-10	4	2.0		15837
JETTA A4	99-03	4	2.0		15899
JETTA A4 CLASICO	10-15	4	2.0		15939
JETTA A6	11-16	5	2.5		15953
PASSAT	91-93	4	2.0		15202
PASSAT	12-16	5	2.5		15953

VOLKSWAGEN					
MODELO	AÑO	CIL.	MOTOR	SISTEMA	No. PARTE
POINTER	98-09	4	1.8	MPFI	15896
POINTER GTI	00-03	4	2.0		15895
POINTER PICK UP	99-03	4	1.8		15896
ROUTAN	11-12	6	3.6		15908
SEDAN	93-04	4	1.6		15592
VAN	03-09	4	1.8		15896

# INYECTORES PARA SISTEMA MULTIPOINT





**INYECTORES PARA SISTEMA MULTIPORT**

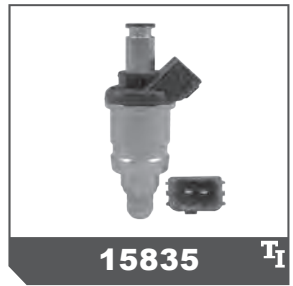
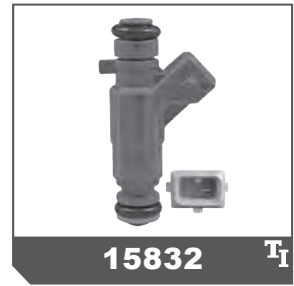

# INYECTORES PARA SISTEMA MULTIPOINT

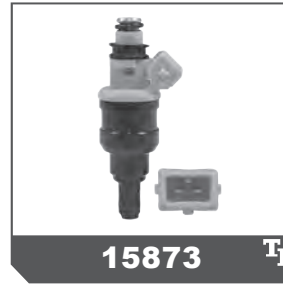

**INYECTORES PARA SISTEMA MULTIPOINT**

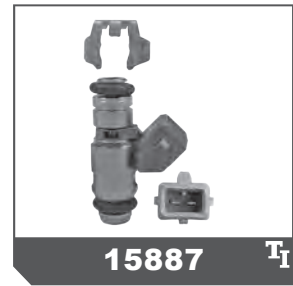

# INYECTORES PARA SISTEMA MULTIPOINT

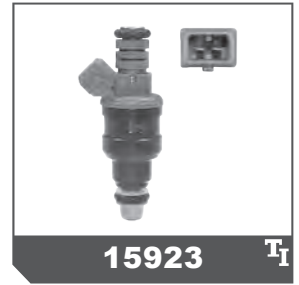

**INYECTORES PARA SISTEMA MULTIPOINT**

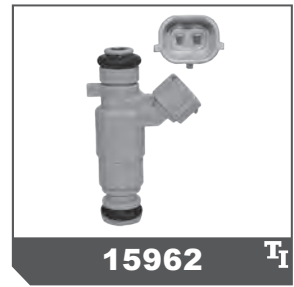
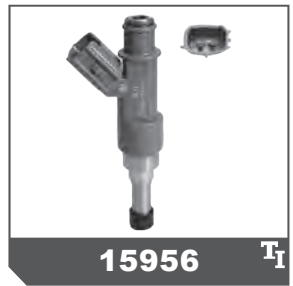
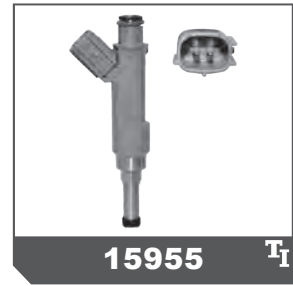



# INYECTORES PARA SISTEMA MULTIPORT

**TOMCO**   
ESPECIALISTAS EN INYECCIÓN

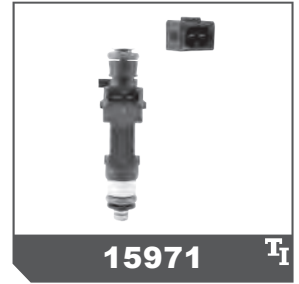
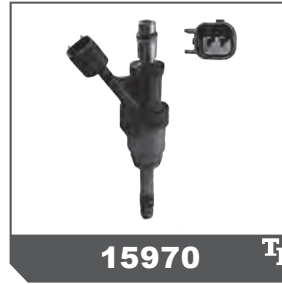

**INYECTORES PARA SISTEMA TBI**

**SU FUNCIÓN:**

Proveer de gasolina al motor.

Una señal eléctrica de la computadora activa al solenoide ocasionando que la válvula se mueva de su posición permitiendo a la gasolina fluir de manera cónica.

La presión de la gasolina es constante, el flujo es controlado por el tiempo y el solenoide es energizado.

**SÍNTOMAS DE FALLA:**

El motor no arranca, jaloneo, aumento de emisiones contaminantes y ahogamiento de motor.

**MANTENIMIENTO/SERVICIO:**

Inspeccionar cada 40, 000 - 50, 000 kms. que la gasolina sea inyectada en forma pulverizada.

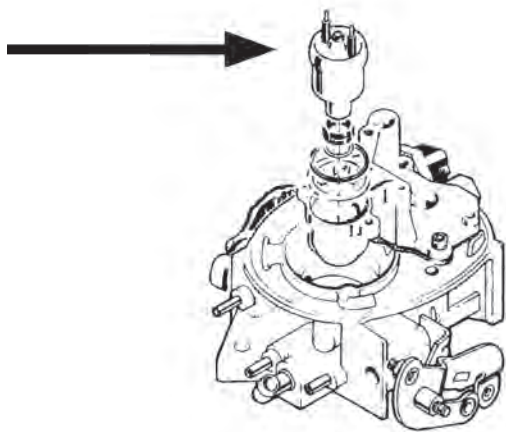

CHRYSLER		DODGE			
MODELO	AÑO	CIL.	MOTOR	SISTEMA	No. PARTE
RAM CHARGER	91-94	8	5.9	TBI	15099
D-250	91-93	8	5.9		15099
D-350	91-93	8	5.9		15099
MICROBUS	91-94	8	5.9		15099

GENERAL MOTORS		CHEVROLET			
MODELO	AÑO	CIL.	MOTOR	SISTEMA	No. PARTE
C2500	94-98	8	5.7	TBI	15004
C3500	94-98	8	5.7		15004
MICROBUS	92-99	8	5.7		15004
P30	92-99	8	5.7		15004
SUBURBAN	92-99	8	5.7		15004
CHEVY	96-03	4	1.6		15009
CHEVY	96-03	4	1.4		15009
CHEVY MONZA	96-03	4	1.6		15009
BLAZER NEVADA	91-94	6	3.1		15012
S10 MAXICAB	91-93	6	3.1		15012

GENERAL MOTORS		OLDSMOBILE			
MODELO	AÑO	CIL.	MOTOR	SISTEMA	No. PARTE
SILHOUETTE	91-92	6	3.1	TBI	15012

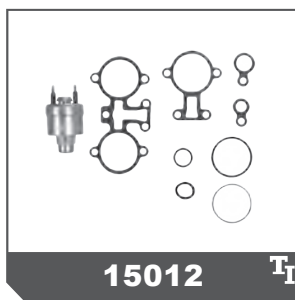
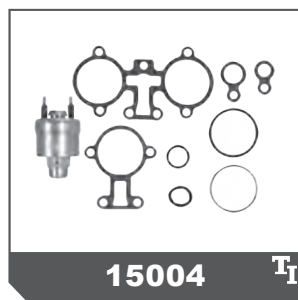

# JUNTAS PARA VÁLVULA EGR

NÚMERO DE JUNTA	COMPATIBLE CON:
2-1121	10609
2-1347	10551
2-1357	10515, 10516, 10518, 10519, 10520

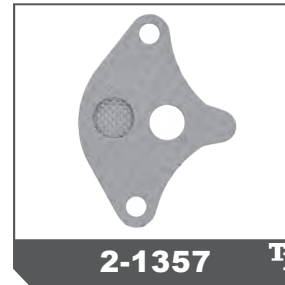
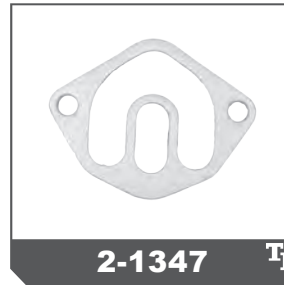
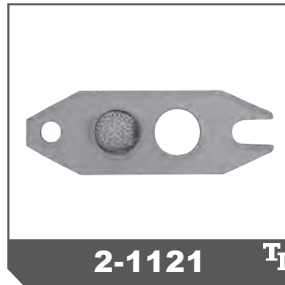

# PEDAL DEL ACELERADOR

AUDI					
MODELO	AÑO	CIL.	MOTOR	SISTEMA	No. PARTE
A3 TURBO	00-04	4	1.8	MPFI	23002
A4 TURBO	00-06	4	1.8		23002

SEAT					
MODELO	AÑO	CIL.	MOTOR	SISTEMA	No. PARTE
CORDOBA	03-06	4	2.0	MPFI	23002
IBIZA	03-15	4	2.0		23002

GENERAL MOTORS CHEVROLET					
MODELO	AÑO	CIL.	MOTOR	SISTEMA	No. PARTE
SONIC	12-17	4	1.6	MPFI	23000

VOLKSWAGEN					
MODELO	AÑO	CIL.	MOTOR	SISTEMA	No. PARTE
BEETLE	99-05	4	2.0	MPFI	23002
BEETLE TURBO	99-05	4	1.8		23002
GOLF A4	00-05	4	2.0		23002
GOLF A4 GTI	00-05	4	1.8		23002
JETTA A4	00-10	4	2.0		23002
JETTA A4 TURBO	00-05	4	1.8		23002
JETTA A4 CLASICO	10-15	4	2.0		23002

NISSAN					
MODELO	AÑO	CIL.	MOTOR	SISTEMA	No. PARTE
MARCH	12-18	4	1.6	MPFI	23001
TIIDA	13-18	4	1.6		23001
TIIDA T/M	<b>NUEVO</b> 07-17	4	1.8		23003
VERSA	12-18	4	1.6		23001

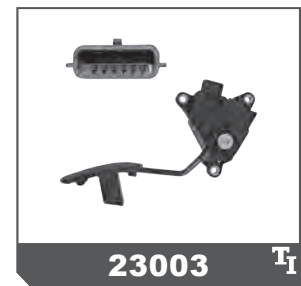

**NUEVO**

**SU FUNCIÓN:**

Mantener la presión de gasolina requerida para el sistema de inyección.

**SÍNTOMAS DE FALLA:**

El vehículo tarda mucho en arrancar, jaloneo al acelerar.

**MANTENIMIENTO/SERVICIO:**

Checar la presión del riel de inyectores en cada afinación.  
Reemplazar si la presión está fuera de especificaciones.

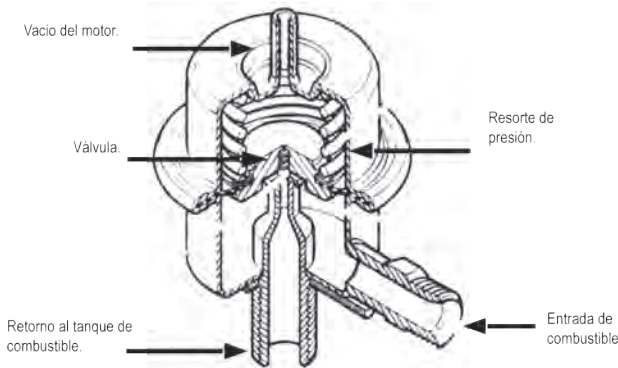
**ACURA**

MODELO	AÑO	CIL.	MOTOR	SISTEMA	No. PARTE
TL	05-08	6	3.2	MPFI	21957
TSX	10-13	4	2.4		21931

**AUDI**

MODELO	AÑO	CIL.	MOTOR	SISTEMA	No. PARTE
TT TURBO	00-06	4	1.8	MPFI	21995
TT QUATTRO TURBO	00-06	4	1.8		21995

**BMW**

MODELO	AÑO	CIL.	MOTOR	SISTEMA	No. PARTE
M3	01-06	6	3.2	MPFI	21950
M5	00-03	8	4.9		21950
M5	00-03	8	5.0		21950
Z3	01-02	6	3.2		21950
Z8	01-03	8	4.9		21950

**CHRYSLER**

MODELO	AÑO	CIL.	MOTOR	SISTEMA	No. PARTE
CIRRUS	96-00	4	2.4	MPFI	21944
CIRRUS	96-00	6	2.5		21944
CONCORDE	95-97	6	3.5		21994
GRAND VOYAGER	91-93	6	3.3		21098
GRAND VOYAGER	94-95	6	3.8		21098
GRAND VOYAGER	98-99	6	3.8		21944
LEBARON K	87-87	4	2.2		21019
LEBARON TURBO	84-86	4	2.2		21016
LEBARON TURBO	92-94	4	2.5		21100
NEW YORKER K	85-86	4	2.2		21016
NEW YORKER K	87-88	4	2.2		21019
NEW YORKER LH	95-97	6	3.5		21994
NEW TURBO	91-94	4	2.5		21100
PHANTOM TURBO	87-88	4	2.2		21019
PHANTOM TURBO	90-94	4	2.5		21100
TOWN & COUNTRY	93-93	6	3.3	21098	

**CHRYSLER**

MODELO	AÑO	CIL.	MOTOR	SISTEMA	No. PARTE
TOWN & COUNTRY	94-95	6	3.8	MPFI	21098
TOWN & COUNTRY	96-00	6	3.8		21944
VOYAGER	94-95	6	3.3		21098
VOYAGER	96-00	6	3.3		21944

**CHRYSLER**
**DODGE**

MODELO	AÑO	CIL.	MOTOR	SISTEMA	No. PARTE
ATOS	01-04	4	1.0	MPFI	21989
ATOS	05-12	4	1.1		21989
H100 CHASIS	03-05	4	2.4		21973
INTREPID	95-97	6	3.5		21994
MAGNUM K	84-86	4	2.2		21016
MAGNUM K	87-88	4	2.2	21019	
MICROBUS	91-94	8	5.9	TBI	21020
NEON	95-96	4	2.0	MPFI	21944
RAMCHARGER	91-94	8	5.9	TBI	21020
SHADOW GTS	89-90	4	2.2	MPFI	21100
SHADOW TURBO	91-94	4	2.5		21100
SPIRIT R/T	91-94	4	2.5		21100
STRATUS	95-00	4	2.0		21944
STRATUS	95-00	4	2.4		21944
VAN 1000	08-09	4	2.4		21973
VERNA	04-06	4	1.6		21972

**CHRYSLER**
**JEEP**

MODELO	AÑO	CIL.	MOTOR	SISTEMA	No. PARTE
CHEROKEE SPORT	94-94	6	4.0	MPFI	21096
GRAND CHEROKEE	93-96	8	5.2		21096
GRAND CHEROKEE	93-96	6	4.0		21096
WRANGLER	93-96	4	2.5		21096

**FORD**

MODELO	AÑO	CIL.	MOTOR	SISTEMA	No. PARTE
AEROSTAR	91-95	6	3.0	MPFI	21000
AEROSTAR	91-95	6	4.0		21048
CONTOUR	95-00	6	2.5		21073
CONTOUR	95-97	4	2.0		21996
ECONOLINE E-150	97-98	6	4.2		21997
ECONOLINE E-250	99-04	8	5.4		21971
ECONOLINE E-250	97-98	6	4.2		21997
ECONOLINE E-350	99-03	8	5.4		21971
ECOSPORT	04-08	4	2.0		21958
ESCORT	94-96	4	1.9		21000
ESCORT	97-97	4	2.0		21073
EXPEDITION	97-98	8	5.4		21073
EXPEDITION	99-02	8	4.6		21971
EXPEDITION	99-05	8	5.4		21971
EXPLORER	91-98	6	4.0		21048
EXPLORER	96-98	8	5.0		21073
F-150	97-98	6	4.2		21073
F-150	97-98	8	4.6		21073
F-150	99-03	8	4.6		21971
F-250	92-93	8	5.0		21000
F-250	95-96	8	5.0		21073
F-250	97-98	8	4.6		21073
F-250	94-97	8	5.8		21073
F-250	99-99	8	4.6		21971
F-250	94-94	8	5.0		21997
F-350	92-93	8	5.0		21000
F-350	94-97	8	5.8	21073	
F-350	94-94	8	5.0	21997	
F-350 SUPER DUTY	99-99	8	5.4	21073	
F-350 SUPER DUTY	00-04	8	5.4	21971	
GHIA	93-94	6	3.0	21000	
GHIA	91-91	4	2.3	21006	
MICROBUS	92-93	8	5.0	21000	

CONTINÚA))

FORD					
MODELO	AÑO	CIL.	MOTOR	SISTEMA	No. PARTE
MUSTANG	96-98	8	4.6	MPFI	21073
MUSTANG	98-98	8	4.6		21976
RANGER	94-97	4	2.3		21073
RANGER	96-97	6	3.0		21073
TAURUS	88-91	6	3.8		21000
THUNDERBIRD	88-93	6	3.8		21000
THUNDERBIRD	91-93	8	5.0		21000
THUNDERBIRD	94-96	6	3.8		21073
THUNDERBIRD	95-96	8	4.6		21997
THUNDERBIRD SC	89-93	6	3.8		21000
WINDSTAR	95-98	6	3.8		21073

FORD		LINCOLN			
MODELO	AÑO	CIL.	MOTOR	SISTEMA	No. PARTE
NAVIGATOR	98-98	8	5.4	MPFI	21073
NAVIGATOR	99-04	8	5.4		21971
TOWN CAR	94-97	8	4.6		21073
TOWN CAR	98-02	8	4.6		21976

FORD		MERCURY			
MODELO	AÑO	CIL.	MOTOR	SISTEMA	No. PARTE
COUGAR XR7	90-93	6	3.8	MPFI	21000
COUGAR XR7	94-95	6	3.8		21073
GRAND MARQUIS	92-93	8	4.6		21000
GRAND MARQUIS	98-02	8	4.6		21976
GRAND MARQUIS	94-97	8	4.6		21997
MYSTIQUE	95-00	6	2.5		21073
MYSTIQUE	95-95	4	2.0		21996
SABLE	96-99	6	3.0		21073
TOPAZ	89-94	4	2.3		21006

GENERAL MOTORS		BUICK			
MODELO	AÑO	CIL.	MOTOR	SISTEMA	No. PARTE
CENTURY	91-95	6	3.1	MPFI	21009
CENTURY	94-95	6	3.1		21172

GENERAL MOTORS		CADILLAC			
MODELO	AÑO	CIL.	MOTOR	SISTEMA	No. PARTE
ESCALADE	02-03	8	5.3	MPFI	21986
ESCALADE	02-03	8	6.0		21986

GENERAL MOTORS		CHEVROLET				
MODELO	AÑO	CIL.	MOTOR	SISTEMA	No. PARTE	
AVALANCHE	02-03	8	5.3	MPFI	21986	
BLAZER	95-95	6	4.3		21960	
BLAZER	96-01	6	4.3	TBI	21986	
BLAZER NEVADA	91-94	6	3.1		21025	
C2500	94-98	8	5.7		21025	
C2500	94-98	8	5.0	MPFI	21025	
C2500	87-93	8	5.7		21025	
C2500	96-98	8	5.7	MPFI	21986	
C2500	96-98	8	5.0		21986	
C3500	94-95	8	5.7	TBI	21025	
C3500	96-98	8	5.7	MPFI	21986	
CAMARO	96-97	8	5.7		21172	
CAVALIER	90-94	6	2.8		21009	
CAVALIER	95-97	4	2.2		21044	
CAVALIER	98-04	4	2.2		21172	
CAVALIER Z24	91-94	6	3.1		21009	
CAVALIER Z24	96-97	4	2.4		21090	
CELEBRITY	89-89	6	2.8		21009	
CHEVY	96-03	4	1.6		TBI	21026
CHEVY	96-03	4	1.4		TBI	21026
CHEVY	09-12	4	1.6		MPFI	21979
CHEVY	94-95	4	1.4			21990
CHEVY	96-03	4	1.6			21995

GENERAL MOTORS		CHEVROLET			
MODELO	AÑO	CIL.	MOTOR	SISTEMA	No. PARTE
CHEVY C2	04-08	4	1.6	MPFI	21979
CHEVY MONZA	96-03	4	1.6	TBI	21026
CHEVY MONZA	96-03	4	1.6	MPFI	21995
CHEVY PICK UP	99-03	4	1.6		21995
CHEVY WAGON	00-03	4	1.6		21995
CORSA	03-06	4	1.8		21964
CORVETTE	92-92	8	5.7		21044
EXPRESS 1500	96-05	6	4.3		21986
EXPRESS 1500	03-04	8	5.3		21986
EXPRESS 2500	96-02	8	5.7		21986
EXPRESS 3500	03-03	8	6.0		21986
EXPRESS 3500	96-02	8	5.7		21986
IMPALA	00-03	6	3.8		21091
IMPALA	00-03	6	3.4		21172
LUMINA	96-96	6	3.4	21091	
MALIBU	97-98	4	2.4	21090	
MALIBU	97-03	6	3.1	21172	
MERIVA	04-06	4	1.8	21964	
MICROBUS	92-99	8	5.7	TBI	21025
P30	92-95	8	5.7	TBI	21025
P30	96-99	8	5.7	MPFI	21986
S10	96-01	4	2.2	MPFI	21095
S10 MAXICAB	91-93	6	3.1	TBI	21025
SILVERADO 1500	99-06	6	4.3	MPFI	21986
SILVERADO 2500	00-00	8	5.3		21986
SILVERADO 3500	01-03	8	5.7		21986
SILVERADO 3500	01-05	8	6.0		21986
SILVERADO 3500	01-03	8	8.1		21986
SONORA	00-02	8	5.7		21986
SUBURBAN	92-99	8	5.7	TBI	21025
SUBURBAN	96-99	8	5.7	MPFI	21091
SUBURBAN	98-99	8	5.7		21986
SUBURBAN 1500	00-05	8	5.3		21986
SUBURBAN 2500	00-05	8	6.0		21986
TRACKER	99-04	4	2.0		21954
TRACKER	02-04	6	2.5		21954
TRAIL BLAZER	02-05	6	4.2		21172
TRAIL BLAZER EXT	02-05	6	4.2		21172
TRAIL BLAZER EXT	03-05	8	5.3		21986
VENTURE	97-04	6	3.4		21172
ZAFIRA	02-05	4	1.8		21964

GENERAL MOTORS		GEO			
MODELO	AÑO	CIL.	MOTOR	SISTEMA	No. PARTE
TRACKER	93-95	4	1.6	MPFI	21953

GENERAL MOTORS		HUMMER			
MODELO	AÑO	CIL.	MOTOR	SISTEMA	No. PARTE
H2	03-03	8	6.0	MPFI	21091

GENERAL MOTORS		OLDSMOBILE			
MODELO	AÑO	CIL.	MOTOR	SISTEMA	No. PARTE
88	95-95	6	3.8	MPFI	21976
CUTLASS	89-95	6	3.1		21009
SILHOUETTE	91-92	6	3.8	TBI	21025

GENERAL MOTORS		PONTIAC			
MODELO	AÑO	CIL.	MOTOR	SISTEMA	No. PARTE
AZTEK	01-05	6	3.4	MPFI	21172
BONNEVILLE	95-95	6	3.8		21976
GRAND AM	99-04	6	3.4		21172
GRAND PRIX	97-01	6	3.1		21172
GRAND PRIX SC	01-01	6	3.8		21986
SUNFIRE	97-98	4	2.4		21090
SUNFIRE	95-97	4	2.2		21090
SUNFIRE	98-02	4	2.2		21172



**REGULADORES DE PRESIÓN DE GASOLINA**

<b>HONDA</b>					
MODELO	AÑO	CIL.	MOTOR	SISTEMA	No. PARTE
ACCORD	08-08	4	2.4	MPFI	21931
ACCORD	10-12	4	2.4		21931
ACCORD	00-02	6	3.0		21948
ACCORD	96-97	4	2.2		21961
ACCORD	03-07	4	2.4		21969
ACCORD	98-02	4	2.3		21978
CIVIC	01-03	4	1.7		21955
CIVIC	06-06	4	1.8		21957
CIVIC	07-09	4	2.0		21957
CIVIC EX	97-00	4	1.6		21961
CIVIC EXR	97-00	4	1.6		21977
CR-V	12-16	4	2.4		21931
CR-V	07-11	4	2.4		21956
FIT	09-14	4	1.5		21931
FIT	06-08	4	1.5		21956
ODYSSEY	02-04	6	3.5		21948
ODYSSEY	05-11	6	3.5		21957
PILOT	03-04	6	3.5	21948	
RIDGELINE	10-13	6	3.5	21957	

<b>MAZDA</b>					
MODELO	AÑO	CIL.	MOTOR	SISTEMA	No. PARTE
3	12-16	4	2.0	MPFI	21932
3	14-16	4	2.5		21932
3 TURBO	08-13	4	2.3		21932
6	06-07	4	2.3		21932
6	14-17	4	2.5		21932
CX-5	13-17	4	2.0		21932
CX-5	14-17	4	2.5		21932
CX-7	10-10	4	2.5		21932
CX-7 TURBO	07-12	4	2.3	21932	

<b>MITSUBISHI</b>					
MODELO	AÑO	CIL.	MOTOR	SISTEMA	No. PARTE
ENDEAVOR	04-08	6	3.8	MPFI	21945
GALANT	04-09	4	2.4		21945
GALANT	04-07	6	3.8		21945
LANCER	04-07	4	2.0		21946

<b>NISSAN</b>		<b>INFINITI</b>			
MODELO	AÑO	CIL.	MOTOR	SISTEMA	No. PARTE
I30	98-99	6	3.0	MPFI	21062
Q45	01-01	8	4.1		21963

<b>NISSAN</b>					
MODELO	AÑO	CIL.	MOTOR	SISTEMA	No. PARTE
240SX	93-93	4	2.4	MPFI	21999
240SX	98-98	4	2.4		21999
ALTIMA	96-97	4	2.4		21942
ALTIMA	98-01	4	2.4		21963
D21	97-08	4	2.4		21985
D21	94-96	4	2.4		21993
FRONTIER	01-04	4	2.4		21951
FRONTIER	01-04	6	3.3		21962
MAXIMA	95-99	6	3.0		21062
MAXIMA	92-94	6	3.0		21943
NP300	09-15	4	2.4		21951
PATHFINDER	97-00	6	3.3		21962
PATHFINDER	01-04	6	3.5		21999
PLATINA	02-10	4	1.6		21965
QUEST	97-98	6	3.0		21962
QUEST	99-02	6	3.3		21962
SENTRA	01-06	4	1.8	21985	
SENTRA	96-99	4	1.6	21999	
SENTRA	96-99	4	2.0	21999	
SENTRA	92-92	4	1.6	21999	

<b>NISSAN</b>					
MODELO	AÑO	CIL.	MOTOR	SISTEMA	No. PARTE
TSUBAME	95-97	4	1.6	MPFI	21999
TSURU III	98-16	4	1.6		21984
TSURU III	95-97	4	1.6		21999
TSURU III GSR 2000	94-96	4	2.0		21999
URVAN	00-04	4	2.4		21951
XTERRA	00-04	4	2.4		21951
XTERRA	00-04	6	3.3		21962

<b>RENAULT</b>					
MODELO	AÑO	CIL.	MOTOR	SISTEMA	No. PARTE
CLIO	02-10	4	1.6	MPFI	21965
MEGANE	01-03	4	2.0		21965
MEGANE II	04-10	4	2.0		21965
SCENIC	01-06	4	2.0		21965

<b>SEAT</b>					
MODELO	AÑO	CIL.	MOTOR	SISTEMA	No. PARTE
IBIZA	01-11	4	1.6	MPFI	21995
IBIZA	03-08	4	2.0		21995

<b>SUZUKI</b>					
MODELO	AÑO	CIL.	MOTOR	SISTEMA	No. PARTE
AERIO	06-07	4	2.3	MPFI	21954
GRAND VITARA	06-08	6	2.7		21954

<b>TOYOTA</b>					
MODELO	AÑO	CIL.	MOTOR	SISTEMA	No. PARTE
4RUNNER	03-09	8	4.7	MPFI	21947
CAMRY	07-11	4	2.4		21956
CAMRY	10-16	4	2.5		21956
CAMRY	02-06	4	2.4		21959
CAMRY	02-06	6	3.0		21959
CAMRY	07-11	6	3.5		21959
COROLLA	07-16	4	1.8		21956
COROLLA	03-06	4	1.8		21959
COROLLA XRS	09-13	4	2.4		21956
HIGHLANDER	08-10	6	3.5		21956
LAND CRUISER	08-16	8	5.7		21930
LAND CRUISER	04-07	8	4.7		21947
MATRIX	07-10	4	1.8		21956
MATRIX	09-10	4	2.4		21956
MATRIX	03-06	4	1.8		21959
MR2 SPYDER	05-05	4	1.8		21959
PRIUS HIBRIDO	10-16	4	1.8		21956
RAV4	06-08	4	2.4		21956
RAV4	09-12	6	3.5		21956
RAV4	09-17	4	2.5		21956
SEQUOIA	08-11	8	5.7		21930
SEQUOIA	11-11	8	4.6		21930
SEQUOIA	08-09	8	4.7	21947	
SIENNA	07-10	6	3.5	21956	
SOLARA	05-06	6	3.3	21959	
TUNDRA	11-12	8	5.7	21930	
TUNDRA	07-09	8	4.7	21947	
YARIS	06-17	4	1.5	21956	

<b>VOLKSWAGEN</b>					
MODELO	AÑO	CIL.	MOTOR	SISTEMA	No. PARTE
BEETLE	98-05	4	2.0	MPFI	21995
BEETLE TURBO	99-05	4	1.8		21995
COMBI CON BASE METALICA	93-98	4	1.8	TBI	21991
DERBY	95-97	4	1.8		21980
DERBY CON BASE METALICA	98-09	4	1.8	MPFI	21991
EUROVAN	04-04	5	2.5		21995
GOLF A2	87-92	4	1.8	TBI	21051
GOLF A3	93-97	4	1.8	MPFI	21980

CONTINÚA»

VOLKSWAGEN					
MODELO	AÑO	CIL.	MOTOR	SISTEMA	No. PARTE
GOLF A3	93-98	4	1.8	MPFI	21995
GOLF A3	93-99	4	2.0		21995
GOLF A3 CON BASE METALICA	93-98	4	1.8		21991
GOLF A3 VR6	96-99	6	2.8		21995
GOLF A4	00-06	4	2.0		21995
GOLF A4 GTI	00-05	4	1.8		21995
JETTA A2	90-92	4	1.8	TBI	21051
JETTA A3	93-97	4	1.8	MPFI	21980
JETTA A3	93-99	4	1.8		21995
JETTA A3	93-99	4	2.0		21995
JETTA A3 CON BASE METALICA	93-99	4	1.8		21991
JETTA A3 VR6	96-98	6	2.8		21995
JETTA A4	99-10	4	2.0		21995
JETTA A4 CLASICO	10-15	4	2.0		21995
JETTA TURBO	99-05	4	1.8		21995
JETTA A4 VR6	99-04	6	2.8		21995
LUPO	05-09	4	1.6		21995
PASSAT TURBO	99-03	4	1.8		21995
PASSAT VR6	96-97	6	2.8		21995
POINTER	98-09	4	1.8		21988
POINTER GTI	00-03	4	2.0		21988
POINTER PICK UP	99-03	4	1.8		21988
POLO	03-07	4	2.0		21995
SEDAN	93-04	4	1.6	21995	
SEDAN CON BASE DE PLASTICO	93-04	4	1.6	21992	
VAN	03-09	4	1.8	21995	

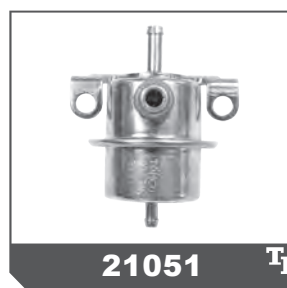
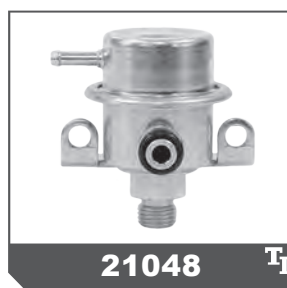
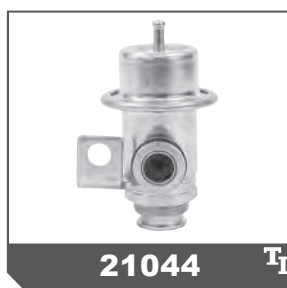
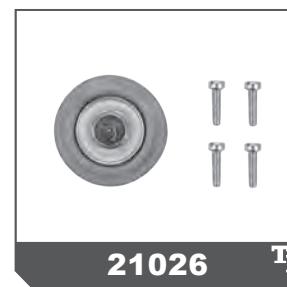
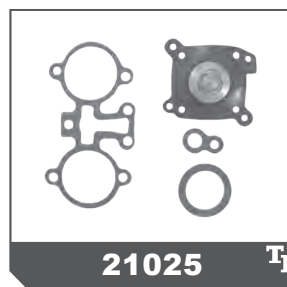
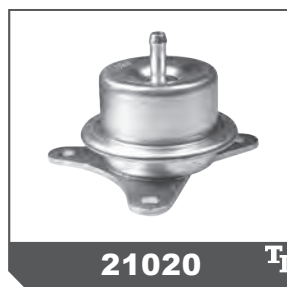
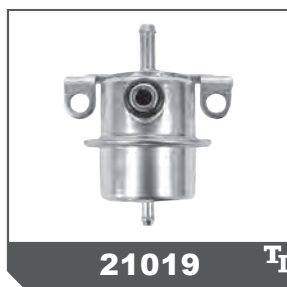
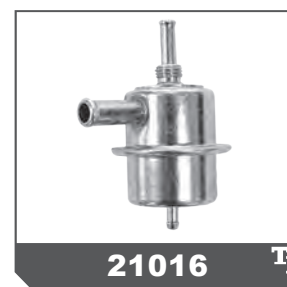
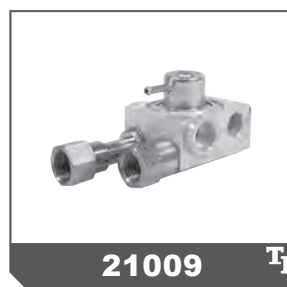
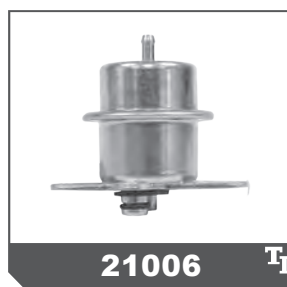
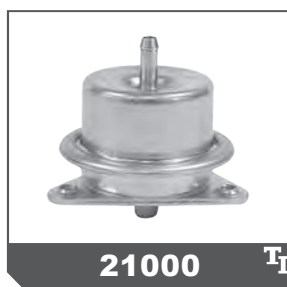

**REGULADORES DE PRESIÓN DE GASOLINA**

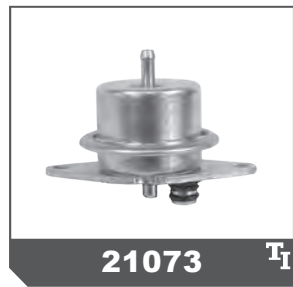

**21073** <sup>TI</sup>

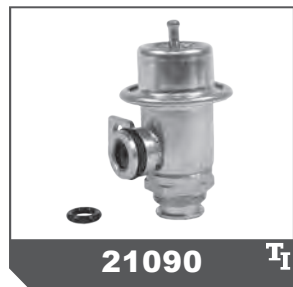

**21090** <sup>TI</sup>



**21091** <sup>TI</sup>



**21095** <sup>TI</sup>

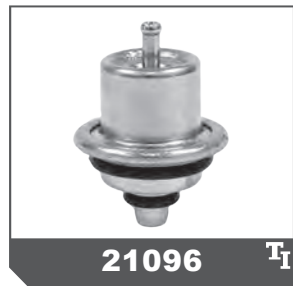

**21096** <sup>TI</sup>

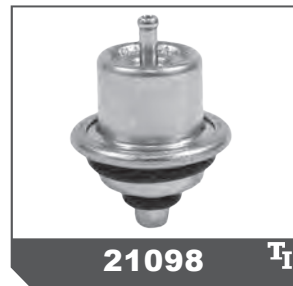

**21098** <sup>TI</sup>

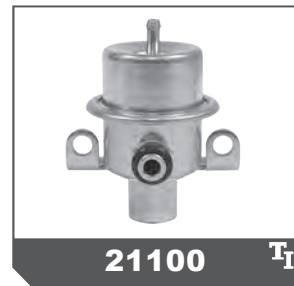

**21100** <sup>TI</sup>

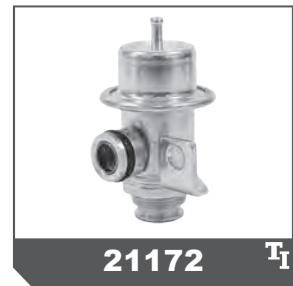

**21172** <sup>TI</sup>



**21930** <sup>TI</sup>



**21931** <sup>TI</sup>

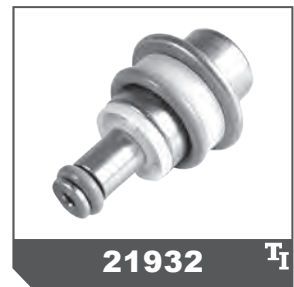

**21932** <sup>TI</sup>

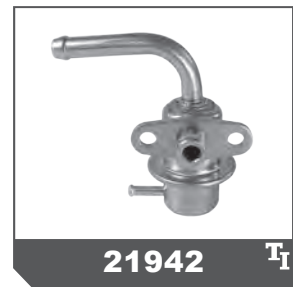

**21942** <sup>TI</sup>



**21943** <sup>TI</sup>



**21944** <sup>TI</sup>



**21945** <sup>TI</sup>



**21946** <sup>TI</sup>

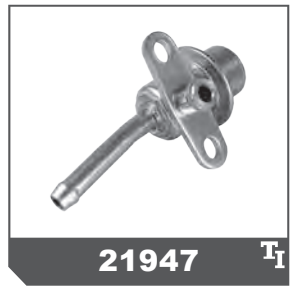

**21947** <sup>TI</sup>



**21948** <sup>TI</sup>

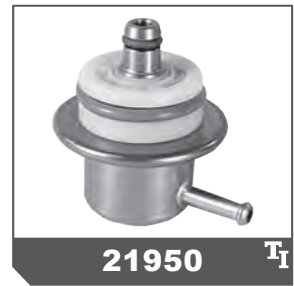

**21950** <sup>TI</sup>



**21951** <sup>TI</sup>

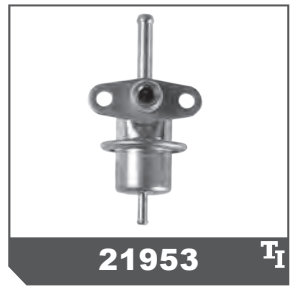

**21953** <sup>TI</sup>

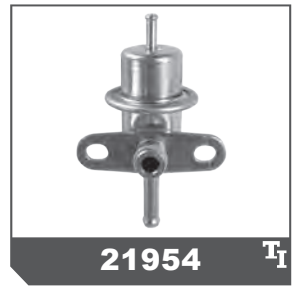

**21954** <sup>TI</sup>



**21955** <sup>TI</sup>



**21956** <sup>TI</sup>

# REGULADORES DE PRESIÓN DE GASOLINA

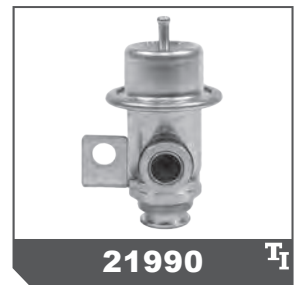
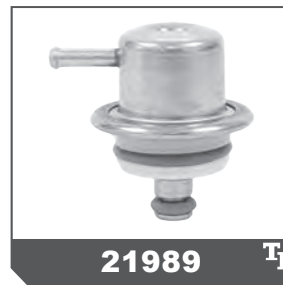
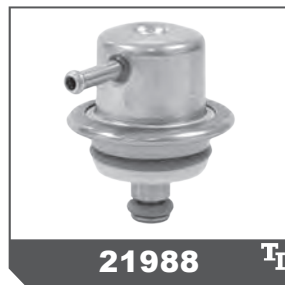
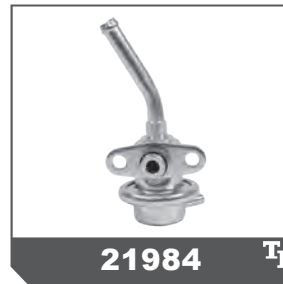
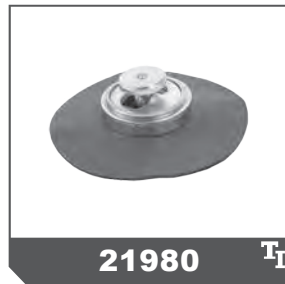
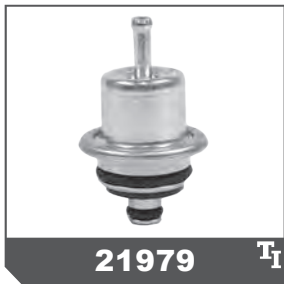
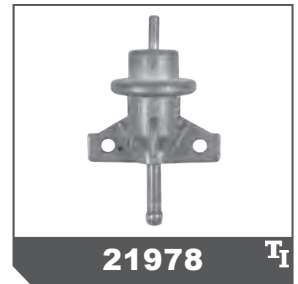
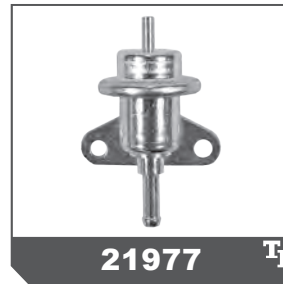
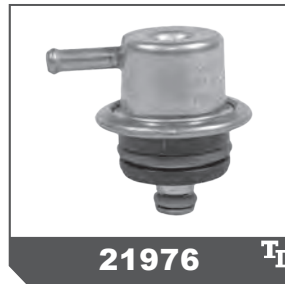
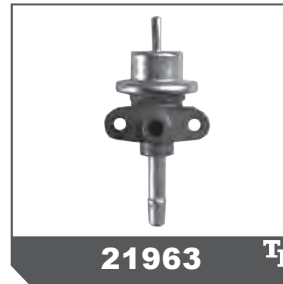

**REGULADORES DE PRESIÓN DE GASOLINA**

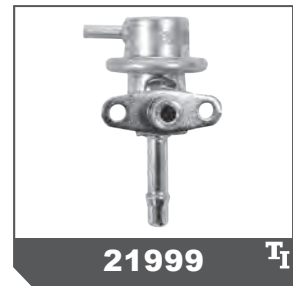
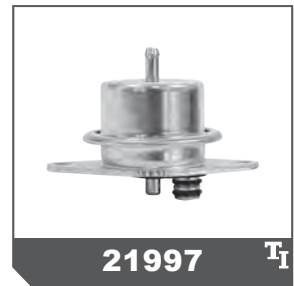
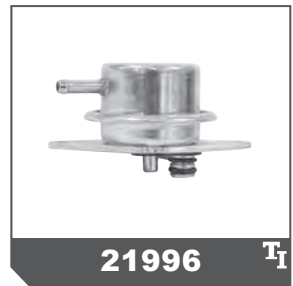
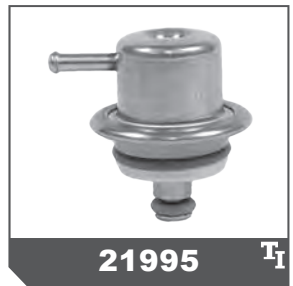
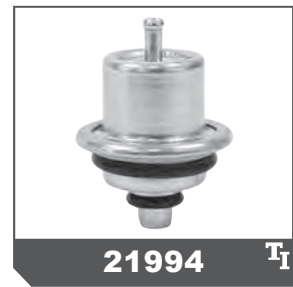
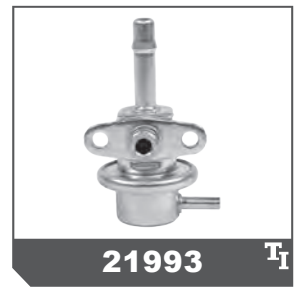
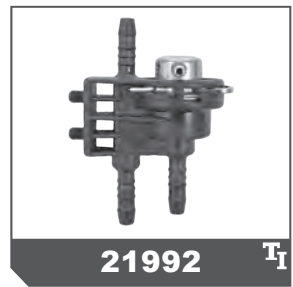

## AUDI

MODELO	AÑO	CIL.	MOTOR	SISTEMA	No. PARTE
A4 VR6 MODULO DE CONTROL ELECTRONICO ECM	98-01	6	2.8	MPFI	8602

## SEAT

MODELO	AÑO	CIL.	MOTOR	SISTEMA	No. PARTE
CORDOBA MODULO DE CONTROL ELECTRONICO ECM	01-03	4	1.6	MPFI	8602
CORDOBA MODULO DE CONTROL ELECTRONICO ECM	03-09	4	2.0		8602
IBIZA MODULO DE CONTROL ELECTRONICO ECM	01-03	4	1.6		8602
IBIZA MODULO DE CONTROL ELECTRONICO ECM	03-09	4	2.0		8602

## VOLKSWAGEN

MODELO	AÑO	CIL.	MOTOR	SISTEMA	No. PARTE
COMBI MODULO DE CONTROL ELECTRONICO ECM	93-01	4	1.8	MPFI	8602
DERBY MODULO DE CONTROL ELECTRONICO ECM	95-09	4	1.8		8602
DERBY MODULO DE CONTROL ELECTRONICO ECM	01-03	4	2.0		8602
EUROVAN MODULO DE CONTROL ELECTRONICO ECM	01-04	5	2.5		8602
EUROVAN VR6 MODULO DE CONTROL ELECTRONICO ECM	00-02	6	2.8		8602
GOLF A3 BOMBA DE GASOLINA No.103	93-98	4	1.8		8607
GOLF A3 BOMBA DE GASOLINA No.103	93-98	4	2.0		8607
GOLF A3 MODULO DE CONTROL ELECTRONICO ECM	91-99	4	1.8		8602
GOLF A3 MODULO DE CONTROL ELECTRONICO ECM	93-98	4	2.0		8602
GOLF A4 MODULO DE CONTROL ELECTRONICO ECM	01-07	4	2.0		8602
GOLF A4 GTI MODULO DE CONTROL ELECTRONICO ECM	00-06	4	1.8		8602
JETTA A3 BOMBA DE GASOLINA No.103	93-99	4	1.8		8607
JETTA A3 BOMBA DE GASOLINA No.103	93-99	4	2.0		8607
JETTA A3 MODULO DE CONTROL ELECTRONICO ECM	91-99	4	1.8		8602
JETTA A3 MODULO DE CONTROL ELECTRONICO ECM	93-99	4	2.0		8602
JETTA A3 VR6 MODULO DE CONTROL ELECTRONICO ECM	94-99	6	2.8		8602
JETTA A4 TURBO MODULO DE CONTROL ELECTRONICO ECM	99-99	4	1.8		8602
JETTA A4 TURBO MODULO DE CONTROL ELECTRONICO ECM	03-05	4	1.8		8602
JETTA A4 VR6 MODULO DE CONTROL ELECTRONICO ECM	00-04	6	2.8		8602
LUPO MODULO DE CONTROL ELECTRONICO ECM	05-09	4	1.6		8602
PASSAT TURBO MODULO DE CONTROL ELECTRONICO ECM	99-05	4	1.8		8602
PASSAT VR6 MODULO DE CONTROL ELECTRONICO ECM	97-97	6	2.8		8602
PASSAT VR6 MODULO DE CONTROL ELECTRONICO ECM	99-00	6	2.8		8602
PASSAT VR6 MODULO DE CONTROL ELECTRONICO ECM	03-05	6	2.8		8602
SEDAN BOMBA DE GASOLINA No.103	93-04	4	1.6		8607
SEDAN MODULO DE CONTROL ELECTRONICO ECM	93-04	4	1.6		8602
VAN MODULO DE CONTROL ELECTRONICO ECM	03-09	4	1.8		8602

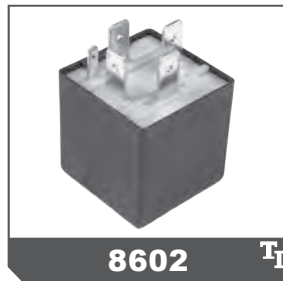



**REPUESTOS FUEL INJECTION**

CHRYSLER					
MODELO	AÑO	CIL.	MOTOR	SISTEMA	No. PARTE
LEBARON K	84-87	4	2.2	MPFI	5591A
LEBARON TURBO	92-94	4	2.5		5591A
NEW YORKER K	85-89	4	2.2		5591A
NEW YORKER TURBO	91-94	4	2.5		5591A
PHANTOM TURBO	87-89	4	2.2		5591A
PHANTOM TURBO	90-94	4	2.5		5591A

CHRYSLER		DODGE			
MODELO	AÑO	CIL.	MOTOR	SISTEMA	No. PARTE
ATOS	01-04	4	1.0	MPFI	5703
ATOS	05-12	4	1.1		5703
ATTITUDE	06-11	4	1.6		5715
H100 CHASIS	03-05	4	2.4	TBI	5705
MAGNUM K	84-88	4	2.2		5591A
MICROBUS	91-94	8	5.9	MPFI	5599
RAMCHARGER	91-94	8	5.9		5599
SHADOW	91-94	4	2.5		5591A
SHADOW TURBO	91-94	4	2.5		5591A
SPIRIT	91-94	4	2.5		5591A
SPIRIT R/T	91-94	4	2.5		5591A
VERNA	04-06	4	1.6		5715

FORD					
MODELO	AÑO	CIL.	MOTOR	SISTEMA	No. PARTE
COURIER	01-12	4	1.6	MPFI	5712
ESCORT	94-96	4	1.9		5548A
ESCORT GT	94-95	4	1.8		5626
EXPEDITION	04-14	8	5.4		5709
F-250	92-94	8	5.0		5582
F-350	92-94	8	5.0		5582
F-350 SUPER DUTY	04-10	8	5.4		5709
FIESTA	03-06	4	1.6		5712
Ghia	93-94	6	3.0		5581
Ghia	91-91	4	2.3		5610
IKON	01-06	4	1.6		5712
KA	01-08	4	1.6		5712
MICROBUS	92-94	8	5.0		5582
MUSTANG	96-96	8	4.6		5617
TAURUS	88-91	6	3.8		5609
THUNDERBIRD	91-93	8	5.0		5582
THUNDERBIRD	89-96	6	3.8	5609	
THUNDERBIRD	95-96	8	4.6	5617	

FORD		LINCOLN			
MODELO	AÑO	CIL.	MOTOR	SISTEMA	No. PARTE
NAVIGATOR	04-14	8	5.4	MPFI	5709

FORD		MERCURY			
MODELO	AÑO	CIL.	MOTOR	SISTEMA	No. PARTE
COUGAR XR7	90-90	6	3.8	MPFI	5609
GRAND MARQUIS	92-96	8	4.6		5617
TOPAZ	89-94	4	2.3		5610

GENERAL MOTORS		BUICK			
MODELO	AÑO	CIL.	MOTOR	SISTEMA	No. PARTE
CENTURY	87-89	6	2.8	MPFI	5594
CENTURY	91-95	6	3.1		5594

GENERAL MOTORS		CHEVROLET			
MODELO	AÑO	CIL.	MOTOR	SISTEMA	No. PARTE
ASTRA	07-08	4	1.8	MPFI	5716
ASTRA	00-03	4	1.8		5717
ASTRA	04-06	4	2.0		5717
ASTRA	04-06	4	2.4		5718
AVEO	08-17	4	1.6		5708
BEAT	18-18	4	1.2		5721

GENERAL MOTORS		CHEVROLET			
MODELO	AÑO	CIL.	MOTOR	SISTEMA	No. PARTE
BLAZER NEVADA	91-94	6	3.1	TBI	5526
BLAZER NEVADA VERSION REDUCIDA	91-94	6	3.1		526MX
C2500	94-98	8	5.7		5526
C2500 VERSION REDUCIDA	94-98	8	5.7		526MX
C3500	94-98	8	5.7		5526
C3500 VERSION REDUCIDA	94-98	8	5.7		526MX
CAVALIER	90-94	6	2.8	MPFI	5594
CAVALIER Z24	91-94	6	3.1		5594
CELEBRITY	87-88	6	2.8		5594
CHEVY	96-03	4	1.6	TBI	5527
CHEVY	96-03	4	1.4		5527
CHEVY VERSION REDUCIDA	96-03	4	1.6		527MX
CHEVY VERSION REDUCIDA	96-03	4	1.4		527MX
CHEVY C2	04-08	4	1.6	MPFI	5702
CHEVY MONZA	96-03	4	1.6	TBI	5527
CHEVY MONZA VERSION REDUCIDA	96-03	4	1.6		527MX
CHEYENNE CUSTOM	92-99	8	5.7		5526
CHEYENNE CUSTOM VERSION REDUCIDA	92-99	8	5.7	526MX	
CORSA	03-06	4	1.8	MPFI	5702
MATIZ	11-15	4	1.0		5706
MERIVA	04-06	4	1.8		5702
MICROBUS	92-99	8	5.7	TBI	5526
MICROBUS VERSION REDUCIDA	92-99	8	5.7		526MX
OPTRA	06-10	4	2.0	MPFI	5708
P30	92-99	8	5.7	TBI	5526
P30 VERSION REDUCIDA	92-99	8	5.7		526MX
S10 MAXICAB	91-93	6	3.1		5526
S10 MAXICAB VERSION REDUCIDA	91-93	6	3.1		526MX
SPARK CLASSIC	11-17	4	1.2	MPFI	5721
SUBURBAN	92-99	8	5.7	TBI	5526
SUBURBAN VERSION REDUCIDA	92-99	8	5.7		526MX

GENERAL MOTORS		OLDSMOBILE			
MODELO	AÑO	CIL.	MOTOR	SISTEMA	No. PARTE
CUTLASS	87-88	6	2.8	MPFI	5594
CUTLASS	89-95	6	3.1		5594

GENERAL MOTORS		PONTIAC			
MODELO	AÑO	CIL.	MOTOR	SISTEMA	No. PARTE
MATIZ	04-10	4	1.0	MPFI	5706

HONDA					
MODELO	AÑO	CIL.	MOTOR	SISTEMA	No. PARTE
CR-V	02-06	4	2.4	MPFI	5725

NISSAN					
MODELO	AÑO	CIL.	MOTOR	SISTEMA	No. PARTE
240SX	93-93	4	2.4	MPFI	5662
D21	97-08	4	2.4		5724
FRONTIER	01-15	4	2.4		5724
LUCINO GSE	96-00	4	1.6		5662
LUCINO GSR	96-00	4	2.0		5662
MARCH	12-18	4	1.6		5719
NP300	09-15	4	2.4		5724
PLATINA	02-10	4	1.6		5701
SENTRA	96-97	4	1.6		5662
SENTRA	96-97	4	2.0		5662
SENTRA	07-12	4	2.0		5720
TIIDA	13-18	4	1.6		5719
TIIDA	07-18	4	1.8		5720
TSUBAME	95-97	4	1.6		5662
TSURU III	95-97	4	1.6		5662
TSURU III	98-16	4	1.6		5713
TSURU III TAPA ROJA	93-94	4	1.6	5700	
URVAN	02-07	4	2.4	5714	
VERSA	12-18	4	1.6	5719	

CONTINÚA»

RENAULT					
MODELO	AÑO	CIL.	MOTOR	SISTEMA	No. PARTE
CLIO	02-10	4	1.6	MPFI	5701

SEAT					
MODELO	AÑO	CIL.	MOTOR	SISTEMA	No. PARTE
IBIZA	09-15	4	2.0	MPFI	5711

VOLKSWAGEN					
MODELO	AÑO	CIL.	MOTOR	SISTEMA	No. PARTE
BETLE	99-07	4	2.0	MPFI	5711
COMBI	96-98	4	1.8		5590
DERBY	96-98	4	1.8		5590
DERBY	02-03	4	2.0		5590
GOL	09-17	4	1.6		5722
GOLF A3	96-98	4	1.8		5590
GOLF A3	96-98	4	2.0		5590
GOLF A4	00-03	4	2.0		5711
JETTA A3	96-99	4	1.8		5590
JETTA A3	96-99	4	2.0		5590
JETTA A4	99-10	4	2.0		5711
JETTA A4 CLASICO	10-15	4	2.0		5711
JETTA A6	<b>NUEVO</b> 11-16	5	2.5		5726
POINTER	98-09	4	1.8		5704
POINTER PICK UP	99-04	4	1.8		5704
SEDAN	93-04	4	1.6		5590
SEDAN VERSION REDUCIDA	93-04	4	1.6	590MX	
VENTO	14-17	4	1.6	5723	

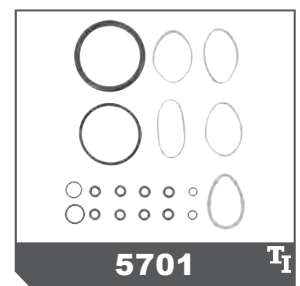
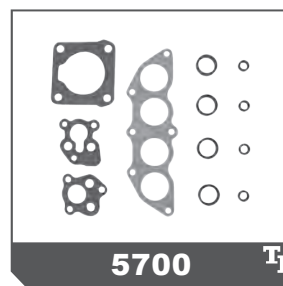
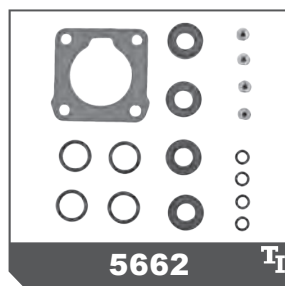
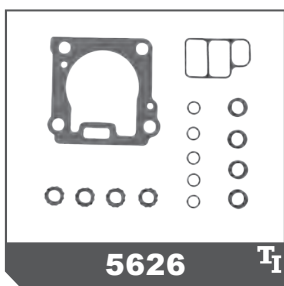
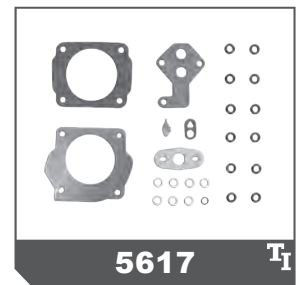
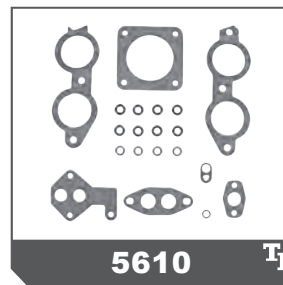
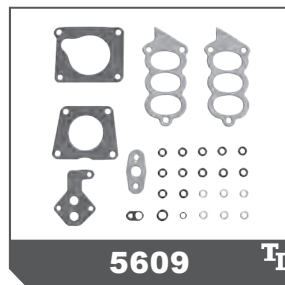
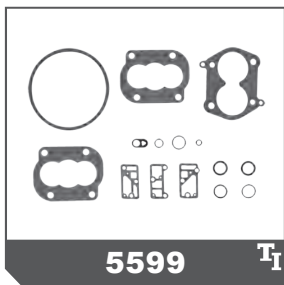
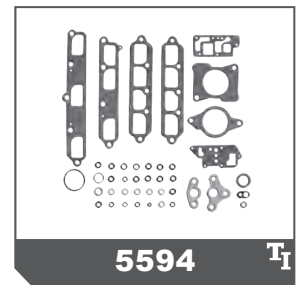
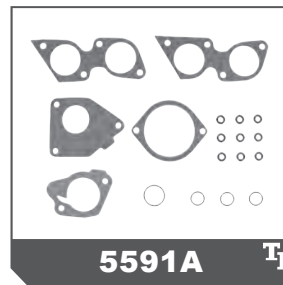
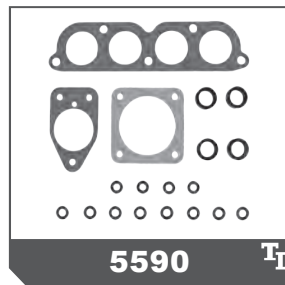
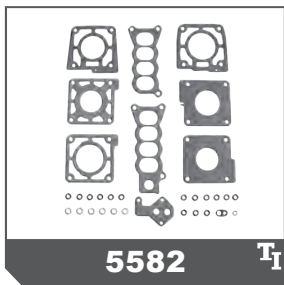
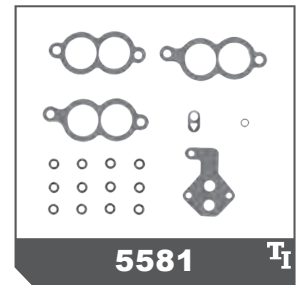
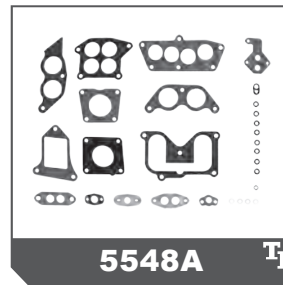
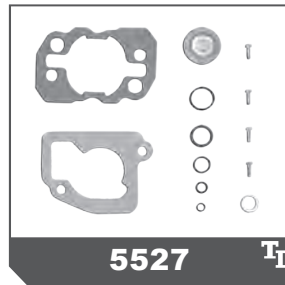
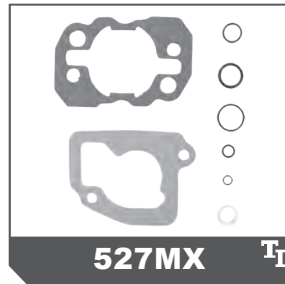
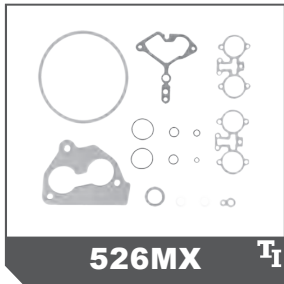

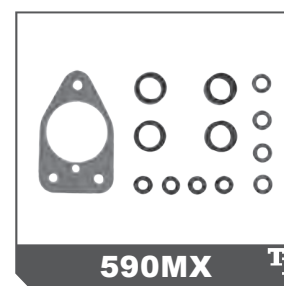
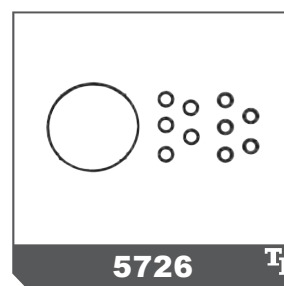
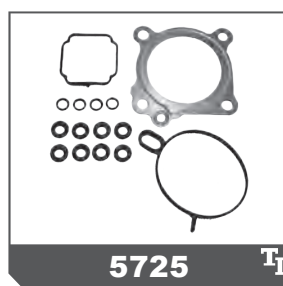
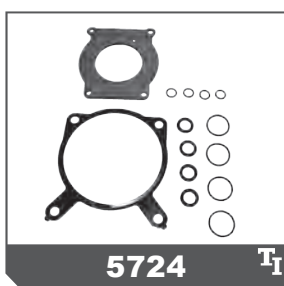
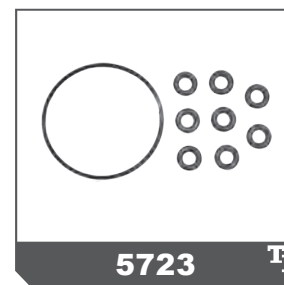
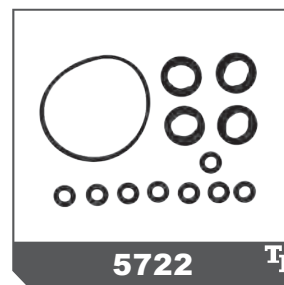
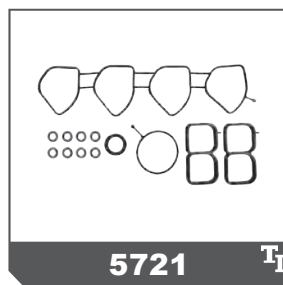
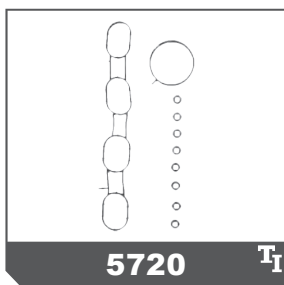
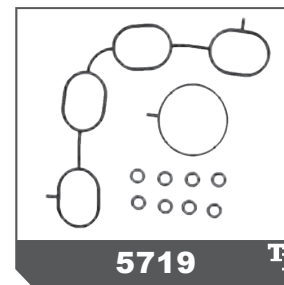
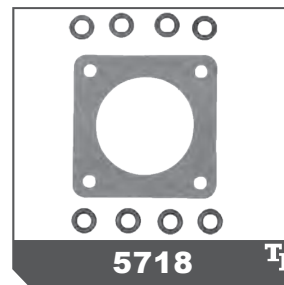
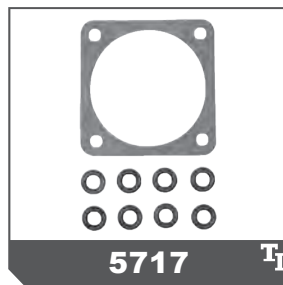
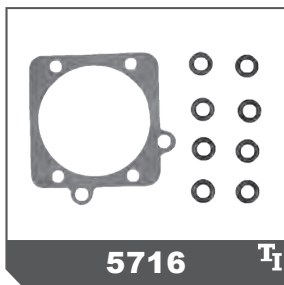
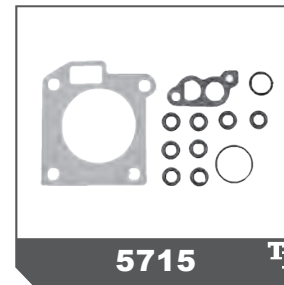
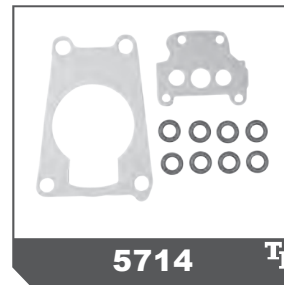
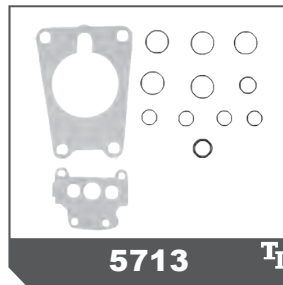
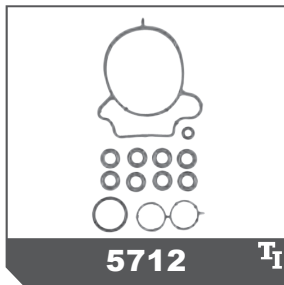
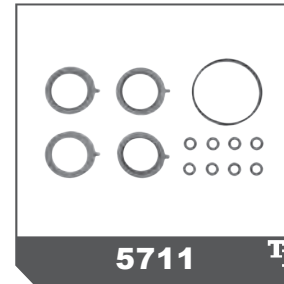
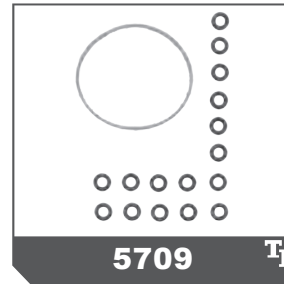
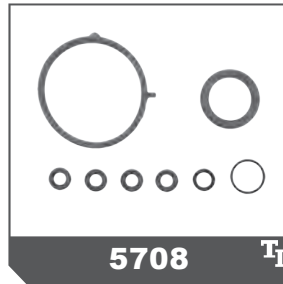
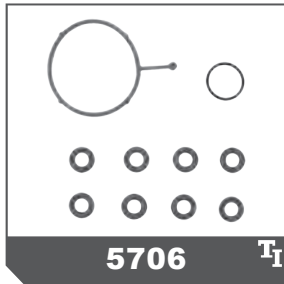
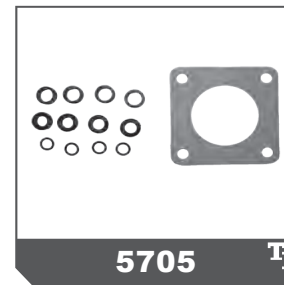
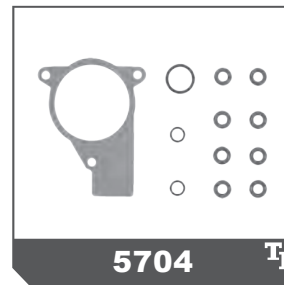
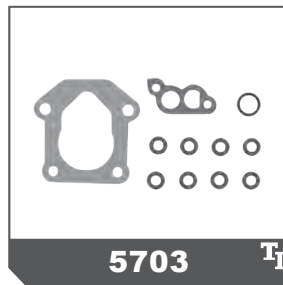
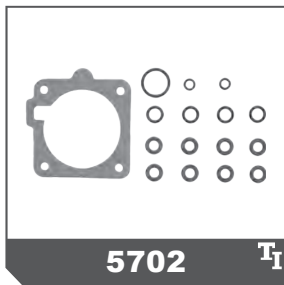

NUEVO

# REPUESTOS PARA INYECTOR MULTIPOINT

NUMERO DE REPUESTO	COMPATIBLE CON:
27007	ORIGINAL, TIPO BOSCH (ORIGINALES)
27008	ORIGINAL, 15512
27028	15767
27029	15661
27030	15902
27031	TIPO DELPHI 15871, 15892, 15861, 15891, 15870, 15893
27032	15894, 15881, 15574, 15863, 15880, 15622
27033	15888
27034	15903, 15598, 15597
27035	15885, 15829, 15630, 15879, 15883, 15850
27039	15655, 15561
27040	15599
27102	ORIGINAL, 15512

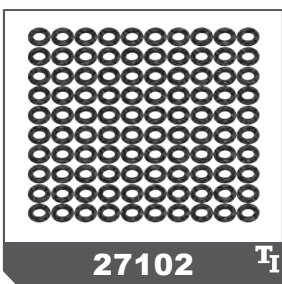
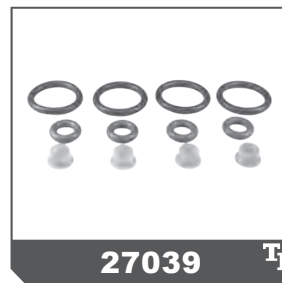
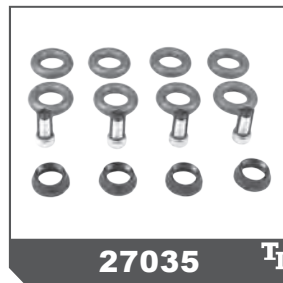
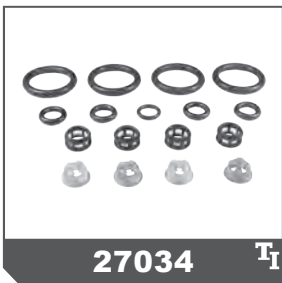
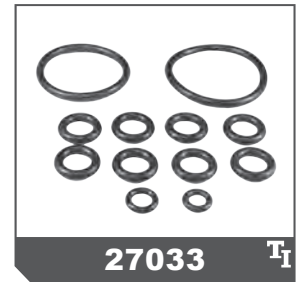
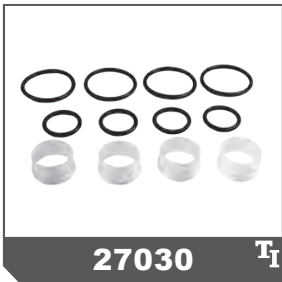
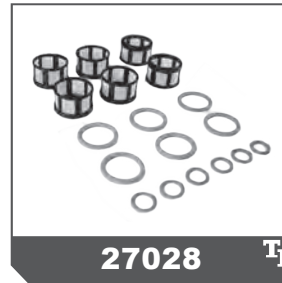
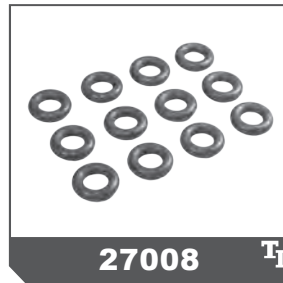
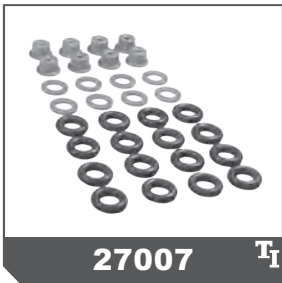

**REPUESTOS PARA INYECTOR TBI**

<b>GENERAL MOTORS</b>		<b>CHEVROLET</b>				
MODELO	AÑO	CIL.	MOTOR	SISTEMA	No. PARTE	
CHEVY	96-03	4	1.4	TBI	27036	
CHEVY	96-03	4	1.6		27036	
CHEVY MONZA	96-03	4	1.6		27036	

**REPUESTO PARA SENSOR DE PEDAL DE ACELERADOR**

<b>AUDI</b>					
MODELO	AÑO	CIL.	MOTOR	SISTEMA	No. PARTE
A3 TURBO	00-04	4	1.8	MPFI	8700
A4 TURBO	00-06	4	1.8		8700

<b>SEAT</b>					
MODELO	AÑO	CIL.	MOTOR	SISTEMA	No. PARTE
CORDOBA	03-06	4	2.0	MPFI	8700
IBIZA	03-15	4	2.0		8700

<b>VOLKSWAGEN</b>					
MODELO	AÑO	CIL.	MOTOR	SISTEMA	No. PARTE
BEETLE	99-05	4	2.0	MPFI	8700
BEETLE TURBO	99-05	4	1.8		8700
GOLF A4	00-05	4	2.0		8700
GOLF A4 GTI TURBO	00-05	4	1.8		8700
JETTA A4	00-10	4	2.0		8700
JETTA A4 CLASICO	10-15	4	2.0		8700
JETTA A4 TURBO	00-05	4	1.8		8700

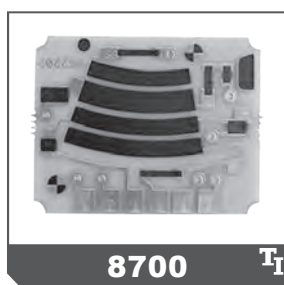

<b>FORD</b>					
MODELO	AÑO	CIL.	MOTOR	SISTEMA	No. PARTE
CONTOUR	98-00	4	2.0	MPFI	8650
CONTOUR	98-00	6	2.5		8650
ESCORT	98-01	4	2.0		8650
EXCURSION	01-04	10	6.8		8650
EXPEDITION	97-02	8	4.6		8650
EXPEDITION	97-02	8	5.4		8650
EXPLORER	01-02	6	4.0		8650
F-150	98-04	6	4.2		8650
F-150	98-04	8	4.6		8650
F-250	98-99	8	4.6		8650
F-350 SUPER DUTY	99-04	8	5.4		8650
FOCUS	00-04	4	2.0		8650
RANGER	98-00	6	3.0		8650
WINDSTAR	98-98	6	3.8		8650

<b>FORD</b>		<b>LINCOLN</b>			
MODELO	AÑO	CIL.	MOTOR	SISTEMA	No. PARTE
NAVIGATOR	98-02	8	5.4	MPFI	8650
TOWN CAR	97-98	8	4.6		8650

<b>FORD</b>		<b>MERCURY</b>			
MODELO	AÑO	CIL.	MOTOR	SISTEMA	No. PARTE
GRAND MARQUIS	97-04	8	4.6	MPFI	8650
MYSTIQUE	98-00	4	2.0		8650
MYSTIQUE	98-00	6	2.5		8650





**SU FUNCIÓN:**

Sirve para diagnosticar si existe detonación en el motor; esta información es enviada al módulo de control (ECM) para corregir el tiempo de encendido.

**SÍNTOMAS DE FALLA:**

El vehículo tarda en funcionar, jaloneo, alto consumo de combustible o genera código de falla.

**MANTENIMIENTO/SERVICIO:**

Revisar conexiones del sensor y cable, cambiar si es necesario.

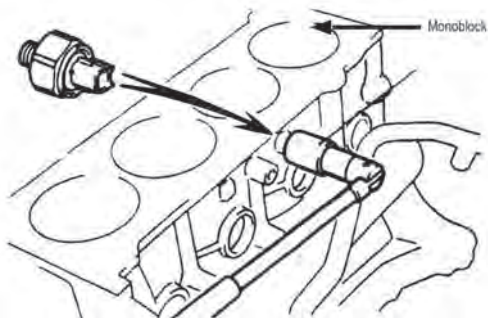

ACURA					
MODELO	AÑO	CIL.	MOTOR	SISTEMA	No. PARTE
RDX TURBO	07-12	4	2.3	MPFI	29238
TSX	09-10	4	2.4		29241

AUDI					
MODELO	AÑO	CIL.	MOTOR	SISTEMA	No. PARTE
A3 QUATTRO	06-08	6	3.2	MPFI	29202
A3 QUATTRO TURBO CONECTOR VERDE	09-16	4	2.0		29214
A3 TURBO CONECTOR VERDE	08-12	4	1.4		29214
A3 TURBO CONECTOR VERDE	08-12	4	1.4		29214
A3 TURBO CONECTOR VERDE	08-12	4	1.8		29214
A3 TURBO CONECTOR VERDE	08-12	4	1.8		29214
A3 TURBO CONECTOR VERDE	06-13	4	2.0		29214
A4 CONECTOR NEGRO	07-07	6	3.2		29202
A4 CONECTOR VERDE	06-07	6	3.2		29214
A4 QUATTRO CONECTOR VERDE	05-12	6	3.2		29214
A4 QUATTRO TURBO	98-00	4	1.8		29001
A4 QUATTRO TURBO	05-09	4	2.0		29202
A4 QUATTRO VR6	98-99	6	2.8		29001
A4 TURBO	97-00	4	1.8		29001
A4 TURBO	05-08	6	2.0		29202
A4 TURBO CONECTOR VERDE	10-14	4	2.0		29214
A4 VR6	96-99	6	2.8		29001
A5 QUATTRO CONECTOR VERDE	12-12	6	3.0		29214
A5 QUATTRO CONECTOR VERDE	08-10	6	3.2		29214
A5 QUATTRO TURBO CONECTOR VERDE	10-14	4	2.0		29214
A5 TURBO CONECTOR VERDE	10-14	4	2.0		29214
A6	99-99	6	2.8		29001
A6 CONECTOR VERDE	07-09	6	3.2		29214
A6 QUATTRO CONECTOR VERDE	09-14	6	3.0		29214
A6 QUATTRO CONECTOR VERDE	05-08	6	3.2		29214
A6 QUATTRO TURBO CONECTOR VERDE	13-14	4	2.0		29214
A6 QUATTRO VR6	99-99	6	2.8		29001
A6 TURBO CONECTOR VERDE	13-14	4	2.0		29214
A7 QUATTRO TURBO CONECTOR VERDE	12-15	6	3.0		29214
A8 QUATTRO	12-14	12	6.3		29202
A8 QUATTRO TURBO	13-14	8	4.0		29202
A8 QUATTRO TURBO CONECTOR VERDE	13-14	6	3.0		29214
Q5 CONECTOR VERDE	10-12	6	3.2		29214
Q5 TURBO CONECTOR VERDE	11-14	4	2.0	29214	
Q5 TURBO CONECTOR VERDE	13-14	6	3.0	29214	
Q7	07-10	6	3.6	29202	

AUDI					
MODELO	AÑO	CIL.	MOTOR	SISTEMA	No. PARTE
Q7 TURBO CONECTOR VERDE	11-14	6	3.0	MPFI	29214
R8 CONECTOR VERDE	10-14	10	5.2		29214
S4 TURBO CONECTOR VERDE	10-16	6	3.0		29214
S5 TURBO CONECTOR VERDE	10-14	6	3.0		29214
S6 TURBO	13-14	8	4.0		29202
S7	13-14	8	4.0		29202
S8 TURBO	13-14	8	4.0		29202
SQ5 TURBO CONECTOR VERDE	14-17	6	3.0		29214
TT QUATTRO	04-09	6	3.2		29202
TT QUATTRO	04-09	6	3.2		29202
TT QUATTRO TURBO	01-06	4	1.8		29202
TT QUATTRO TURBO CONECTOR GRIS	12-12	5	2.5		29215
TT QUATTRO TURBO CONECTOR VERDE	09-14	4	2.0		29214
TT TURBO	01-06	4	1.8		29202
TT TURBO CONECTOR VERDE	08-09	4	2.0		29214

CHRYSLER					
MODELO	AÑO	CIL.	MOTOR	SISTEMA	No. PARTE
200	12-16	4	2.4	MPFI	29204
300	12-14	8	5.7		29204
300 SRT-8	12-14	8	6.4		29204
300C	05-10	8	5.7		29204
300C SRT-8	06-08	8	6.1		29204
300M	99-04	6	3.5		29220
ASPEN	07-09	8	5.7		29204
CONCORDE	02-02	6	3.5		29220
PACIFICA	07-07	6	3.8		29204
PACIFICA	04-06	6	3.5		29220
PACIFICA	07-08	6	4.0		29220
PT CRUISER	01-02	4	2.4		29066
PT CRUISER	03-10	4	2.4		29204
TOWN & COUNTRY	04-07	6	3.8		29204
TOWN & COUNTRY	08-10	6	4.0		29220
VOYAGER	06-06	6	3.3		29204

CHRYSLER DODGE					
MODELO	AÑO	CIL.	MOTOR	SISTEMA	No. PARTE
ATTITUDE	12-14	4	1.6	MPFI	29237
ATTITUDE DERECHO	06-08	4	1.6		29212
ATTITUDE IZQUIERDO	06-08	4	1.6		29211
AVENGER	08-14	4	2.4		29204
AVENGER	09-10	6	3.5		29220
CALIBER	07-09	4	1.8		29204
CALIBER	07-09	4	2.0		29204
CALIBER	07-12	4	2.4		29204
CHALLENGER R/T	09-14	8	5.7		29204
CHALLENGER SRT-8	08-10	8	6.1		29204
CHALLENGER SRT-8	11-14	8	6.4		29204
CHARGER	06-10	6	3.5		29220
CHARGER R/T	06-14	8	5.7		29204
CHARGER SRT-8	07-10	8	6.1		29204
CHARGER SRT-8	12-14	8	6.4		29204
DAKOTA	07-11	6	3.7		29220
DAKOTA	07-07	8	4.7		29220
DART	13-14	4	2.0		29204
DART	13-15	4	2.4		29204
DURANGO	04-15	8	5.7		29204
H100 VAN	12-14	4	2.4		29230
i10	12-14	4	1.1		29226
INTREPID	98-01	6	3.2		29220
INTREPID	00-01	6	3.5		29220
JOURNEY	09-17	4	2.4		29204
JOURNEY R/T	09-10	6	3.5		29220
NEON	95-02	4	2.0	29066	
NEON	03-05	4	2.0	29204	
NEON SRT-4	04-05	4	2.4	29204	

CONTINÚA»

CHRYSLER		DODGE				
MODELO	AÑO	CIL.	MOTOR	SISTEMA	No. PARTE	
NITRO	07-12	6	3.7	MPFI	29220	
NITRO R/T	07-09	6	4.0		29220	
RAM 1500	11-13	6	3.7		29220	
RAM 2500	11-17	8	5.7		29204	
STRATUS	01-02	4	2.4		29066	
STRATUS	03-06	4	2.4		29204	
VERNA	04-06	4	1.5		29212	
VERNA	04-06	4	1.6		29212	
VIPER	06-06	10	8.3		29204	

CHRYSLER		JEEP				
MODELO	AÑO	CIL.	MOTOR	SISTEMA	No. PARTE	
CHEROKEE	14-17	4	2.4	MPFI	29204	
COMMANDER	06-10	8	5.7		29204	
COMPASS	07-17	4	2.4		29204	
GRAND CHEROKEE	05-17	8	5.7		29204	
GRAND CHEROKEE	07-10	6	3.7		29220	
GRAND CHEROKEE	08-09	8	4.7		29220	
GRAND CHEROKEE SRT-8	06-10	8	6.1		29204	
GRAND CHEROKEE SRT-8	12-17	8	6.4		29204	
LIBERTY	05-05	6	3.7		29204	
LIBERTY	07-13	6	3.7		29220	
PATRIOT	07-17	4	2.4		29204	
WRANGLER	07-11	6	3.8		29204	

FIAT						
MODELO	AÑO	CIL.	MOTOR	SISTEMA	No. PARTE	
500	09-15	4	1.4	MPFI	29223	
GRANDE PUNTO	07-09	4	1.4		29222	

FORD						
MODELO	AÑO	CIL.	MOTOR	SISTEMA	No. PARTE	
ECONOLINE E-150	97-98	6	4.2	MPFI	29049	
ECONOLINE E-150	04-14	8	4.6		29234	
ECONOLINE E-250	97-98	6	4.2		29049	
ECONOLINE E-250	00-04	8	5.4		29234	
ECONOLINE E-350	00-03	8	5.4		29234	
ESCAPE	05-08	4	2.3		29217	
ESCAPE	09-17	4	2.5		29217	
ESCAPE	01-07	6	3.0		29221	
ESCAPE TURBO	14-17	4	2.0		29217	
EXCURSION	00-01	10	6.8		29234	
EXCURSION	04-05	10	6.8		29234	
EXPEDITION	99-04	8	4.6		29234	
EXPEDITION	99-04	8	5.4		29234	
EXPLORER	99-10	6	4.0		29216	
F-150	98-98	6	4.2		29049	
F-150	97-97	8	4.6		29049	
F-150	05-08	6	4.2		29224	
F-150	01-01	8	4.2		29234	
F-150	99-02	8	4.6		29234	
F-150	04-10	8	4.6		29234	
F-250	99-01	8	4.6		29234	
F-350 SUPER DUTY	99-04	8	5.4		29234	
F-450 SUPER DUTY	99-04	10	6.8		29234	
F-550 SUPER DUTY	99-04	10	6.8		29234	
FIESTA	04-09	4	1.6		29224	
FOCUS	02-16	4	2.0		29217	
FOCUS ST	08-10	5	2.5		29217	
FREESTAR	04-07	6	4.2		29224	
FUSION	06-09	4	2.3		29217	
FUSION	10-17	4	2.5		29217	
FUSION TURBO	14-16	4	2.0		29217	
LOBO	02-03	8	5.4		29234	
LOBO	05-06	8	5.4		29234	
MUSTANG	96-99	8	4.6	29049		

FORD						
MODELO	AÑO	CIL.	MOTOR	SISTEMA	No. PARTE	
MUSTANG	05-10	6	4.0	MPFI	29216	
MUSTANG SHELBY GT	10-10	8	5.4		29224	
RANGER	01-12	4	2.3		29217	
THUNDERBIRD SC	93-95	6	3.8		29059	

FORD		LINCOLN				
MODELO	AÑO	CIL.	MOTOR	SISTEMA	No. PARTE	
MKZ TURBO	13-17	4	2.0	MPFI	29217	
NAVIGATOR	99-04	8	5.4		29234	
TOWN CAR	04-07	8	4.6		29234	

FORD		MERCURY				
MODELO	AÑO	CIL.	MOTOR	SISTEMA	No. PARTE	
MARINER	05-07	6	3.0	MPFI	29221	
SABLE	00-05	6	3.0		29224	

GENERAL MOTORS		BUICK				
MODELO	AÑO	CIL.	MOTOR	SISTEMA	No. PARTE	
CENTURY	87-89	6	2.8	MPFI	29015	
ENCLAVE	10-15	6	3.6		29227	
LACROSSE	10-16	6	3.6		29227	
REGAL	96-96	6	3.8		29026	
REGAL	95-95	6	3.8		29032	
VERANO	14-16	4	2.4		29227	

GENERAL MOTORS		CADILLAC				
MODELO	AÑO	CIL.	MOTOR	SISTEMA	No. PARTE	
CTS	12-13	8	6.2	MPFI	29225	
CTS	09-15	6	3.6		29227	
CTS	10-13	6	3.0		29227	
DEVILLE	93-95	8	4.9		29015	
ESCALADE	02-06	8	6.0		29205	
ESCALADE	02-05	8	5.3		29205	
ESCALADE	07-13	8	6.2		29225	
ESCALADE ESV	03-06	8	6.0		29205	
ESCALADE ESV	07-13	8	6.2		29225	
ESCALADE EXT	03-06	8	6.0		29205	
ESCALADE EXT	07-13	8	6.2		29225	
SRX	10-11	6	3.0		29227	
SRX	12-15	6	3.6		29227	
STS	07-10	8	4.6		29225	
STS	09-11	6	3.6		29227	

GENERAL MOTORS		CHEVROLET				
MODELO	AÑO	CIL.	MOTOR	SISTEMA	No. PARTE	
ASTRA	01-02	4	2.2	MPFI	29203	
AVALANCHE	02-06	8	5.3		29205	
AVALANCHE	07-13	8	5.3		29225	
AVEO	08-17	4	1.6		29208	
BEAT	18-18	4	1.2		29219	
BLAZER	96-00	6	4.3		29036	
BLAZER NEVADA	91-94	6	3.1		29014	
C2500	91-95	8	5.7		29019	
C3500	94-95	8	5.7		29019	
CAMARO	96-97	8	5.7		29014	
CAMARO	98-02	8	5.7		29205	
CAMARO	10-14	8	6.2		29225	
CAMARO	10-15	6	3.6		29227	
CAPTIVA SPORT	08-08	4	2.4		29203	
CAPTIVA SPORT	09-10	6	3.6		29227	
CAPTIVA SPORT	11-13	4	2.4		29227	
CAPTIVA SPORT	11-15	6	3.0		29227	
CAVALIER	90-94	6	2.8		29015	
CAVALIER	96-04	4	2.2		29027	
CAVALIER	02-04	4	2.2		29203	
CAVALIER Z24	91-94	6	3.1		29015	

GENERAL MOTORS CHEVROLET					
MODELO	AÑO	CIL.	MOTOR	SISTEMA	No. PARTE
CAVALIER Z24	96-98	4	2.4		29027
CELEBRITY	87-89	6	2.8		29015
CHEVY	04-12	4	1.6		29236
CHEYENNE	10-13	8	5.3		29225
CHEYENNE CUSTOM	92-99	8	5.7		29019
COLORADO	07-12	4	2.9		29225
COLORADO	07-12	5	3.7		29225
CORSA	02-04	4	1.4		29236
CORSA	02-08	4	1.8		29236
CORVETTE	91-91	8	5.7		29019
CORVETTE	98-04	8	5.7		29205
CORVETTE	05-07	8	6.0		29225
CORVETTE	08-13	8	6.2		29225
CRUZE	10-15	4	1.8		29229
EQUINOX	05-08	6	3.4		29225
EXPRESS 1500	96-00	6	4.3		29036
EXPRESS 1500	03-07	8	5.3		29205
EXPRESS 1500	08-13	8	5.3		29225
EXPRESS 3500	03-07	8	6.0		29205
EXPRESS 3500	08-13	8	6.0		29225
HHR	06-08	4	2.4		29203
IMPALA	00-03	6	3.4		29028
LUMINA	96-96	6	3.4		29028
LUV	98-04	4	2.2		29236
MALIBU	97-98	4	2.4		29027
MALIBU	97-03	6	3.1		29028
MALIBU	99-99	4	2.4		29203
MALIBU	04-07	4	2.2		29203
MALIBU	08-09	4	2.4		29203
MALIBU	04-07	6	3.5		29225
MALIBU	11-13	4	2.4		29227
MALIBU	09-12	6	3.6		29227
MATIZ	11-15	4	1.0		29219
MERIVA	04-05	4	1.8	MPFI	29236
MICROBUS	92-99	8	5.7		29019
OPTRA	06-06	4	2.0		29208
P30	92-95	8	5.7		29019
S10	96-03	4	2.2		29027
S10 MAXICAB	91-93	6	3.1		29014
SILVERADO 1500	99-00	6	4.3		29036
SILVERADO 2500	00-06	8	5.3		29205
SILVERADO 3500	06-06	8	8.1		29225
SILVERADO 3500 HD	08-13	8	6.0		29225
SONIC	12-17	4	1.6		29229
SONORA	03-05	8	5.3		29205
SPARK CLASSIC	11-17	4	1.2		29219
SUBURBAN	92-99	8	5.7		29019
SUBURBAN	07-13	8	5.3		29225
SUBURBAN 1500	00-06	8	5.3		29205
SUBURBAN 2500	00-05	8	6.0		29205
SUBURBAN 2500	07-13	8	6.0		29225
TAHOE	07-15	8	5.3		29225
TORNADO	04-05	4	1.8		29236
TRAIL BLAZER	03-05	8	5.3		29205
TRAIL BLAZER	06-07	6	4.2		29225
TRAIL BLAZER	06-06	8	5.3		29225
TRAIL BLAZER EXT	03-04	8	5.3		29205
TRAIL BLAZER EXT	06-06	6	4.2		29225
TRAIL BLAZER EXT	05-06	8	5.3		29225
TRAVERSE	09-15	6	3.6		29227
TRAX	13-16	4	1.8		29229
UPLANDER	07-08	6	3.9		29225
UPLANDER	05-06	6	3.5		29225
VECTRA	03-03	4	2.2		29203
VENTURE	97-04	6	3.4		29028

GENERAL MOTORS GMC					
MODELO	AÑO	CIL.	MOTOR	SISTEMA	No. PARTE
ACADIA	09-15	6	3.6		29227
SIERRA	10-10	8	5.3		29225
SIERRA 1500	07-07	8	5.3		29205
SIERRA 1500	08-13	8	5.3		29225
SIERRA 1500 DENALI	08-13	8	6.2		29225
SIERRA DENALI	10-10	8	6.2	MPFI	29225
TERRAIN	13-16	6	3.6		29227
TERRAIN	11-12	6	3.0		29227
YUKON	07-09	8	5.3		29225
YUKON	07-13	8	6.2		29225

GENERAL MOTORS OLDSMOBILE					
MODELO	AÑO	CIL.	MOTOR	SISTEMA	No. PARTE
CUTLASS	87-88	6	2.8		29015
CUTLASS	96-96	6	3.1	MPFI	29028
SILHOUETTE	90-94	6	3.1		29014

GENERAL MOTORS HUMMER					
MODELO	AÑO	CIL.	MOTOR	SISTEMA	No. PARTE
H2	05-07	8	6.0		29205
H2	08-09	8	6.2		29225
H3	08-10	8	5.3	MPFI	29225
H3T	09-10	5	3.7		29225
H3T	09-10	8	5.3		29225

GENERAL MOTORS PONTIAC					
MODELO	AÑO	CIL.	MOTOR	SISTEMA	No. PARTE
AZTEK	01-05	6	3.4		29028
BONNEVILLE	96-99	6	3.8		29026
G5	07-09	4	2.2		29203
G5 GT	07-08	4	2.4		29203
G6	05-09	6	3.5		29225
G6	09-09	6	3.6		29227
GRAND AM	99-04	6	3.4		29028
GRAND PRIX	97-01	6	3.1		29028
GRAND PRIX SC	97-01	6	3.8	MPFI	29026
MATIZ	04-10	4	1.0		29208
MONTANA	05-06	6	3.5		29225
MONTANA	06-07	6	3.9		29225
SOLSTICE	06-09	4	2.4		29203
SUNFIRE	96-02	4	2.2		29027
SUNFIRE	97-98	4	2.4		29027
SUNFIRE	02-05	4	2.2		29203
SUNFIRE	99-02	4	2.4		29203
TORRENT	06-09	6	3.4		29225

HONDA					
MODELO	AÑO	CIL.	MOTOR	SISTEMA	No. PARTE
ACCORD	03-07	4	2.4		29238
ACCORD	05-05	6	3.0		29238
ACCORD	08-12	4	2.4		29241
CIVIC	97-00	4	1.6	MPFI	29068
CIVIC	01-05	4	1.7		29233
CR-V	02-09	4	2.4		29238
CR-V	10-12	4	2.4		29241

KIA					
MODELO	AÑO	CIL.	MOTOR	SISTEMA	No. PARTE
RIO	16-17	4	1.6	MPFI	29237

MAZDA					
MODELO	AÑO	CIL.	MOTOR	SISTEMA	No. PARTE
3	06-13	4	2.0		29217
3	06-09	4	2.3	MPFI	29217
3	10-13	4	2.5		29217
3 SPORT	12-12	4	2.0		29217

CONTINÚA»

# SENSORES DE DETONACIÓN

MAZDA					
MODELO	AÑO	CIL.	MOTOR	SISTEMA	No. PARTE
5	06-10	4	2.3	MPFI	29217
5	12-15	4	2.5		29217
6	06-08	4	2.3		29217
6	09-13	4	2.5		29217
CX-7	10-12	4	2.5		29217
MX-5 MIATA	06-15	4	2.0		29217

MERCEDES BENZ					
MODELO	AÑO	CIL.	MOTOR	SISTEMA	No. PARTE
E320	00-00	6	3.2	MPFI	29218

NISSAN			INFINITI		
MODELO	AÑO	CIL.	MOTOR	SISTEMA	No. PARTE
I30	98-01	6	3.0	MPFI	29062
Q45	96-96	8	4.5		29062
Q45	01-01	8	4.1		29062
Q45	04-06	8	4.5		29232

NISSAN					
MODELO	AÑO	CIL.	MOTOR	SISTEMA	No. PARTE
240SX	98-98	4	2.4	MPFI	29062
240SX	93-93	4	2.4		29062
300ZX	91-96	6	3.0		29062
350Z	03-06	6	3.5		29232
ALTIMA	96-01	4	2.4		29062
ALTIMA	03-06	4	2.5		29231
ALTIMA	04-06	6	3.5		29231
ALTIMA	02-03	4	2.5		29239
ARMADA	05-09	8	5.6		29231
D21	97-08	4	2.4		29062
FRONTIER	01-04	6	3.3		29209
FRONTIER	06-08	4	2.4		29231
FRONTIER	08-10	6	4.0		29231
LUCINO GSE	96-00	4	1.6		29062
LUCINO GSR	96-00	4	2.0		29062
MAXIMA	95-99	6	3.0		29062
MAXIMA	03-08	6	3.5		29231
MICRA	05-07	4	1.4		29231
MURANO	04-07	6	3.5		29232
NP300	09-15	4	2.4		29062
NP300 TDI	09-15	4	2.5		29231
PATHFINDER	97-00	6	3.3		29062
PATHFINDER	99-00	6	3.3		29209
PATHFINDER	05-10	6	4.0		29231
PATHFINDER	03-04	6	3.5		29232
PATHFINDER ARMADA	04-04	8	5.6		29231
PLATINA	02-10	4	1.6		29069
QUEST	97-98	6	3.0		29062
QUEST	99-02	6	3.3		29209
QUEST	04-09	6	3.5		29231
SENTRA	00-00	4	1.6	29062	
SENTRA	98-01	4	2.0	29062	
SENTRA	03-06	4	1.8	29231	
SENTRA	07-12	4	2.0	29231	
SENTRA SE-R	03-06	4	2.5	29231	
SENTRA SE-R	02-03	4	2.5	29239	
TITAN	04-10	8	5.6	29231	
VERSA	12-12	4	1.6	29231	
XTERRA	00-04	6	3.3	29209	
XTERRA	05-07	6	4.0	29231	
X-TRAIL	04-07	4	2.5	29231	

PORSCHE					
MODELO	AÑO	CIL.	MOTOR	SISTEMA	No. PARTE
CAYENNE	08-13	6	3.6	MPFI	29202
CAYENNE	04-06	6	3.2		29202

RENAULT					
MODELO	AÑO	CIL.	MOTOR	SISTEMA	No. PARTE
CLIO	02-10	4	1.6	MPFI	29069

SEAT					
MODELO	AÑO	CIL.	MOTOR	SISTEMA	No. PARTE
IBIZA	04-06	4	1.6	MPFI	29202
IBIZA	09-15	4	2.0		29202
LEON	08-11	4	1.4		29202
LEON FR	07-11	4	2.0		29202
LEON TURBO	04-06	4	1.8		29202
LEON TURBO CONECTOR VERDE	10-11	4	1.8		29214

TOYOTA					
MODELO	AÑO	CIL.	MOTOR	SISTEMA	No. PARTE
4RUNNER	06-09	6	4.0	MPFI	29218
4RUNNER	05-09	8	4.7		29218
CAMRY	02-06	6	3.0		29210
CAMRY	03-11	4	2.4		29218
CAMRY	10-16	4	2.5		29218
CAMRY	07-16	6	3.5		29218
COROLLA	03-16	4	1.8		29218
COROLLA XRS	09-13	4	2.4		29218
FJ CRUISER	08-14	6	4.0		29218
HIACE	06-16	4	2.7		29218
HIGHLANDER	08-16	6	3.5		29218
LAND CRUISER	06-07	8	4.7		29218
LAND CRUISER	08-11	8	5.7		29218
LAND CRUISER	13-16	8	5.7		29218
MATRIX	03-10	4	1.8		29218
MATRIX	09-10	4	2.4		29218
PRIUS HIBRIDO	10-14	4	1.8		29218
RAV4	04-08	4	2.4		29218
RAV4	09-17	4	2.5		29218
RAV4	09-12	6	3.5		29218
SEQUOIA	10-12	8	4.6		29218
SEQUOIA	08-12	8	4.7		29218
SEQUOIA	08-16	8	5.7		29218
SIENNA	04-06	6	3.3		29218
SIENNA	07-16	6	3.5		29218
SOLARA	05-06	6	3.3		29218
TACOMA	06-15	6	4.0		29218
TUNDRA	07-07	6	4.0		29218
TUNDRA	07-09	8	4.7	29218	
TUNDRA	11-13	8	5.7	29218	
YARIS	06-17	4	1.5	29218	

VOLKSWAGEN					
MODELO	AÑO	CIL.	MOTOR	SISTEMA	No. PARTE
BEETLE	98-00	4	2.0	MPFI	29200
BEETLE	02-05	4	2.0		29202
BEETLE CONECTOR GRIS	06-12	5	2.5		29215
BEETLE TURBO	99-05	4	1.8		29202
BEETLE TURBO CONECTOR VERDE	12-13	4	2.0		29214
BORA CONECTOR GRIS BANCO 2	06-10	5	2.5		29215
BORA CONECTOR VERDE BANCO 1	06-10	5	2.5		29214
CROSSFOX	07-09	4	1.6		29201
EOS TURBO CONECTOR VERDE	10-10	4	2.0		29214
GOL	09-17	4	1.6		29202
GOLF A2	90-92	4	1.8		29001
GOLF A3	93-94	4	1.8		29001
GOLF A3	93-99	4	2.0		29001
GOLF A3	93-98	4	2.0		29207
GOLF A3 VR6	95-98	6	2.8		29001
GOLF A4	01-06	4	2.0		29202
GOLF A4 GTI	00-05	4	1.8		29202
GOLF A4 R32	04-04	6	3.2		29202
GOLF A6 GTI CONECTOR VERDE	07-13	4	2.0		29214

VOLKSWAGEN					
MODELO	AÑO	CIL.	MOTOR	SISTEMA	No. PARTE
JETTA A2 FBU	90-92	4	1.8	MPFI	29001
JETTA A3	93-99	4	1.8		29001
JETTA A3	93-99	4	2.0		29207
JETTA A3 VR6	95-99	6	2.8		29001
JETTA A4	99-10	4	2.0		29202
JETTA A4 CLASICO	10-15	4	2.0		29202
JETTA A4 TURBO	00-05	4	1.8		29202
JETTA A4 VR6	02-04	6	2.8		29202
JETTA A6	13-16	4	2.0		29202
JETTA A6 GLI	12-16	4	2.0		29202
PASSAT	12-14	6	3.6		29202
PASSAT	06-08	6	3.6		29202
PASSAT CONECTOR GRIS	12-12	5	2.5		29215
PASSAT CONECTOR VERDE	09-09	6	3.6		29214
PASSAT CC	10-10	6	3.6		29202
PASSAT CC TURBO CONECTOR VERDE	10-10	4	2.0		29214
PASSAT TURBO	98-00	4	1.8		29001
PASSAT TURBO CONECTOR VERDE	06-10	4	2.0		29214
PASSAT VR6	98-99	6	2.8		29001
PASSAT VR6	93-97	6	2.8		29207
POINTER	98-09	4	1.8		29201
POINTER GTI	00-03	4	2.0		29201
POINTER PICK UP	99-03	4	1.8		29201
POLO	03-07	4	2.0		29201
ROUTAN	09-10	6	3.8		29204
TIGUAN TURBO CONECTOR VERDE	09-17	4	2.0		29214
TOUAREG	04-06	6	3.2		29202
TOUAREG	08-14	6	3.6		29202
VAN	03-09	4	1.8		29201
VENTO	14-17	4	1.6		29202

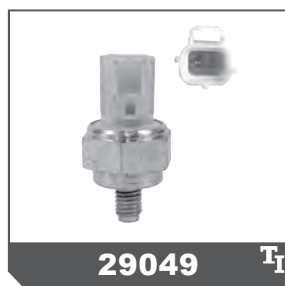
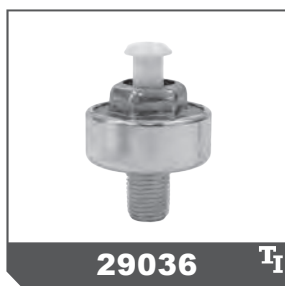
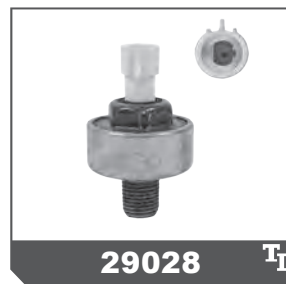
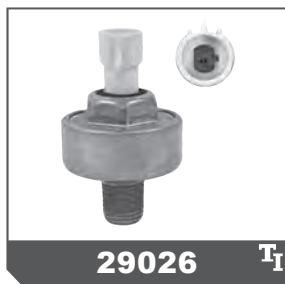
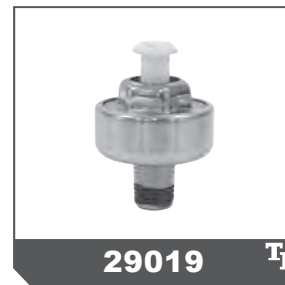
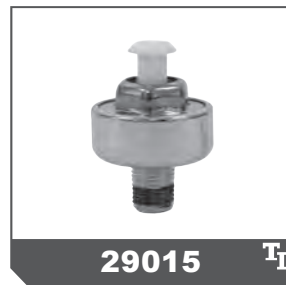
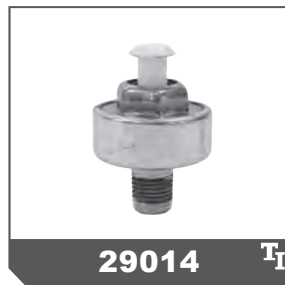
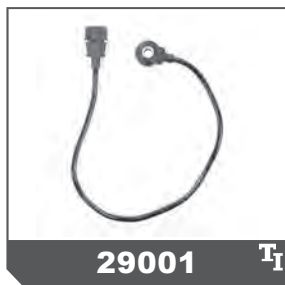



# SENSORES DE DETONACIÓN

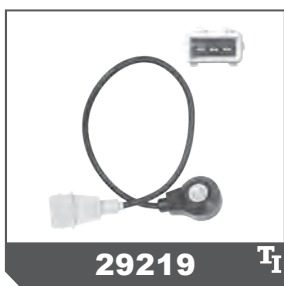
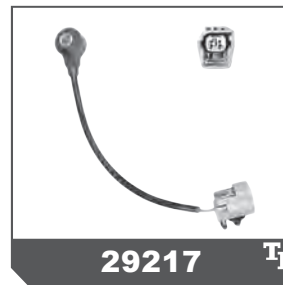
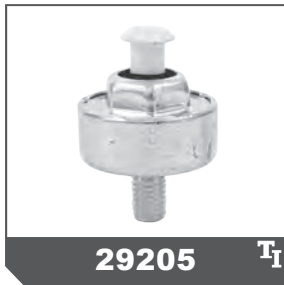



**SENSORES DE DETONACIÓN**

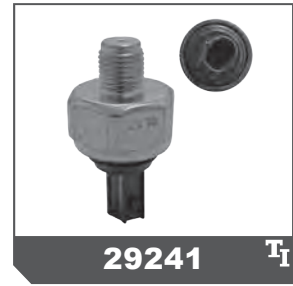
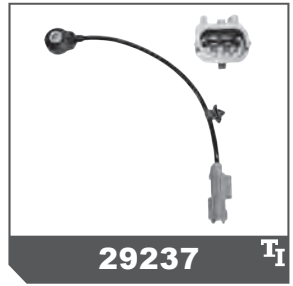
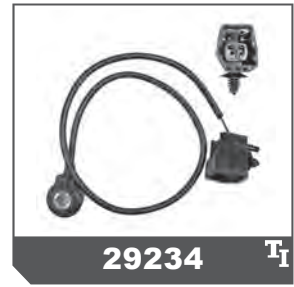
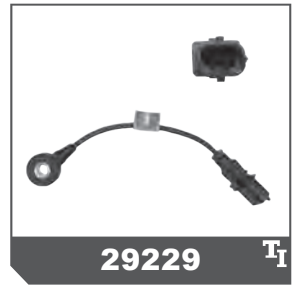

**SU FUNCIÓN:**

Medir la cantidad de aire que entra al motor en gramos por segundo.

**SÍNTOMAS DE FALLA:**

Dificultad para arrancar, humo negro, jaloneo, sobrecalentamiento del convertidor catalítico, bajo rendimiento.

**MANTENIMIENTO/SERVICIO:**

Checar si hay códigos de falla. Dar limpieza con líquido dieléctrico. Revisar que no existan fugas de vacío en el sistema de admisión.

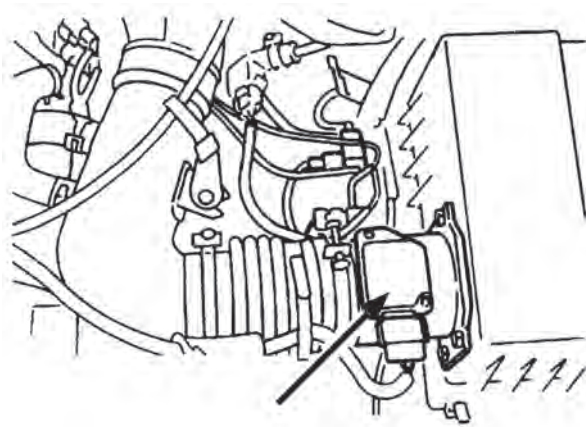

ACURA						
MODELO	AÑO	CIL.	MOTOR	SISTEMA	No. PARTE	
ILX	13-15	4	2.0		20953	
MDX	07-13	6	3.7		20953	
MDX	14-16	6	3.5		20953	
RDX	13-17	6	3.5		20953	
RDX TURBO	07-12	4	2.3		20953	
RL	09-10	6	3.7	MPFI	20953	
RLX	14-15	6	3.5		20953	
TL	09-13	6	3.5		20953	
TL	09-13	6	3.7		20953	
TSX	10-13	6	3.5		20953	
ZDX	10-11	6	3.7		20953	

AUDI						
MODELO	AÑO	CIL.	MOTOR	SISTEMA	No. PARTE	
A3 TURBO	09-13	4	2.0		20949	
A3 TURBO	05-08	4	2.0		20950	
A3 TURBO	98-98	4	1.8	MPFI	20991	
A4 TURBO	97-00	4	1.8		20991	
TT TURBO	07-13	4	2.0		20950	

FORD						
MODELO	AÑO	CIL.	MOTOR	SISTEMA	No. PARTE	
AEROSTAR	91-95	6	4.0		20988	
AEROSTAR	91-91	6	3.0		20992	
CONTOUR	95-99	4	2.0		20989	
ECONOLINE E-150	01-03	6	4.2		20966	
ECONOLINE E-150	04-14	8	4.6		20971	
ECONOLINE E-150	04-07	8	5.4		20971	
ECONOLINE E-150	99-00	6	4.2		20979	
ECONOLINE E-150 CLUB WAGON	04-05	8	4.6		20971	
ECONOLINE E-150 CLUB WAGON	04-05	8	5.4	MPFI	20971	
ECONOLINE E-250	99-00	6	4.2		20979	
ECONOLINE E-350	03-03	8	5.4		20966	
ECONOLINE E-350	97-98	8	5.4		20984	
ECONOLINE E-350 CLUB WAGON	04-05	8	5.4		20971	
EDGE	07-15	6	3.5		20971	
ESCAPE	05-08	4	2.3		20971	
ESCAPE	09-12	4	2.5		20971	
ESCAPE	08-12	6	3.0		20971	

FORD						
MODELO	AÑO	CIL.	MOTOR	SISTEMA	No. PARTE	
ESCAPE	01-07	6	3.0		20979	
ESCORT	97-01	4	2.0		20990	
ESCORT	96-96	4	1.9		20990	
EXCURSION	01-05	10	6.8		20966	
EXPEDITION	12-14	8	5.4		20951	
EXPEDITION	05-11	8	5.4		20971	
EXPEDITION	97-04	8	4.6		20984	
EXPEDITION	97-08	8	5.4		20984	
EXPLORER	13-15	6	3.5		20951	
EXPLORER	11-12	6	3.5		20971	
EXPLORER	04-10	8	4.6		20971	
EXPLORER	04-10	6	4.0		20971	
EXPLORER	99-03	6	4.0		20979	
EXPLORER	00-01	8	5.0		20979	
EXPLORER	91-94	6	4.0		20988	
EXPLORER SPORT TRAC	07-10	8	4.6		20971	
F-150	10-14	6	3.7		20951	
F-150	11-14	8	5.0		20951	
F-150	05-09	6	4.2		20971	
F-150	10-10	8	4.6	MPFI	20971	
F-150	97-99	8	4.6		20984	
F-150	94-94	6	3.8		20985	
F-150	92-93	6	3.8		20996	
F-250	05-09	8	4.6		20971	
F-250	97-98	8	4.6		20984	
F-250	96-97	8	5.0		20984	
F-250	96-97	8	5.8		20984	
F-350	05-09	8	5.4		20971	
F-350	96-98	8	5.0		20984	
F-350	96-97	8	5.8		20984	
F-350 SUPER DUTY	11-15	8	6.2		20951	
F-350 SUPER DUTY	05-10	8	5.4		20971	
F-450 SUPER DUTY	11-14	10	6.8		20951	
F-450 SUPER DUTY	02-04	10	6.8		20966	
F-450 SUPER DUTY	05-10	10	6.8		20971	
F-550 SUPER DUTY	11-15	10	6.8		20951	
F-550 SUPER DUTY	02-04	10	6.8		20966	
F-550 SUPER DUTY	05-10	10	6.8		20971	
FIESTA	11-13	4	1.6		20971	

CONTINÚA»

<b>FORD</b>					
MODELO	AÑO	CIL.	MOTOR	SISTEMA	No. PARTE
FIVE HUNDRED	05-07	6	3.0		20971
FOCUS	12-15	4	2.0		20952
FOCUS	08-11	4	2.0		20971
FUSION	13-15	4	2.5		20951
FUSION	06-09	4	2.3		20971
FUSION	10-12	4	2.5		20971
FUSION	06-12	6	3.0		20971
FUSION SPORT	10-12	6	3.5		20971
FUSION TURBO	14-16	4	2.0		20952
GHIA	93-94	6	3.0		20992
MONDEO	04-05	6	2.5		20971
MUSTANG	11-14	6	3.7		20951
MUSTANG	11-14	8	5.0		20951
MUSTANG	03-04	8	4.6		20966
MUSTANG	05-10	8	4.6	MPFI	20971
MUSTANG	05-10	6	4.0		20971
MUSTANG	96-98	8	4.6		20984
MUSTANG	94-95	8	5.0		20997
MUSTANG SHELBY GT	11-12	8	5.4		20951
RANGER	04-12	4	2.3		20971
RANGER	13-13	4	2.5		20971
RANGER	96-00	6	3.0		20990
RANGER	96-97	4	2.3		20990
TAURUS	89-91	6	3.8		20996
THUNDERBIRD	95-95	8	4.6		20985
THUNDERBIRD	91-93	8	5.0		20996
THUNDERBIRD SC	91-95	6	3.8		20987
WINDSTAR	95-95	6	3.8		20973
WINDSTAR	00-03	6	3.8		20979

<b>FORD</b>					
<b>LINCOLN</b>					
MODELO	AÑO	CIL.	MOTOR	SISTEMA	No. PARTE
LS	04-05	6	3.0		20971
MARK VIII	96-98	8	4.6		20984
MKS	13-14	6	3.7		20951
MKS	09-12	6	3.7		20971
MKX	07-10	6	3.5		20971
MKX	11-15	6	3.7		20971
MKZ	07-12	6	3.5		20971
MKZ TURBO	13-16	4	2.0		20952
NAVIGATOR	12-14	8	5.4		20951
NAVIGATOR	05-11	8	5.4		20971
NAVIGATOR	98-98	8	5.4		20984
TOWN CAR	05-07	8	4.6		20971
TOWN CAR	91-92	8	4.6		20988
ZEPHYR	06-06	6	3.0		20971

<b>FORD</b>					
<b>MERCURY</b>					
MODELO	AÑO	CIL.	MOTOR	SISTEMA	No. PARTE
COUGAR XR7	91-94	6	3.8		20987
GRAND MARQUIS	92-92	8	4.6		20988
GRAND MARQUIS	92-94	8	4.6		20997
MARINER	09-11	6	3.0		20971
MARINER	05-07	6	3.0		20979
MILAN	07-08	6	3.0	MPFI	20971
MYSTIQUE	95-95	4	2.0		20989
SABLE	00-03	6	3.0		20979
SABLE	96-99	6	3.0		20990
SABLE	94-95	6	3.8		20996
TOPAZ	92-94	4	2.3		20995

<b>GENERAL MOTORS</b>					
<b>BUICK</b>					
MODELO	AÑO	CIL.	MOTOR	SISTEMA	No. PARTE
CENTURY	87-89	6	2.8	MPFI	20002-X

<b>GENERAL MOTORS</b>					
<b>CADILLAC</b>					
MODELO	AÑO	CIL.	MOTOR	SISTEMA	No. PARTE
CTS	12-14	8	6.2		20960
CTS	11-11	6	3.0		20960
DEVILLE	00-04	8	4.6		20978
ESCALADE	09-14	8	6.2		20960
ESCALADE	02-05	8	5.3		20978
ESCALADE	02-06	8	6.0	MPFI	20978
ESCALADE ESV	09-12	8	6.2		20960
ESCALADE EXT	09-12	8	6.2		20960
SEVILLE	00-04	8	4.6		20978
SRX	10-11	6	3.0		20959
STS	06-10	8	4.6		20959

<b>GENERAL MOTORS</b>					
<b>CHEVROLET</b>					
MODELO	AÑO	CIL.	MOTOR	SISTEMA	No. PARTE
ASTRA	00-03	4	1.8		20974
AVALANCHE	08-08	8	5.3		20957
AVALANCHE	09-10	8	5.3		20960
AVALANCHE	07-07	8	5.3		20963
AVALANCHE	02-06	8	5.3		20978
BLAZER	96-01	6	4.3		20980
CAMARO	10-15	8	6.2		20959
CAMARO	95-02	8	5.7		20980
CAPTIVA SPORT	08-11	4	2.4		20959
CAPTIVA SPORT	08-10	6	3.6		20963
CAPTIVA SPORT	11-11	6	3.0		20963
CELEBRITY	87-89	6	2.8		20002-X
COLORADO	07-11	4	2.9		20959
COLORADO	07-11	5	3.7		20959
COLORADO	04-06	4	2.8		20977
COLORADO	04-06	5	3.5		20977
CORVETTE	08-13	8	6.2		20959
CORVETTE	06-07	8	6.0		20978
CORVETTE	01-04	8	5.7		20978
CORVETTE	94-00	8	5.7		20980
EQUINOX	05-08	6	3.4		20963
EXPRESS 1500	03-06	6	4.3		20968
EXPRESS 1500	03-11	8	5.3		20968
EXPRESS 1500	96-97	6	4.3		20980
EXPRESS 2500	96-97	8	5.7		20980
EXPRESS 3500	03-15	8	6.0		20968
EXPRESS 3500	96-97	8	5.7	MPFI	20980
HHR	06-09	4	2.4		20959
IMPALA	00-03	6	3.4		20980
LUMINA	96-96	6	3.4		20980
MALIBU	08-11	4	2.4		20959
MALIBU	08-12	6	3.6		20963
MALIBU	04-07	4	2.2		20977
MALIBU	07-07	6	3.5		20977
MALIBU	97-03	6	3.1		20980
SILVERADO 1500	09-14	6	4.3		20960
SILVERADO 1500	99-06	6	4.3		20978
SILVERADO 2500	07-08	8	5.3		20957
SILVERADO 2500	99-06	8	5.3		20978
SILVERADO 3500	01-07	8	6.0		20978
SILVERADO 3500	04-06	8	5.7		20978
SILVERADO 3500	01-06	8	8.1		20978
SILVERADO 3500 HD	08-08	8	6.0		20957
SILVERADO 3500 HD	09-15	8	6.0		20960
SONIC	12-17	4	1.6		20958
SUBURBAN	09-14	8	5.3		20960
SUBURBAN 1500	07-08	8	5.3		20957
SUBURBAN 1500	00-06	8	5.3		20978
SUBURBAN 2500	09-13	8	6.0		20960
SUBURBAN 2500	00-06	8	6.0		20978
TAHOE	07-08	8	5.3		20957
TAHOE	09-14	8	5.3		20960

CONTINÚA»

GENERAL MOTORS		CHEVROLET			
MODELO	AÑO	CIL.	MOTOR	SISTEMA	No. PARTE
TORNADO	09-11	4	1.8	MPFI	20959
TRAIL BLAZER	06-07	6	4.2		20959
TRAIL BLAZER	06-06	8	5.3		20978
TRAIL BLAZER EXT	05-06	6	4.2		20978
TRAIL BLAZER EXT	05-06	8	5.3		20978
TRAX	13-16	4	1.8		20958
UPLANDER	05-06	6	3.5		20963
UPLANDER	07-09	6	3.9		20963
VENTURE	97-04	6	3.4		20980

GENERAL MOTORS		GMC			
MODELO	AÑO	CIL.	MOTOR	SISTEMA	No. PARTE
ACADIA	07-08	6	3.6	MPFI	20963
CANYON	07-11	5	3.7		20959
SIERRA 1500	08-08	8	5.3		20957
SIERRA 1500	09-13	8	5.3		20960
SIERRA 1500	07-07	8	5.3		20978
SIERRA 1500 DENALI	09-13	8	6.2		20960
TERRAIN	11-11	6	3.0		20959
YUKON	07-08	8	5.3		20957
YUKON	09-09	8	5.3		20960
YUKON	09-15	8	6.2		20960

GENERAL MOTORS		HUMMER			
MODELO	AÑO	CIL.	MOTOR	SISTEMA	No. PARTE
H2	03-07	8	6.0	MPFI	20978
H3	08-10	8	5.3		20959
H3T	09-10	5	3.7		20959
H3T	09-10	8	5.3		20959

GENERAL MOTORS		OLDSMOBILE			
MODELO	AÑO	CIL.	MOTOR	SISTEMA	No. PARTE
CUTLASS	87-88	6	2.8	MPFI	20002-X

GENERAL MOTORS		PONTIAC			
MODELO	AÑO	CIL.	MOTOR	SISTEMA	No. PARTE
AZTEK	01-05	6	3.4	MPFI	20980
FIREBIRD TRANS AM	94-01	8	5.7		20980
G5	07-09	4	2.2		20959
G5 GT	07-08	4	2.4		20959
G6	07-07	6	3.6		20963
G6	08-09	6	3.5		20963
GRAND AM	99-04	6	3.4		20980
GRAND PRIX	97-01	6	3.1		20980
MONTANA	06-09	6	3.9		20963
SOLSTICE	06-09	4	2.4		20959
TORRENT	06-09	6	3.4		20963

HONDA					
MODELO	AÑO	CIL.	MOTOR	SISTEMA	No. PARTE
ACCORD	03-07	4	2.4	MPFI	20953
ACCORD	02-07	6	3.0		20953
ACCORD	08-15	6	3.5		20953
ACCORD	13-15	4	2.4		20953
CIVIC	06-15	4	1.8		20953
CIVIC HIBRIDO	06-11	4	1.3		20953
CIVIC HIBRIDO	12-13	4	1.5		20953
CR-Z HIBRIDO	13-15	4	1.5		20953
FIT	09-17	4	1.5		20953
ODYSSEY	07-15	6	3.5		20953
PILOT	09-15	6	3.5		20953
RIDGELINE	09-14	6	3.5		20953

JAGUAR					
MODELO	AÑO	CIL.	MOTOR	SISTEMA	No. PARTE
S-TYPE	02-08	6	3.0	MPFI	20948

JAGUAR					
MODELO	AÑO	CIL.	MOTOR	SISTEMA	No. PARTE
S-TYPE	03-08	8	4.2	MPFI	20948
XF	09-10	8	4.2		20948
XF	10-10	8	5.0		20948
XJ8	05-08	8	4.2		20948
XK8	03-04	8	4.2		20948
X-TYPE	02-04	6	2.5		20948
X-TYPE	02-07	6	3.0		20948

LAND ROVER					
MODELO	AÑO	CIL.	MOTOR	SISTEMA	No. PARTE
LR2	08-12	6	3.2	MPFI	20948
LR3	06-09	8	4.4		20948
RANGE ROVER	06-09	8	4.2		20948
RANGE ROVER	06-09	8	4.4		20948
RANGE ROVER SPORT	06-09	8	4.4		20948

MAZDA					
MODELO	AÑO	CIL.	MOTOR	SISTEMA	No. PARTE
2	12-15	4	1.5	MPFI	20948
3	06-13	4	2.0		20948
3	10-13	4	2.5		20948
3	06-09	4	2.3		20948
5	06-10	4	2.3		20948
5	12-15	4	2.5		20948
6	06-08	6	3.0		20948
6	06-08	4	2.3		20948
6	09-13	4	2.5		20948
6	09-13	6	3.7		20971
CX-7	10-12	4	2.5		20948
CX-9	07-07	6	3.5		20971
CX-9	08-15	6	3.7		20971
MX-5 MIATA	06-15	4	2.0		20948

MITSUBISHI					
MODELO	AÑO	CIL.	MOTOR	SISTEMA	No. PARTE
ECLIPSE	06-12	6	3.8	MPFI	20955
ENDEAVOR	04-11	6	3.8		20955
GALANT	04-09	4	2.4		20955
GALANT	04-09	6	3.8		20955
LANCER	08-15	4	2.0		20955
LANCER GTS	09-15	4	2.4		20955
LANCER RALLIART	05-06	4	2.4		20955
MONTERO SPORT	09-13	6	3.5		20955
OUTLANDER	08-13	4	2.4		20955
OUTLANDER	07-13	6	3.0		20955

NISSAN		INFINITI			
MODELO	AÑO	CIL.	MOTOR	SISTEMA	No. PARTE
FX35	12-12	6	3.5	MPFI	20965
FX37	13-13	6	3.7		20965
G37	12-13	6	3.7		20965
I30 C/RESISTENCIA	00-01	6	3.0		20967
I35 C/RESISTENCIA	03-03	6	3.5		20967
Q45	05-06	8	4.5		20965
QX80	14-16	8	5.6		20965

NISSAN					
MODELO	AÑO	CIL.	MOTOR	SISTEMA	No. PARTE
350Z	03-08	6	3.5	MPFI	20965
370Z	09-16	6	3.7		20965
ALMERA C/RESISTENCIA	01-05	4	1.8		20967
ALTIMA	07-16	6	3.5		20965
ALTIMA	07-12	4	2.5		20965
ALTIMA C/RESISTENCIA	04-06	4	2.5		20967
ALTIMA C/RESISTENCIA	04-06	6	3.5		20967
ARMADA	05-15	8	5.6		20965

**SENSORES DE FLUJO DE MASA DE AIRE**

NISSAN					
MODELO	AÑO	CIL.	MOTOR	SISTEMA	No. PARTE
D21	94-08	4	2.4		20962
FRONTIER	06-14	4	2.4		20965
FRONTIER	08-17	6	4.0		20965
MARCH	12-18	4	1.6		20965
MAXIMA	07-15	6	3.5		20965
MAXIMA C/RESISTENCIA	00-01	6	3.0		20967
MAXIMA C/RESISTENCIA	02-06	6	3.5		20967
MURANO	04-14	6	3.5		20965
NP300	09-15	4	2.4		20956
NV2500	13-15	6	4.0		20965
PATHFINDER	05-12	6	4.0		20965
PATHFINDER	13-14	6	3.5		20965
QUEST	04-08	6	3.5		20965
ROGUE	08-14	4	2.5		20965
SENTRA	07-12	4	2.0		20965
SENTRA	96-99	4	1.6		20993
SENTRA	96-99	4	2.0	MPFI	20993
SENTRA S/RESISTENCIA	01-06	4	1.8		20976
SENTRA S/RESISTENCIA	00-00	4	1.6		20976
SENTRA S/RESISTENCIA	00-01	4	2.0		20976
SENTRA SE-R	07-12	4	2.5		20965
SENTRA SE-R C/RESISTENCIA	04-06	4	2.5		20967
TIIDA	07-18	4	1.8		20965
TIIDA	13-18	4	1.6		20965
TITAN	04-15	8	5.6		20965
TSURU III	98-16	4	1.6		20962
TSURU III GSR 2000	94-96	4	2.0		20999
URVAN	08-13	4	2.5		20965
VERSA	12-18	4	1.6		20965
XTERRA	00-04	4	2.4		20956
XTERRA	05-07	6	4.0		20965
X-TRAIL	04-14	4	2.5		20965
X-TRAIL C/RESISTENCIA	02-03	4	2.5		20967

RENAULT					
MODELO	AÑO	CIL.	MOTOR	SISTEMA	No. PARTE
SCALA	11-13	4	1.6	MPFI	20965

TOYOTA					
MODELO	AÑO	CIL.	MOTOR	SISTEMA	No. PARTE
4RUNNER	06-09	6	4.0		20954
4RUNNER	05-09	8	4.7		20954
CAMRY	02-06	6	3.0		20948
CAMRY	02-06	4	2.4		20948
COROLLA	03-08	4	1.8		20948
HIACE	06-16	4	2.7		20954
LAND CRUISER	05-07	8	4.7		20954
LAND CRUISER	08-11	8	5.7		20954
LAND CRUISER	13-16	8	5.7	MPFI	20954
MATRIX	03-08	4	1.8		20948
MR2 SPYDER	05-05	4	1.8		20948
PRIUS HIBRIDO	10-16	4	1.8		20954
RAV4	04-05	4	2.4		20948
SIENNA	04-06	6	3.3		20948
SOLARA	05-06	6	3.3		20948
TACOMA	06-15	6	4.0		20948
YARIS	06-17	4	1.5		20948

VOLKSWAGEN					
MODELO	AÑO	CIL.	MOTOR	SISTEMA	No. PARTE
BEETLE	98-03	4	2.0		20983
BEETLE TURBO	12-13	4	2.0		20949
BEETLE TURBO	99-03	4	1.8		20983
BORA	06-10	5	2.5		20947
BORA GLI TURBO	06-10	4	2.0		20950
BORA TDI	08-10	4	1.9		20947

VOLKSWAGEN					
MODELO	AÑO	CIL.	MOTOR	SISTEMA	No. PARTE
EOS TURBO	10-10	4	2.0		20949
EUROVAN TDI	06-09	4	1.9		20947
GOLF A3	93-98	4	2.0		20991
GOLF A3 VR6	95-98	6	2.8		20975
GOLF A4	00-07	4	2.0		20983
GOLF A4 GTI TURBO	00-05	4	1.8		20983
GOLF A5 GTI TURBO	07-09	4	2.0		20950
GOLF A6 GTI TURBO	10-13	4	2.0		20950
JETTA A3	93-99	4	2.0		20991
JETTA A3 VR6	96-98	6	2.8		20975
JETTA A3 VR6	95-95	6	2.8	MPFI	20981
JETTA A4	99-03	4	2.0		20983
JETTA A4 TDI	06-11	4	1.9		20947
JETTA A4 TURBO	99-03	4	1.8		20983
JETTA A6 GLI TURBO	12-16	4	2.0		20949
PASSAT CC TURBO	09-10	4	2.0		20949
PASSAT TURBO	06-10	4	2.0		20950
PASSAT VR6	95-97	6	2.8		20975
SHARAN TURBO	02-04	4	1.8		20983
TIGUAN TURBO	09-16	4	2.0		20949
TOUAREG	04-07	8	4.2		20983

VOLVO					
MODELO	AÑO	CIL.	MOTOR	SISTEMA	No. PARTE
S40	07-10	5	2.4		20948
S80	08-11	6	3.0		20948
S80	14-14	6	3.0		20948
S80	08-11	6	3.2	MPFI	20948
S80	07-10	8	4.4		20948
V70	01-07	5	2.4		20948
XC90	08-11	6	3.2		20948

# SENSORES DE FLUJO DE MASA DE AIRE

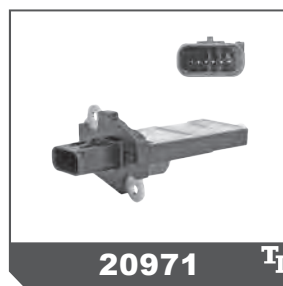
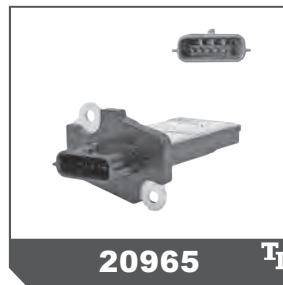
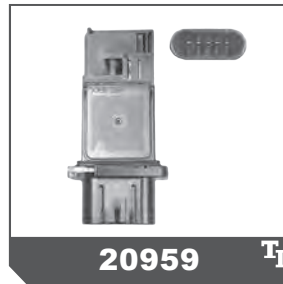



**SENSORES DE FLUJO DE MASA DE AIRE**

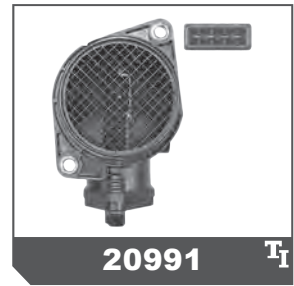
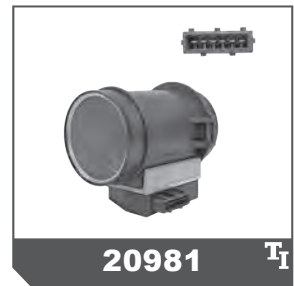
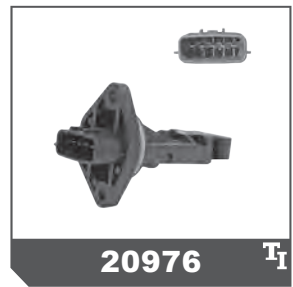

**SU FUNCIÓN:**

Convierte la presión de los gases de escape en una señal de voltaje análoga; ésta es enviada a la computadora para controlar el flujo de la EGR y el tiempo de ignición.

**SÍNTOMAS DE FALLA:**

Sobrecalentamiento, pérdida de potencia, marcha mínima inestable.

**MANTENIMIENTO/SERVICIO:**

Checar cuando la EGR no funcione correctamente durante la verificación de emisiones de contaminantes, cuando las emisiones de contaminantes resulten altas o cuando haya códigos de falla.

**LOCALIZACIÓN:**

En el motor o en la pared de fuego.

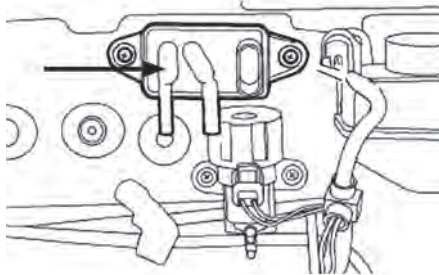

FORD					
MODELO	AÑO	CIL.	MOTOR	SISTEMA	No. PARTE
CONTOUR	98-00	6	2.5	MPFI	10898
CONTOUR	98-00	6	2.5		10904
CONTOUR	95-97	4	2.0		10906
CONTOUR	96-97	6	2.5		10906
CONTOUR	95-95	6	2.5		10908
ECONOLINE E-150	96-96	6	4.9		10898
ECONOLINE E-150	97-03	6	4.2		10898
ECONOLINE E-150	04-04	8	4.6		10899
ECONOLINE E-150	01-02	6	4.2		10899
ECONOLINE E-150	95-95	6	4.9		10904
ECONOLINE E-250	97-03	6	4.2		10898
ECONOLINE E-250	00-00	8	5.4		10899
ECONOLINE E-250	01-02	6	4.2		10899
ECONOLINE E-350	97-00	8	5.4		10898
ESCAPE	03-08	6	3.0		10898
ESCAPE	01-02	6	3.0		10899
ESCORT	99-00	4	2.0		10898
ESCORT	94-95	4	1.9		10900
ESCORT	97-97	4	2.0		10906
ESCORT	94-96	4	1.9		10907
EXCURSION	01-05	10	6.8		10898
EXPEDITION	97-04	8	4.6		10898
EXPEDITION	97-04	8	5.4		10898
EXPEDITION	01-04	8	4.6		10899
EXPLORER	96-01	6	4.0		10898
EXPLORER	01-03	6	4.0		10899
EXPLORER	02-03	8	4.6		10899
EXPLORER	93-95	6	4.0		10906
EXPLORER	93-95	6	4.0		10909
F-150	97-04	6	4.2		10898
F-150	96-96	6	4.9	10898	
F-150	97-04	8	4.6	10898	
F-150	97-04	6	4.2	10899	
F-150	97-04	8	4.6	10899	
F-150	92-94	6	3.8	10900	

FORD					
MODELO	AÑO	CIL.	MOTOR	SISTEMA	No. PARTE
F-150	99-99	6	4.2	MPFI	10904
F-150	97-98	6	4.2		10906
F-150	95-95	6	4.9		10906
F-250	97-99	8	4.6		10898
F-250	96-96	8	5.0		10898
F-250	96-97	8	5.8		10898
F-250	97-99	8	4.6		10899
F-250	98-99	8	4.6		10904
F-250	95-95	8	5.8		10906
F-350	96-97	8	5.8		10898
F-350	95-95	8	5.8		10906
F-350 SUPER DUTY	99-03	8	5.4		10898
F-450 SUPER DUTY	99-04	10	6.8		10898
F-550 SUPER DUTY	99-04	10	6.8		10898
FOCUS	00-04	4	2.0		10898
FOCUS	00-04	4	2.0		10899
FOCUS STATION WAGON	00-04	4	2.0		10899
FOCUS ZX3	00-04	4	2.0		10899
GHIA	91-91	4	2.3		10900
GHIA	92-94	6	3.0		10900
KA	01-08	4	1.6		10898
LOBO	01-03	8	5.4		10898
MUSTANG	96-04	8	4.6		10898
MUSTANG	96-97	8	4.6		10906
RANGER	98-08	6	3.0		10898
RANGER	94-97	4	2.3		10906
RANGER	96-97	6	3.0		10906
TAURUS	91-91	6	3.8		10900
THUNDERBIRD	95-96	8	4.6		10898
THUNDERBIRD	96-96	6	3.8		10898
THUNDERBIRD	89-95	6	3.8	10900	
WINDSTAR	01-02	6	3.8	10899	
WINDSTAR	98-03	6	3.8	10904	
WINDSTAR	95-97	6	3.8	10906	

FORD		LINCOLN			
MODELO	AÑO	CIL.	MOTOR	SISTEMA	No. PARTE
AVIATOR	05-05	8	4.6	MPFI	10898
LS	00-02	8	3.9		10898
MARK VIII	96-98	8	4.6		10898
NAVIGATOR	98-04	8	5.4		10898
TOWN CAR	95-00	8	4.6		10898
TOWN CAR	01-02	8	4.6		10899
TOWN CAR	91-94	8	4.6		10906
TOWN CAR	91-94	8	4.6		10909

FORD		MERCURY			
MODELO	AÑO	CIL.	MOTOR	SISTEMA	No. PARTE
COUGAR XR7	90-95	6	3.8	MPFI	10900
GRAND MARQUIS	98-00	8	4.6		10898
GRAND MARQUIS	01-02	8	4.6		10899
GRAND MARQUIS	92-94	8	4.6		10900
GRAND MARQUIS	95-97	8	4.6		10906
MARINER	05-08	6	3.0		10898
MYSTIQUE	95-95	4	2.0		10898
MYSTIQUE	96-00	6	2.5		10898
MYSTIQUE	95-95	4	2.0		10906
MYSTIQUE	96-98	6	2.5		10906
MYSTIQUE	95-95	6	2.5		10908
SABLE	96-04	6	3.0		10898
SABLE	00-02	6	3.0		10899
SABLE	94-95	6	3.8		10900
SABLE	96-97	6	3.0		10906
TOPAZ	91-94	4	2.3		10900

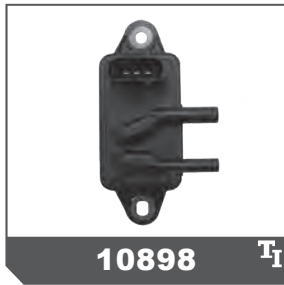
**SENSORES DE INFORMACIÓN DE PRESIÓN DE VÁLVULA EGR**

**10898** <sup>TI</sup>

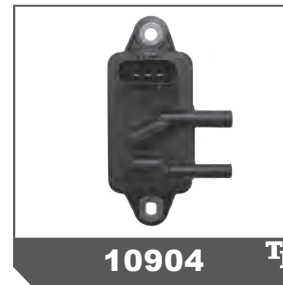
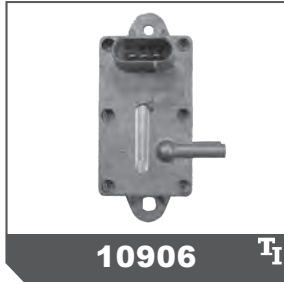
**10899** <sup>TI</sup>

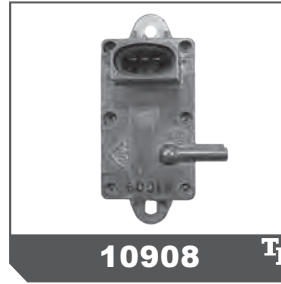
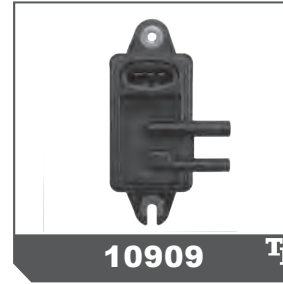
**10900** <sup>TI</sup>

**10904** <sup>TI</sup>

**10906** <sup>TI</sup>

**10907** <sup>TI</sup>

**10908** <sup>TI</sup>

**10909** <sup>TI</sup>
**SENSORES DE POSICIÓN DEL ACELERADOR**
**SU FUNCIÓN:**

Indicar la posición del acelerador a la computadora para ajustar el tiempo de encendido y la cantidad de gasolina.

**SÍNTOMAS DE FALLA:**

Jalaneo, vibración. El vehículo tarda en responder. Se enciende la luz de "chechar motor".

**MANTENIMIENTO/SERVICIO:**

Inspeccionar su operación y ajuste del sensor a los voltajes requeridos cuando sea necesario. Cheque si hay corrosión en los conectores.

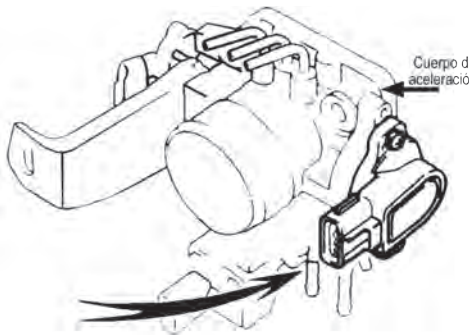
**CHRYSLER**

MODELO	AÑO	CIL.	MOTOR	SISTEMA	No. PARTE
NEW YORKER K	85-85	4	2.2	MPFI	14102
NEW YORKER LH	94-96	6	3.5		14107
NEW YORKER LH	97-97	6	3.5		14112
NEW YORKER TURBO	91-94	4	2.5		14107
PACIFICA	04-06	6	3.5		14972
PHANTOM TURBO	87-88	4	2.2		14101
PHANTOM TURBO	90-94	4	2.5		14101
PT CRUISER	01-10	4	2.4		14989
TOWN & COUNTRY	94-97	6	3.8		14107
TOWN & COUNTRY	93-93	6	3.3		14107
TOWN & COUNTRY	01-07	6	3.8		14972
TOWN & COUNTRY	98-00	6	3.8		14988
VOYAGER	94-97	6	3.3	14107	
VOYAGER	01-05	6	3.3	14972	
VOYAGER	98-00	6	3.3	14988	

**CHRYSLER**
**DODGE**

MODELO	AÑO	CIL.	MOTOR	SISTEMA	No. PARTE	
ATOS	05-12	4	1.1	MPFI	14960	
ATOS	01-04	4	1.0		14984	
ATTITUDE	06-11	4	1.6		14974	
ATTITUDE	06-11	4	1.4		14980	
D-250	91-91	8	5.9		TBI	14104
D-350	91-91	8	5.9			14104
DAKOTA	07-07	8	4.7	MPFI	14098	
DAKOTA	05-06	6	3.7		14979	
DURANGO	98-00	8	5.2		14098	
DURANGO	98-03	8	5.9		14098	
DURANGO	02-07	8	4.7		14098	
H100 CHASIS	03-05	4	2.4		14976	
H100 VAN	12-14	4	2.4		14964	
i10	12-14	4	1.1		14965	
INTREPID	94-94	6	3.5		14107	
INTREPID	96-97	6	3.5		14112	
MAGNUM K	86-88	4	2.2		14101	
MAGNUM K	84-85	4	2.2		14102	
MICROBUS	91-94	8	5.9	TBI	14104	
NEON	95-96	4	2.0		MPFI	14998
NEON	95-05	4	2.0			14999

**CHRYSLER**

MODELO	AÑO	CIL.	MOTOR	SISTEMA	No. PARTE
CIRRUS	96-97	6	2.5	MPFI	14110
CIRRUS	96-97	4	2.4		14112
CIRRUS	00-00	4	2.4		14988
CIRRUS	98-00	6	2.5		14989
CONCORDE	93-95	6	3.5		14107
CONCORDE	96-97	6	3.5		14112
GRAND VOYAGER	91-93	6	3.3		14107
GRAND VOYAGER	94-97	6	3.8		14107
GRAND VOYAGER	98-00	6	3.8		14988
LEBARON K	86-87	4	2.2		14101
LEBARON K / TURBO	84-85	4	2.2		14102
LEBARON TURBO	92-92	4	2.5		14107
NEW YORKER K	86-88	4	2.2	14101	

CONTINÚA»

CHRYSLER		DODGE			
MODELO	AÑO	CIL.	MOTOR	SISTEMA	No. PARTE
NEON SRT-4	04-05	4	2.4		14988
RAM 1500	97-01	6	3.9		14098
RAM 1500	94-96	6	3.9		14106
RAM 1500	02-06	6	3.7		14979
RAM 1500	02-02	6	3.9		14979
RAM 2500	97-02	8	5.9		14098
RAM 2500	94-96	8	5.2		14106
RAM 2500	94-96	8	5.9		14106
RAM 2500	03-03	8	5.7	MPFI	14979
RAM 3500	97-02	8	5.9		14098
RAM 3500	94-96	8	5.9		14106
RAM 4000	97-02	8	5.9		14098
RAM VAN 1500	99-03	6	3.9		14098
RAM VAN 2500	99-03	8	5.2		14098
RAM VAN 3500	99-03	8	5.9		14098
RAMCHARGER	99-01	8	5.2		14098
RAMCHARGER	99-01	8	5.9		14098
RAMCHARGER	91-91	8	5.9	TBI	14104
RAMCHARGER	92-96	8	5.9		14106
SHADOW	91-94	4	2.5		14106
SHADOW GTS	89-90	4	2.2		14101
SHADOW TURBO	91-92	4	2.5		14107
SPIRIT	91-95	4	2.5		14106
SPIRIT R/T	91-94	4	2.5		14107
STRATUS	95-97	4	2.4		14112
STRATUS	01-06	4	2.4	MPFI	14961
STRATUS	96-00	4	2.4		14988
STRATUS	95-96	4	2.0		14998
STRATUS	95-05	4	2.0		14999
VERNA	04-06	4	1.6		14980
VERNA	04-06	4	1.5		14980
VIPER	04-05	10	8.3		14972

CHRYSLER		JEEP			
MODELO	AÑO	CIL.	MOTOR	SISTEMA	No. PARTE
CHEROKEE SPORT	94-94	6	4.0		14106
COMMANDER	06-07	8	4.7		14098
GRAND CHEROKEE	97-98	8	5.2		14098
GRAND CHEROKEE	98-98	8	5.9		14098
GRAND CHEROKEE	99-06	8	4.7		14098
GRAND CHEROKEE	93-96	6	4.0		14106
GRAND CHEROKEE	93-96	8	5.2	MPFI	14106
GRAND CHEROKEE	02-04	6	4.0		14979
GRAND CHEROKEE	05-06	6	3.7		14979
LIBERTY	02-06	6	3.7		14979
WRANGLER	93-95	4	2.5		14106
WRANGLER	02-02	4	2.5		14979
WRANGLER	03-06	4	2.4		14979
WRANGLER	02-06	6	4.0		14979

FIAT					
MODELO	AÑO	CIL.	MOTOR	SISTEMA	No. PARTE
PALIO	04-05	4	1.6	MPFI	14968
PALIO ADVENTURE	04-05	4	1.6		14968

FORD					
MODELO	AÑO	CIL.	MOTOR	SISTEMA	No. PARTE
AEROSTAR	91-93	6	3.0		14022
AEROSTAR	91-95	6	4.0		14037
CONTOUR VIN L	97-00	6	2.5		14042
COURIER	01-12	4	1.6		14981
ECONOLINE E-150	95-95	6	4.9	MPFI	14022
ECONOLINE E-150	97-03	6	4.2		14039
ECONOLINE E-150	04-04	8	4.6		14039
ECONOLINE E-250	97-03	6	4.2		14039
ECONOLINE E-350	97-03	8	5.4		14039

FORD					
MODELO	AÑO	CIL.	MOTOR	SISTEMA	No. PARTE
ECOSPORT	04-07	4	2.0		14983
ESCAPE	01-08	6	3.0		14042
ESCAPE	05-08	4	2.3		14983
ESCORT	94-95	4	1.9		14078
ESCORT	97-01	4	2.0		14092
ESCORT	96-96	4	1.9		14092
EXCURSION	01-05	10	6.8		14039
EXPEDITION	98-04	8	4.6		14039
EXPEDITION	98-04	8	5.4		14039
EXPEDITION	05-14	8	5.4		14977
EXPLORER	93-95	6	4.0		14037
EXPLORER	97-03	6	4.0		14039
EXPLORER	02-03	8	4.6		14039
EXPLORER	04-10	6	4.0		14977
EXPLORER	04-10	8	4.6		14977
EXPLORER SPORT TRAC	07-10	8	4.6		14977
F-150	95-95	6	4.9		14022
F-150	92-93	6	3.8		14028
F-150	97-07	6	4.2		14039
F-150	97-03	8	4.6		14039
F-150	04-06	8	4.6		14977
F-250	97-04	8	4.6		14039
F-250	92-95	8	5.0		14015
F-350	92-97	8	5.0		14015
F-350	98-98	8	5.0		14039
F-350	00-04	8	5.4		14039
F-350	05-09	8	5.4		14977
F-350 SUPER DUTY	99-05	8	5.4		14039
F-350 SUPER DUTY	07-10	8	5.4		14977
F-450 SUPER DUTY	99-04	10	6.8		14039
F-450 SUPER DUTY	05-14	10	6.8		14977
F-450 SUPER DUTY	99-04	10	6.8		14039
F-550 SUPER DUTY	05-14	10	6.8		14977
FIESTA	98-01	4	1.3	MPFI	14981
FOCUS	00-04	4	2.0		14092
FOCUS	00-07	4	2.0		14983
FOCUS ZX3	00-04	4	2.0		14983
FREESTAR	04-07	6	4.2		14042
GHIA	93-94	6	3.0		14031
GHIA	91-91	4	2.3		14032
IKON	01-03	4	1.6		14981
KA	01-08	4	1.6		14981
LOBO	04-06	8	4.6		14039
LOBO	03-06	8	5.4		14039
MICROBUS	92-97	8	5.0		14015
MONDEO	02-04	6	2.5		14042
MONDEO	01-07	4	2.0		14983
MONDEO	04-05	6	3.0		14983
MUSTANG	94-95	8	5.0		14029
MUSTANG	96-04	8	4.6		14039
MUSTANG	05-10	6	4.0		14977
MUSTANG	05-10	8	4.6		14977
MUSTANG SHELBY GT	08-12	8	5.4		14977
RANGER	96-97	4	2.3		14039
RANGER	02-02	6	3.0		14042
RANGER	12-12	4	2.3		14042
RANGER	98-01	6	3.0		14963
RANGER	01-11	4	2.3		14983
TAURUS	88-91	6	3.8		14028
THUNDERBIRD	89-93	6	3.8		14028
THUNDERBIRD	91-93	8	5.0		14029
THUNDERBIRD	95-96	8	4.6		14039
THUNDERBIRD	96-96	6	3.8		14963
THUNDERBIRD SC	91-92	6	3.8		14029
WINDSTAR	96-03	6	3.8		14042
WINDSTAR	95-95	6	3.8		14963

FORD		LINCOLN			
MODELO	AÑO	CIL.	MOTOR	SISTEMA	No. PARTE
AVIATOR	03-05	8	4.6	MPFI	14039
LS	03-06	8	3.9		14977
MARK LT	06-08	8	5.4		14977
NAVIGATOR	98-04	8	5.4		14039
NAVIGATOR	05-14	8	5.4		14977
TOWN CAR	91-94	8	4.6		14035
TOWN CAR	95-04	8	4.6		14039
TOWN CAR	05-07	8	4.6		14977

FORD		MERCURY			
MODELO	AÑO	CIL.	MOTOR	SISTEMA	No. PARTE
COUGAR XR7	90-93	6	3.8	MPFI	14028
GRAND MARQUIS	92-94	8	4.6		14035
GRAND MARQUIS	95-04	8	4.6		14039
MARINER	05-08	6	3.0		14042
MYSTIQUE	97-00	6	2.5		14042
SABLE	94-95	6	3.8		14028
SABLE	96-02	6	3.0		14039
SABLE	96-04	6	3.0		14042
TOPAZ	89-94	4	2.3		14032

GENERAL MOTORS		BUICK			
MODELO	AÑO	CIL.	MOTOR	SISTEMA	No. PARTE
CENTURY	87-89	6	2.8	MPFI	14058
CENTURY	91-95	6	3.1		14060
REGAL	96-96	6	3.8		14093

GENERAL MOTORS		CADILLAC			
MODELO	AÑO	CIL.	MOTOR	SISTEMA	No. PARTE
DEVILLE	00-04	8	4.6	MPFI	14130
ESCALADE	02-06	8	6.0		14095
ESCALADE	07-07	8	6.2		14130
ESCALADE SIN CONTROL DE TRACCIÓN	02-05	8	5.3		14130
SEVILLE	00-04	8	4.6		14095

GENERAL MOTORS		CHEVROLET				
MODELO	AÑO	CIL.	MOTOR	SISTEMA	No. PARTE	
ASTRA	04-06	4	2.0	MPFI	14971	
AVALANCHE	02-02	8	5.3		14130	
AVEO	08-17	4	1.6		14990	
BEAT	18-18	4	1.2		14062	
BLAZER	95-95	6	4.3		14060	
BLAZER	96-01	6	4.3		14130	
BLAZER NEVADA	91-94	6	3.1		TBI	14062
C2500	96-98	8	5.7		MPFI	14130
C3500	94-95	8	5.7		TBI	14062
C3500	96-00	8	5.7			14130
CAMARO	95-97	8	5.7	MPFI	14060	
CAMARO	95-95	6	3.4		14062	
CAMARO	98-02	8	5.7		14130	
CAVALIER	95-97	4	2.2		14062	
CAVALIER	98-02	4	2.2		14130	
CAVALIER Z24	91-94	6	3.1		14060	
CAVALIER Z24	96-97	4	2.4		14095	
CELEBRITY	87-89	6	2.8		14060	
CHEVY	96-03	4	1.6		14990	
CHEVY	09-12	4	1.6		14990	
CHEVY	94-95	4	1.4	14990		
CHEVY	96-03	4	1.6	TBI	14992	
CHEVY	96-03	4	1.4		14992	
CHEVY C2	04-08	4	1.6	MPFI	14990	
CHEVY MONZA	96-03	4	1.6		14990	
CHEVY MONZA	96-03	4	1.6	TBI	14992	
CHEVY PICK UP	99-03	4	1.6	MPFI	14990	
CHEVY WAGON	00-03	4	1.6		14990	
CHEYENNE CUSTOM	92-99	8	5.7	TBI	14062	

GENERAL MOTORS		CHEVROLET				
MODELO	AÑO	CIL.	MOTOR	SISTEMA	No. PARTE	
CORSA	06-08	4	1.8	MPFI	14959	
CORSA	03-05	4	1.8		14990	
CORVETTE	96-96	8	5.7		14060	
EXPRESS 1500	03-06	8	5.3		14095	
EXPRESS 1500	96-06	6	4.3		14130	
EXPRESS 2500	96-02	8	5.7		14130	
EXPRESS 3500	96-02	8	5.7		14130	
EXPRESS 3500	03-07	8	6.0		14130	
IMPALA	00-03	6	3.8		14093	
IMPALA	00-03	6	3.4		14095	
LUMINA	96-96	6	3.4	14095		
LUV	98-05	4	2.2	14072		
MALIBU	97-01	4	2.4	14095		
MALIBU	97-03	6	3.1	14130		
MERIVA	04-05	4	1.8	14990		
MICROBUS	92-99	8	5.7	TBI	14062	
OPTRA	06-10	4	2.0	MPFI	14062	
P30	92-96	8	5.7	TBI	14062	
S10	95-97	4	2.2	MPFI	14062	
S10	98-03	4	2.2		14095	
SILVERADO 1500	99-07	6	4.3		14130	
SILVERADO 2500	99-00	8	5.3		14130	
SILVERADO 3500	01-02	8	6.0		14130	
SONORA	00-02	8	5.7		14130	
SPARK CLASSIC	11-17	4	1.2		14062	
SUBURBAN	92-99	8	5.7		TBI	14062
SUBURBAN 1500	00-03	8	5.3		14130	
SUBURBAN 2500	00-02	8	6.0		14130	
TORNADO	04-05	4	1.8	14072		
TORNADO	06-08	4	1.8	MPFI	14959	
TRACKER	99-04	4	2.0	14975		
TRACKER	02-04	6	2.5	14958		
VENTURE	97-04	6	3.4	14130		

GENERAL MOTORS		OLDSMOBILE			
MODELO	AÑO	CIL.	MOTOR	SISTEMA	No. PARTE
88	92-92	6	3.8	MPFI	14064
88	93-95	6	3.8		14073
CUTLASS	87-88	6	2.8		14058
CUTLASS	95-96	6	3.1	14060	
SILHOUETTE	91-94	6	3.1	TBI	14062
SILHOUETTE	92-92	6	3.8	MPFI	14064
SILHOUETTE	94-95	6	3.8		14073

GENERAL MOTORS		PONTIAC			
MODELO	AÑO	CIL.	MOTOR	SISTEMA	No. PARTE
AZTEK	01-05	6	3.4	MPFI	14130
BONNEVILLE	94-95	6	3.8		14073
BONNEVILLE	95-99	6	3.8		14093
G3	07-09	4	1.6		14990
GRAND AM	99-04	6	3.4		14130
GRAND PRIX	97-01	6	3.1		14095
GRAND PRIX SC	97-01	6	3.8		14093
MATIZ	04-05	4	1.0		14062
MONTANA	05-05	6	3.5		14130
SUNFIRE	95-97	4	2.2		14062
SUNFIRE	97-02	4	2.4	14095	
SUNFIRE	97-98	4	2.2	14095	

MITSUBISHI					
MODELO	AÑO	CIL.	MOTOR	SISTEMA	No. PARTE
ECLIPSE	03-05	6	3.0	MPFI	14960
GALANT	04-04	4	2.4		14960
GALANT	03-03	6	3.0		14960
LANCER	04-07	4	2.0		14973
MONTERO SPORT	03-04	6	3.5		14960



# SENSORES DE POSICIÓN DEL ACELERADOR

NISSAN		INFINITI			
MODELO	AÑO	CIL.	MOTOR	SISTEMA	No. PARTE
I30	98-01	6	3.0	MPFI	14978
I35	03-03	6	3.5		14978
Q45	01-01	8	4.1		14994

RENAULT					
MODELO	AÑO	CIL.	MOTOR	SISTEMA	No. PARTE
CLIO	02-10	4	1.6	MPFI	14982
MEGANE	01-03	4	2.0		14982

NISSAN					
MODELO	AÑO	CIL.	MOTOR	SISTEMA	No. PARTE
240SX	98-98	4	2.4	MPFI	14978
ALMERA	01-05	4	1.8		14994
ALTIMA	96-01	4	2.4		14978
D21	94-96	4	2.4		14993
D21	97-08	4	2.4		14994
FRONTIER	01-04	4	2.4		14978
LUCINO GSR T/A	96-00	4	2.0		14995
LUCINO GSR T/M	96-00	4	2.0		14997
MAXIMA	95-01	6	3.0		14978
NP300	09-15	4	2.4		14994
PATHFINDER	01-03	6	3.5		14978
PLATINA	02-10	4	1.6		14982
QUEST	97-98	6	3.0		14978
QUEST	99-02	6	3.3		14978
SENTRA	01-06	4	1.8		14978
SENTRA	00-01	4	2.0		14978
SENTRA	92-92	4	1.6		14996
SENTRA T/M	99-99	4	2.0		14994
TSUBAME	93-04	4	1.6		14996
TSURU III	98-16	4	1.6		14994
TSURU III	93-97	4	1.6		14996
TSURU III GSR 2000 T/A	94-96	4	2.0		14995
TSURU III GSR 2000 T/M	94-96	4	2.0		14997
URVAN	00-06	4	2.4		14994
XTERRA	00-04	4	2.4		14978

TOYOTA					
MODELO	AÑO	CIL.	MOTOR	SISTEMA	No. PARTE
COROLLA	03-05	4	1.8	MPFI	14973
MATRIX	03-06	4	1.8		14973
MR2 SPYDER	05-05	4	1.8		14973
RAV4	04-05	4	2.4		14973

VOLKSWAGEN					
MODELO	AÑO	CIL.	MOTOR	SISTEMA	No. PARTE
COMBI	93-98	4	1.8	MPFI	14991
DERBY	95-97	4	1.8	TBI	14969
DERBY	95-09	4	1.8	MPFI	14991
DERBY	01-03	4	2.0		14991
GOLF A3	93-98	4	1.8	TBI	14969
GOLF A3	93-97	4	2.0	MPFI	14987
GOLF A3	93-98	4	1.8		14991
GOLF A3 VR6 T/M	95-95	6	2.8	14987	
JETTA A3	93-98	4	1.8	TBI	14969
JETTA A3	93-99	4	1.8	MPFI	14991
JETTA A3 T/M	93-97	4	2.0		14987
JETTA A3 VR6 T/M	95-95	6	2.8		14987
PASSAT VR6 T/M	95-95	6	2.8		14987
POINTER	98-09	4	1.8	MPFI	14985
POINTER GTI	00-03	4	2.0		14985
POINTER PICK UP	99-07	4	1.8		14985
SEDAN	93-04	4	1.6	14991	
VAN	03-09	4	1.8	14985	

PEUGEOT					
MODELO	AÑO	CIL.	MOTOR	SISTEMA	No. PARTE
206	00-05	4	1.4	MPFI	14970

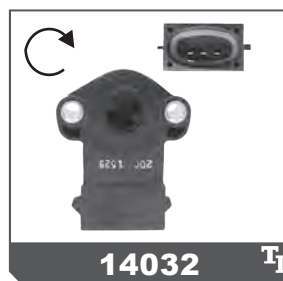
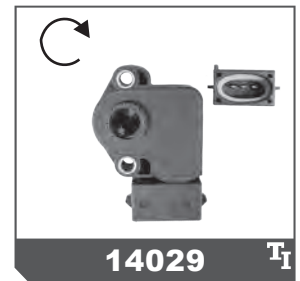
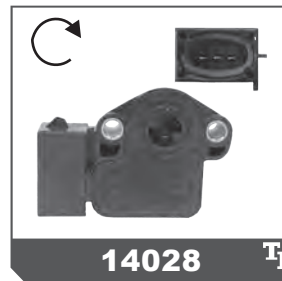
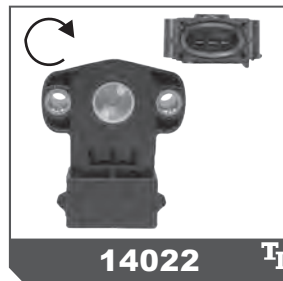
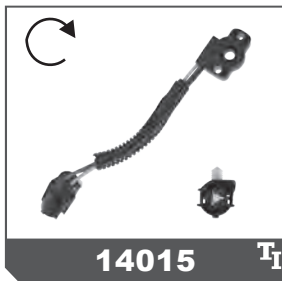



**SENSORES DE POSICIÓN DEL ACELERADOR**

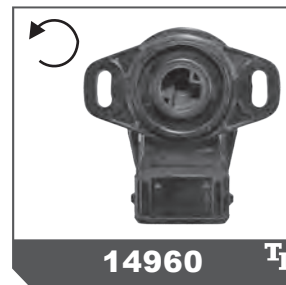
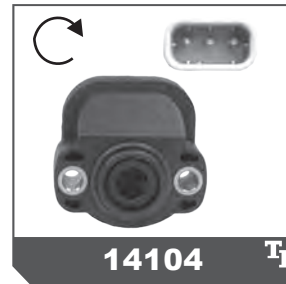
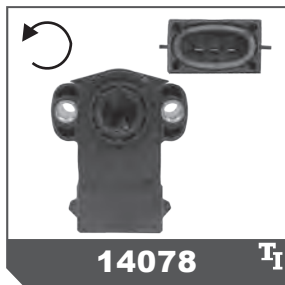
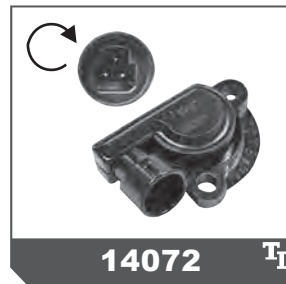
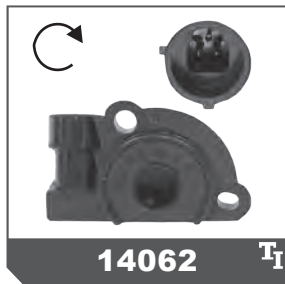

NUEVO

# SENSORES DE POSICIÓN DEL ACELERADOR

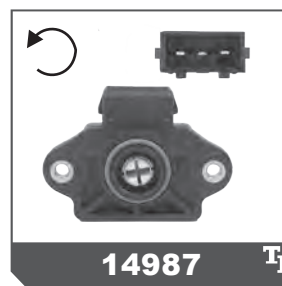
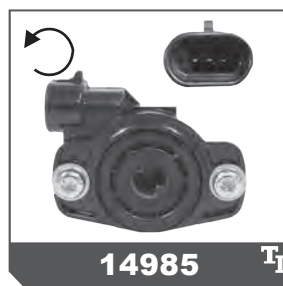
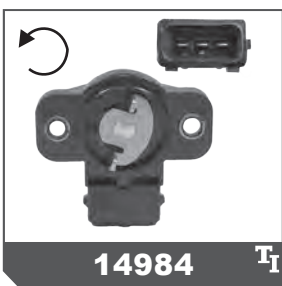
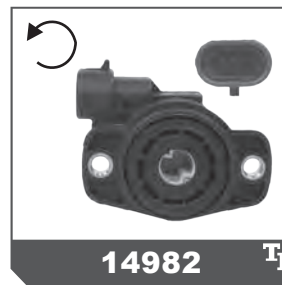
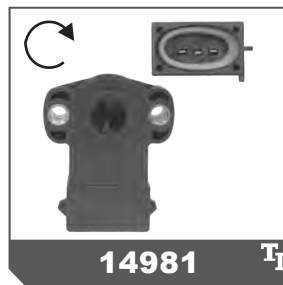
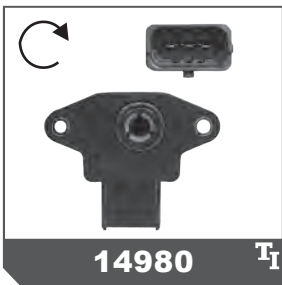
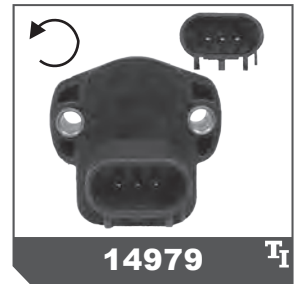
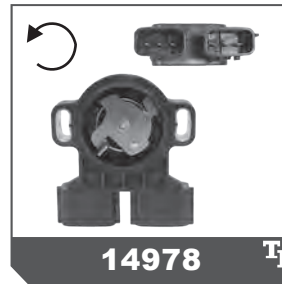
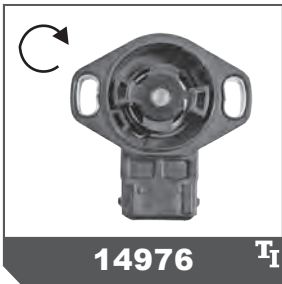
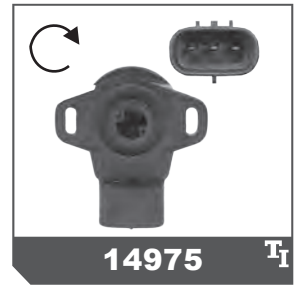
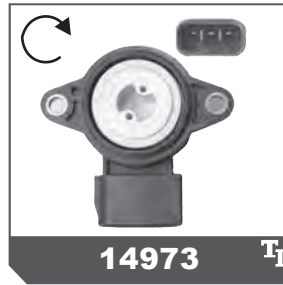
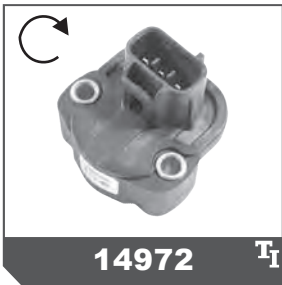
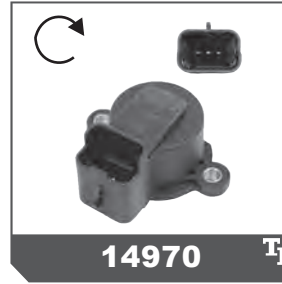
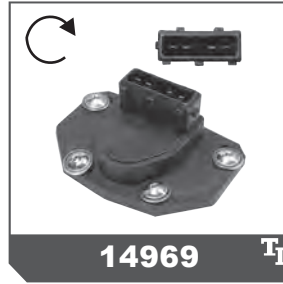
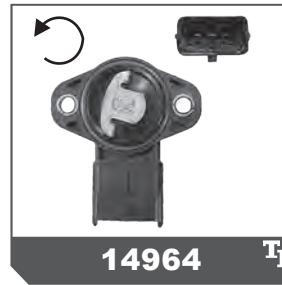
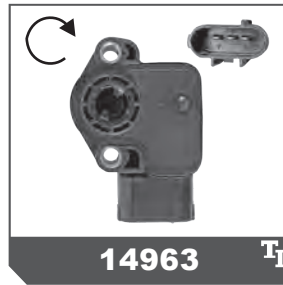

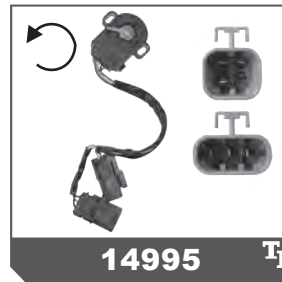
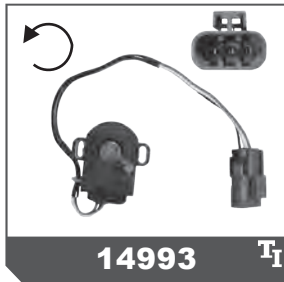
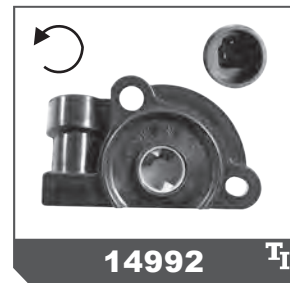
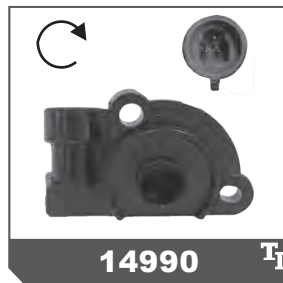
**SENSORES DE POSICIÓN DEL ACELERADOR**

**SENSORES DE POSICIÓN DEL ÁRBOL DE LEVAS (CMP)**
**SU FUNCIÓN:**

Indican la posición del árbol de levas al módulo de encendido.

Esta información es usada para el tiempo de apertura de los inyectores y el tiempo de ignición.

**SÍNTOMAS DE FALLA:**

El vehículo no arranca, tarda en responder o produce explosiones en el arranque.

**MANTENIMIENTO/SERVICIO:**

Checar si hay códigos de falla y diagnosticar si es necesario.

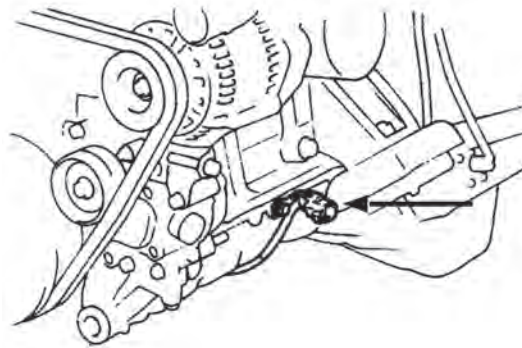

ACURA					
MODELO	AÑO	CIL.	MOTOR	SISTEMA	No. PARTE
ILX	13-15	4	2.0		22380
MDX	05-06	6	3.5		22381
MDX	07-10	6	3.7		22381
RDX TURBO	07-12	4	2.3	MPFI	22324
RL	05-08	6	3.5		22381
RL	09-10	6	3.7		22381
TL	05-08	6	3.2		22381

AUDI					
MODELO	AÑO	CIL.	MOTOR	SISTEMA	No. PARTE
A1 TURBO	11-17	4	1.4	MPFI	22266

AUDI					
MODELO	AÑO	CIL.	MOTOR	SISTEMA	No. PARTE
A3 QUATTRO	06-08	6	3.2		22266
A3 TURBO	06-08	4	2.0		22246
A4	02-05	6	3.0		22246
A4 QUATTRO	02-05	6	3.0		22246
A4 QUATTRO TURBO	05-09	4	2.0		22246
A4 QUATTRO TURBO	99-05	4	1.8		22280
A4 TURBO	05-09	4	2.0	MPFI	22246
A4 TURBO	97-06	4	1.8		22280
A6	02-04	6	3.0		22246
A6	99-01	6	2.8		22280
A6 QUATTRO	04-04	6	3.0		22280
A6 QUATTRO	00-04	8	4.2		22280
A6 QUATTRO BITURBO	00-03	6	2.7		22280

CONTINÚA»

AUDI					
MODELO	AÑO	CIL.	MOTOR	SISTEMA	No. PARTE
A6 QUATTRO VR6	99-01	6	2.8	MPFI	22280
A8 QUATTRO	12-13	12	6.3		22266
A8 QUATTRO	97-06	8	4.2		22280
A8 QUATTRO	06-09	12	6.0		22309
ALLROAD QUATTRO BITURBO	01-05	6	2.7		22280
Q7	07-10	6	3.6		22266
S3 TURBO	04-04	4	1.8		22246
S4	04-09	8	4.2		22246
S6	04-04	8	4.2		22246
S6	01-03	8	4.2		22280
S6	07-08	10	5.2		22309
S8	07-08	10	5.2		22309
TT QUATTRO	08-09	6	3.2		22266
TT QUATTRO	04-06	6	3.2		22309
TT QUATTRO TURBO	09-14	4	2.0		22246
TT QUATTRO TURBO	00-06	4	1.8		22280
TT TURBO	08-08	4	2.0		22246
TT TURBO	00-06	4	1.8		22280

BMW					
MODELO	AÑO	CIL.	MOTOR	SISTEMA	No. PARTE
135i	08-08	6	3.0	MPFI	22266

CHRYSLER						
MODELO	AÑO	CIL.	MOTOR	SISTEMA	No. PARTE	
200	12-14	4	2.4	MPFI	22364	
200	12-16	6	3.6		22365	
300	12-15	8	5.7		22335	
300	12-17	6	3.6		22365	
300 SRT-8	12-14	8	6.4		22335	
300C	05-07	8	5.7		22281	
300C	08-10	8	5.7		22335	
300C	05-06	6	3.5		22292	
300C	<b>NUEVO</b>	07-10	6		3.5	22472
300C SRT-8	06-07	8	6.1		22281	
300C SRT-8	08-08	8	6.1		22335	
300M	99-04	6	3.5		22293	
ASPEN	07-07	8	5.7		22281	
ASPEN	08-09	8	5.7		22335	
CIRRUS	96-00	4	2.4		22021	
CONCORDE	02-02	6	3.5		22293	
GRAND VOYAGER	94-97	6	3.8		22025	
GRAND VOYAGER	91-93	6	3.3		22028	
GRAND VOYAGER	98-00	6	3.8		22267	
PACIFICA	07-07	6	3.8		22267	
PACIFICA	04-06	6	3.5		22292	
PACIFICA	<b>NUEVO</b>	07-08	6		4.0	22472
PT CRUISER	01-10	4	2.4		22021	
TOWN & COUNTRY	94-97	6	3.8		22025	
TOWN & COUNTRY	93-93	6	3.3		22028	
TOWN & COUNTRY	98-07	6	3.8		22267	
TOWN & COUNTRY	11-16	6	3.6		22365	
TOWN & COUNTRY	<b>NUEVO</b>	08-10	6		4.0	22472
VOYAGER	94-97	6	3.3		22025	
VOYAGER	91-93	6	3.3		22028	
VOYAGER	98-03	6	3.3		22267	

CHRYSLER		DODGE			
MODELO	AÑO	CIL.	MOTOR	SISTEMA	No. PARTE
ATOS	01-04	4	1.0	MPFI	22303
ATOS	05-12	4	1.1		22303
ATTITUDE	06-11	4	1.4		22332
ATTITUDE	12-14	4	1.6		22470
ATTITUDE	09-09	4	1.6		22269
ATTITUDE	06-11	4	1.6		22332
AVENGER	08-13	4	2.4	22364	

CHRYSLER		DODGE			
MODELO	AÑO	CIL.	MOTOR	SISTEMA	No. PARTE
AVENGER	<b>NUEVO</b>	08-10	6	3.5	22472
CALIBER		07-09	4	1.8	22364
CALIBER		07-09	4	2.0	22364
CALIBER		07-12	4	2.4	22364
CHALLENGER		13-17	6	3.6	22365
CHALLENGER R/T		09-14	8	5.7	22335
CHALLENGER SRT-8		08-10	8	6.1	22335
CHALLENGER SRT-8		11-15	8	6.4	22335
CHARGER		06-06	6	3.5	22292
CHARGER		11-13	6	3.6	22365
CHARGER	<b>NUEVO</b>	07-10	6	3.5	22472
CHARGER R/T		09-15	8	5.7	22335
CHARGER R/T		06-08	8	5.7	22281
CHARGER SRT-8		07-08	8	6.1	22281
CHARGER SRT-8		09-10	8	6.1	22335
CHARGER SRT-8		12-14	8	6.4	22335
DAKOTA		05-07	6	3.7	22281
DAKOTA		08-10	6	3.7	22335
DAKOTA		11-11	6	3.7	22335
DAKOTA		07-07	8	4.7	22281
DAKOTA		07-07	8	4.7	22335
DURANGO		12-15	6	3.6	22365
DURANGO		08-07	8	4.7	22335
DURANGO		00-07	8	4.7	22281
DURANGO		08-15	8	5.7	22335
DURANGO		04-07	8	5.7	22281
GRAND CARAVAN		17-17	6	3.6	22365
H100 VAN		12-14	4	2.4	22376
i10		12-14	4	1.1	22303
INTREPID		98-98	6	2.7	22450
INTREPID		98-01	6	3.2	MPFI 22293
INTREPID		00-01	6	3.5	22293
JOURNEY		09-17	4	2.4	22364
JOURNEY	<b>NUEVO</b>	09-10	6	3.5	22472
JOURNEY R/T		11-17	6	3.6	22365
NEON		95-05	4	2.0	22023
NEON		95-99	4	2.0	22021
NEON SRT-4		04-05	4	2.4	22021
NITRO		07-07	6	3.7	22281
NITRO		08-12	6	3.7	22335
NITRO R/T	<b>NUEVO</b>	07-09	6	4.0	22472
PROMASTER 1500		14-17	6	3.6	22365
PROMASTER 2500		14-17	6	3.6	22365
PROMASTER 3500		14-17	6	3.6	22365
RAM 1500		14-17	6	3.6	22365
RAM 1500		02-06	6	3.7	22281
RAM 1500		09-13	6	3.7	22335
RAM 1500		02-02	6	3.9	22281
RAM 2500		03-07	8	4.7	22281
RAM 2500		08-10	8	4.7	22335
RAM 2500		03-07	8	5.7	22281
RAM 2500		08-10	8	5.7	22335
RAM 4000		05-08	8	5.7	22281
RAMCHARGER		00-00	8	5.2	22468
RAMCHARGER		00-00	8	5.9	22468
STRATUS		95-05	4	2.0	22023
STRATUS		01-02	4	2.4	22303
STRATUS		95-06	4	2.4	22021
VAN 1000		08-09	4	2.4	22249
VERNA		04-06	4	1.5	22269
VERNA		04-06	4	1.6	22269

CHRYSLER		JEEP			
MODELO	AÑO	CIL.	MOTOR	SISTEMA	No. PARTE
CHEROKEE	14-17	6	3.2	MPFI	22365
CHEROKEE SPORT	00-01	6	4.0		22268



CHRYSLER		JEEP				
MODELO	AÑO	CIL.	MOTOR	SISTEMA	No. PARTE	
COMMANDER	06-07	8	4.7	MPFI	22281	
COMMANDER	06-07	8	5.7		22281	
COMMANDER	08-10	8	5.7		22335	
COMPASS	07-17	4	2.4		22364	
GRAND CHEROKEE	99-04	6	4.0		22268	
GRAND CHEROKEE	05-07	6	3.7		22281	
GRAND CHEROKEE	05-07	8	5.7		22281	
GRAND CHEROKEE	99-07	8	4.7		22281	
GRAND CHEROKEE	08-09	8	4.7		22335	
GRAND CHEROKEE	09-10	6	3.7		22335	
GRAND CHEROKEE	08-15	8	5.7		22335	
GRAND CHEROKEE	11-17	6	3.6		22365	
GRAND CHEROKEE SRT-8	06-07	8	6.1		22281	
GRAND CHEROKEE SRT-8	08-10	8	6.1		22335	
GRAND CHEROKEE SRT-8	12-15	8	6.4		22335	
LIBERTY	02-07	6	3.7		22281	
LIBERTY	08-12	6	3.7		22335	
PATRIOT	07-17	4	2.4		22364	
WRANGLER	07-07	6	3.8		22267	
WRANGLER	00-04	6	4.0		22268	
WRANGLER	12-17	6	3.6	22365		
WRANGLER	05-06	6	4.0	22469		

CHRYSLER		PLYMOUTH				
MODELO	AÑO	CIL.	MOTOR	SISTEMA	No. PARTE	
BREEZE	96-96	4	2.0	MPFI	22023	

FIAT						
MODELO	AÑO	CIL.	MOTOR	SISTEMA	No. PARTE	
500 SPORT	12-15	4	1.4	MPFI	22399	
GRANDE PUNTO	07-09	4	1.4		22399	

FORD						
MODELO	AÑO	CIL.	MOTOR	SISTEMA	No. PARTE	
AEROSTAR	97-95	6	4.0	MPFI	22297	
CONTOUR	95-97	4	2.0		22307	
CONTOUR	98-00	4	2.0		22330	
CONTOUR	95-00	6	2.5		22037	
COURIER	01-12	4	1.6		22302	
ECONOLINE E-150	97-03	6	4.2		22297	
ECONOLINE E-150	04-08	8	4.6		22003	
ECONOLINE E-150	04-08	8	5.4		22003	
ECONOLINE E-250	97-03	6	4.2		22297	
ECONOLINE E-350	97-98	8	5.4		22003	
ECOSPORT	04-08	4	2.0		22272	
EDGE	07-15	6	3.5		22367	
EDGE TURBO	17-17	4	2.0		22462	
ESCAPE	05-08	4	2.3		22272	
ESCAPE	09-15	4	2.5		22342	
ESCAPE	01-06	6	3.0		22037	
ESCAPE DERECHO	07-08	6	3.0		22460	
ESCAPE IZQUIERDO	07-08	6	3.0		22461	
ESCAPE TURBO	14-17	4	2.0		22462	
ESCORT	94-96	4	1.9		22009	
ESCORT	97-01	4	2.0		22009	
ESCORT	98-00	4	2.0		22330	
EXCURSION	01-05	10	6.8		22003	
EXPEDITION	97-04	8	4.6		22003	
EXPEDITION	97-14	8	5.4		22003	
EXPLORER	11-15	6	3.5		22367	
EXPLORER	00-07	6	4.0		22302	
EXPLORER	95-99	6	4.0		22297	
EXPLORER	99-00	6	4.0		22289	
EXPLORER	02-10	8	4.6		22003	
EXPLORER	96-99	8	5.0	22297		
EXPLORER	99-01	8	5.0	22289		

FORD						
MODELO	AÑO	CIL.	MOTOR	SISTEMA	No. PARTE	
EXPLORER SPORT TRAC	07-10	8	4.6	MPFI	22003	
F-150	10-14	6	3.7		22367	
F-150	05-08	6	4.2		22297	
F-150	97-03	6	4.2		22297	
F-150	11-14	8	5.0		22463	
F-350 SUPER DUTY	00-10	8	5.4		22003	
F-350 SUPER DUTY	11-14	8	6.2		22372	
F-450 SUPER DUTY	11-17	10	6.8		22003	
F-450 SUPER DUTY	02-08	10	6.8		22003	
F-550 SUPER DUTY	11-17	10	6.8		22003	
F-550 SUPER DUTY	02-08	10	6.8		22003	
FIESTA	11-17	4	1.6		22471	
FIESTA	03-07	4	1.6		22302	
FIVE HUNDRED	05-07	6	3.0		22037	
FOCUS	12-17	4	2.0		22462	
FOCUS	05-07	4	2.0		22272	
FOCUS	07-07	4	2.0		22307	
FOCUS	08-11	4	2.0		22342	
FOCUS	00-04	4	2.0		22307	
FOCUS DOHC	02-03	4	2.0		22330	
FOCUS RS	16-17	4	2.3		22462	
FOCUS ST	13-17	4	2.0		22462	
FOCUS STATION WAGON	00-04	4	2.0		22307	
FOCUS ZX3	00-04	4	2.0		22307	
FREESTAR	04-07	6	4.2		22289	
FUSION	07-09	4	2.3		22342	
FUSION	10-15	4	2.5		22342	
FUSION DERECHO	06-10	6	3.0		22460	
FUSION IZQUIERDO	06-10	6	3.0		22461	
FUSION TURBO	13-16	4	2.0		22462	
FUSION SPORT	10-12	6	3.5	22367		
IKON	01-07	4	1.6	22302		
KA	01-08	4	1.6	22302		
LOBO	04-06	8	4.6	22037		
LOBO	01-06	8	5.4	22037		
MONDEO	01-06	4	2.0	22302		
MONDEO	02-04	6	2.5	22037		
MUSTANG	11-15	6	3.7	22367		
MUSTANG	05-10	6	4.0	22302		
MUSTANG	00-10	8	4.6	22003		
MUSTANG ESCAPE	11-15	8	5.0	22463		
MUSTANG SHELBY GT	08-12	8	5.4	22003		
RANGER	01-11	4	2.3	22272		
RANGER	96-97	4	2.3	22040		
RANGER	96-00	6	3.0	22297		
RANGER	99-02	6	3.0	22289		
THUNDERBIRD	89-95	6	3.8	22348		
THUNDERBIRD	96-96	6	3.8	22297		
TRANSIT TDI	07-13	4	2.2	22343		
WINDSTAR	95-95	6	3.8	22348		
WINDSTAR	96-98	6	3.8	22297		
WINDSTAR	98-03	6	3.8	22289		

FORD		LINCOLN				
MODELO	AÑO	CIL.	MOTOR	SISTEMA	No. PARTE	
AVIATOR	05-05	8	4.6	MPFI	22003	
MARK LT	06-08	8	5.4		22003	
MKS	09-14	6	3.7		22367	
MKS TURBO	11-11	6	3.5		22367	
MKX	07-10	6	3.5		22367	
MKX	11-15	6	3.7		22367	
MKZ	07-12	6	3.5		22367	
MKZ	14-16	6	3.7		22367	
MKZ TURBO	13-16	4	2.0		22462	
NAVIGATOR	02-14	8	5.4		22003	
TOWN CAR	00-07	8	4.6		22003	

# SENSORES DE POSICIÓN DEL ÁRBOL DE LEVAS (CMP)

FORD		LINCOLN			
MODELO	AÑO	CIL.	MOTOR	SISTEMA	No. PARTE
ZEPHYR DERECHO	06-06	6	3.0	MPFI	22460
ZEPHYR IZQUIERDO	06-06	6	3.0		22461

FORD		MERCURY			
MODELO	AÑO	CIL.	MOTOR	SISTEMA	No. PARTE
GRAND MARQUIS	00-04	8	4.6	MPFI	22003
MARINER	05-06	6	3.0		22037
MARINER DERECHO	07-08	6	3.0		22460
MARINER IZQUIERDO	07-08	6	3.0		22461
MILAN DERECHO	07-08	6	3.0		22460
MILAN IZQUIERDO	07-08	6	3.0		22461
MONTEGO	05-07	6	3.0		22037
MYSTIQUE	95-00	6	2.5		22037
MYSTIQUE	95-95	4	2.0		22307
MYSTIQUE	98-00	4	2.0		22330
SABLE	96-04	6	3.0		22037

GENERAL MOTORS		BUICK			
MODELO	AÑO	CIL.	MOTOR	SISTEMA	No. PARTE
CENTURY	94-95	6	3.1	MPFI	22006
ENCLAVE	10-10	6	3.6		22369
ENCLAVE	11-15	6	3.6		22466
LACROSSE	10-16	6	3.6		22466
REGAL TURBO	13-13	4	2.0		22259
VERANO	14-16	4	2.4		22259
VERANO TURBO	13-16	4	2.0		22259

GENERAL MOTORS		CADILLAC			
MODELO	AÑO	CIL.	MOTOR	SISTEMA	No. PARTE
CTS	07-09	6	3.6	MPFI	22369
CTS	10-15	6	3.6		22466
ESCALADE	02-06	8	6.0		22263
ESCALADE	02-05	8	5.3		22263
ESCALADE	07-14	8	6.2		22451
ESCALADE	09-13	8	6.0		22451
ESCALADE ESV	03-06	8	6.0		22263
ESCALADE ESV	07-14	8	6.2		22451
ESCALADE EXT	03-06	8	6.0		22263
ESCALADE EXT	07-13	8	6.2		22451
SRX	12-16	6	3.6		22466
STS	07-09	6	3.6		22369
STS	10-10	6	3.6		22466

GENERAL MOTORS		CHEVROLET			
MODELO	AÑO	CIL.	MOTOR	SISTEMA	No. PARTE
ASTRA	04-06	4	2.4	MPFI	22311
ASTRA	00-03	4	1.8		22349
AVALANCHE	02-06	8	5.3		22263
AVALANCHE	07-13	8	5.3		22451
AVEO	08-17	4	1.6		22258
BEAT	18-18	4	1.2		22379
BLAZER	95-01	6	4.3		22298
CAMARO	95-95	6	3.4		22006
CAMARO	99-02	8	5.7		22263
CAMARO	10-16	8	6.2		22451
CAMARO	10-16	6	3.6		22466
CAPTIVA SPORT	08-15	4	2.4		22259
CAPTIVA SPORT	08-10	6	3.6		22369
CAPTIVA SPORT	11-15	6	3.0		22466
CAVALIER	96-02	4	2.2		22019
CAVALIER Z24	95-97	4	2.4		22017
COLORADO	04-06	5	3.5		22283
CORVETTE	99-04	8	5.7		22263
CORVETTE	05-07	8	6.0		22451
CORVETTE	08-13	8	6.2		22451
CRUZE FRONTAL	11-15	4	1.8		22459

GENERAL MOTORS		CHEVROLET			
MODELO	AÑO	CIL.	MOTOR	SISTEMA	No. PARTE
CRUZE TRASERO	11-15	4	1.8	MPFI	22455
EQUINOX	05-06	6	3.4		22346
EXPRESS 1500	03-07	8	5.3		22263
EXPRESS 1500	96-06	6	4.3		22298
EXPRESS 1500	08-13	8	5.3		22451
EXPRESS 2500	98-02	8	5.7		22298
EXPRESS 3500	03-07	8	6.0		22263
EXPRESS 3500	96-02	8	5.7		22298
EXPRESS 3500	08-13	8	6.0		22451
HHR	06-09	4	2.4		22259
IMPALA	00-03	6	3.8		22015
IMPALA	00-02	6	3.4		22294
KODIAK	99-01	8	8.1		22298
MALIBU	97-02	4	2.4		22017
MALIBU	97-99	6	3.1		22018
MALIBU	08-12	4	2.4		22259
MALIBU	07-07	4	2.2		22259
MALIBU	00-02	6	3.1		22294
MALIBU	04-06	6	3.5		22346
MALIBU	03-03	6	3.1		22346
MALIBU	08-09	6	3.6		22369
MALIBU	10-12	6	3.6		22466
MATIZ	11-15	4	1.0		22326
OPTRA	06-10	4	2.0		22325
P30	96-99	8	5.7		22298
S10	96-03	4	2.2		22019
SILVERADO 1500	02-08	6	4.3	22298	
SILVERADO 1500	08-13	6	4.3	22451	
SILVERADO 2500	99-07	8	5.3	22263	
SILVERADO 2500	03-07	8	4.8	22263	
SILVERADO 3500	01-01	8	8.1	22002	
SILVERADO 3500	01-06	8	6.0	22263	
SILVERADO 3500	99-06	8	5.7	22298	
SILVERADO 3500	99-01	8	7.4	22298	
SILVERADO 3500	04-06	8	8.1	22451	
SILVERADO 3500 HD	99-01	8	8.1	22298	
SONIC FRONTAL	12-17	4	1.6	22459	
SONIC TRASERO	12-17	4	1.6	22455	
SONORA	00-02	8	5.7	22298	
SPARK CLASSIC	11-17	4	1.2	22379	
SUBURBAN	98-99	8	5.7	22298	
SUBURBAN	07-14	8	5.3	22451	
SUBURBAN 1500	00-06	8	5.3	22263	
SUBURBAN 2500	00-06	8	6.0	22263	
SUBURBAN 2500	07-13	8	6.0	22451	
TAHOE	07-14	8	5.3	22451	
TRACKER	99-03	4	2.0	22249	
TRAIL BLAZER	03-04	8	5.3	22263	
TRAIL BLAZER	02-05	6	4.2	22283	
TRAIL BLAZER	06-06	8	5.3	22451	
TRAIL BLAZER EXT	03-04	8	5.3	22263	
TRAIL BLAZER EXT	02-05	6	4.2	22283	
TRAIL BLAZER EXT	05-06	8	5.3	22451	
TRAVERSE	09-09	6	3.6	22369	
TRAVERSE	10-15	6	3.6	22466	
TRAX FRONTAL	13-16	4	1.8	22459	
TRAX TRASERO	13-16	4	1.8	22455	
UPLANDER	05-06	6	3.5	22346	
VENTURE	97-99	6	3.4	22006	
VENTURE	00-02	6	3.4	22294	
VENTURE	03-04	6	3.4	22346	

GENERAL MOTORS		GMC			
MODELO	AÑO	CIL.	MOTOR	SISTEMA	No. PARTE
ACADIA	07-10	6	3.6	MPFI	22369
ACADIA	11-15	6	3.6		22466

CONTINÚA»



**SENSORES DE POSICIÓN DEL ÁRBOL DE LEVAS (CMP)**

GENERAL MOTORS		GMC			
MODELO	AÑO	CIL.	MOTOR	SISTEMA	No. PARTE
SIERRA	10-10	8	5.3	MPFI	22451
SIERRA 1500	07-13	8	5.3		22451
SIERRA 1500 DENALI	08-13	8	6.2		22451
SIERRA DENALI	10-10	8	6.2		22451
TERRAIN	12-12	6	3.0		22466
TERRAIN	13-16	6	3.6		22466
YUKON	07-09	8	5.3		22451
YUKON	07-15	8	6.2		22451

GENERAL MOTORS		HUMMER			
MODELO	AÑO	CIL.	MOTOR	SISTEMA	No. PARTE
H2	05-07	8	6.0	MPFI	22263
H2	08-09	8	6.2		22451
H3	06-06	5	3.5		22283
H3	08-10	8	5.3		22451
H3T	09-10	8	5.3		22451

GENERAL MOTORS		OLDSMOBILE			
MODELO	AÑO	CIL.	MOTOR	SISTEMA	No. PARTE
88	92-92	6	3.8	MPFI	22000
88	93-94	6	3.8		22005
88	95-95	6	3.8		22015

GENERAL MOTORS		PONTIAC			
MODELO	AÑO	CIL.	MOTOR	SISTEMA	No. PARTE
AZTEK	01-02	6	3.4	MPFI	22294
AZTEK	03-05	6	3.4		22346
BONNEVILLE	95-99	6	3.8		22015
G3	07-09	4	1.6		22258
G5	07-08	4	2.2		22259
G5 GT	07-09	4	2.4		22259
G6	05-06	6	3.5		22346
G6	07-09	6	3.6		22369
GRAND AM	99-99	6	3.4		22018
GRAND AM	00-02	6	3.4		22294
GRAND AM	03-04	6	3.4		22346
GRAND PRIX	97-99	6	3.1		22006
GRAND PRIX SC	97-01	6	3.8		22015
MATIZ	04-10	4	1.0		22326
MONTANA	05-06	6	3.5		22346
SOLSTICE	06-08	4	2.4		22259
SUNFIRE	97-02	4	2.4		22017
SUNFIRE	96-02	4	2.2		22019
TORRENT	06-06	6	3.4		22346

HONDA					
MODELO	AÑO	CIL.	MOTOR	SISTEMA	No. PARTE
ACCORD	98-02	6	3.0	MPFI	22316
ACCORD	03-07	6	3.0		22381
ACCORD LADO DE ADMISION	03-07	4	2.4		22370
ACCORD LADO DE ESCAPE	03-07	4	2.4		22324
CIVIC	01-05	4	1.7		22347
CIVIC	06-15	4	1.8		22380
CIVIC SI LADO DE ADMISION	07-11	4	2.0		22370
CIVIC SI LADO DE ESCAPE	07-11	4	2.0		22324
CR-V LADO DE ADMISION	07-09	4	2.4		22370
CR-V LADO DE ESCAPE (DESDE 2007)	02-09	4	2.4		22324
FIT	06-08	4	1.5		22324
ODYSSEY	00-04	6	3.5		22316
ODYSSEY	05-10	6	3.5		22381
PILOT	03-04	6	3.5		22316
PILOT	05-08	6	3.5		22381
RIDGELINE	07-08	6	3.5		22381

HYUNDAI					
MODELO	AÑO	CIL.	MOTOR	SISTEMA	No. PARTE
SONATA	15-15	4	2.4	MPFI	22376

KIA					
MODELO	AÑO	CIL.	MOTOR	SISTEMA	No. PARTE
OPTIMA	16-16	4	2.4	MPFI	22376
OPTIMA TURBO	16-16	4	2.0		22376
SPORTAGE	16-16	4	2.0		22376

MAZDA					
MODELO	AÑO	CIL.	MOTOR	SISTEMA	No. PARTE
2	12-15	4	1.5	MPFI	22453
3	06-13	4	2.0		22342
3	14-17	4	2.0		22467
3	06-09	4	2.3		22342
3 SPEED TURBO	11-13	4	2.3		22454
3 SPEED TURBO	08-08	4	2.3		22454
3 SPEED TURBO	09-10	4	2.3		22376
3	10-13	4	2.5		22342
3	14-17	4	2.5		22467
5	06-07	4	2.3		22272
5	08-10	4	2.3		22342
5	12-15	4	2.5		22342
6	06-08	4	2.3		22342
6	09-13	4	2.5		22342
6	14-17	4	2.5		22467
6	09-13	6	3.7		22367
6 DERECHO	06-08	6	3.0		22460
6 IZQUIERDO	06-08	6	3.0		22461
CX-5	13-17	4	2.0		22467
CX-5	14-17	4	2.5		22467
CX-7	10-12	4	2.5		22342
CX-7 TURBO	07-12	4	2.3		22454
CX-9	07-07	6	3.5	22367	
CX-9	09-15	6	3.7	22367	
CX-9	08-08	6	3.7	22272	
CX-9 TURBO	16-17	4	2.5	22467	
MX-5 MIATA	07-14	4	2.0	22342	
MX-5 MIATA	06-06	4	2.0	22272	

MERCEDES BENZ					
MODELO	AÑO	CIL.	MOTOR	SISTEMA	No. PARTE
C63 AMG	11-14	8	6.2	MPFI	22369
CL63 AMG	10-10	8	6.2		22369
CLS63 AMG	10-11	8	6.3		22369
E63 AMG	10-11	8	6.3		22369
ML63 AMG	10-11	8	6.2		22369
SL63 AMG	11-12	8	6.2		22369
SLS AMG	11-14	8	6.2		22369

MINI					
MODELO	AÑO	CIL.	MOTOR	SISTEMA	No. PARTE
COOPER COUNTRYMAN	11-14	4	1.6	MPFI	22457
COOPER PACEMAN	13-14	4	1.6		22457
COOPER TURBO	07-14	4	1.6		22457
COOPER TURBO	14-14	3	1.5		22457
COOPER TURBO	14-14	4	2.0		22457

MITSUBISHI					
MODELO	AÑO	CIL.	MOTOR	SISTEMA	No. PARTE
ECLIPSE	06-12	6	3.8	MPFI	22249
ENDEAVOR	04-08	6	3.8		22249
ENDEAVOR	10-11	6	3.8		22249
GALANT	04-09	4	2.4		22249
GALANT	05-09	6	3.8		22249
GRANDIS	07-09	4	2.4		22249
LANCER	04-07	4	2.0		22397

CONTINÚA))

# SENSORES DE POSICIÓN DEL ÁRBOL DE LEVAS (CMP)

MITSUBISHI					
MODELO	AÑO	CIL.	MOTOR	SISTEMA	No. PARTE
LANCER RALLIART	05-06	4	2.4	MPFI	22249
MONTERO SPORT	03-04	6	3.5		22452
OUTLANDER	04-06	4	2.4		22249

NISSAN			INFINITI		
MODELO	AÑO	CIL.	MOTOR	SISTEMA	No. PARTE
FX35	12-12	6	3.5	MPFI	22456
I30	98-01	6	3.0		22345

NISSAN					
MODELO	AÑO	CIL.	MOTOR	SISTEMA	No. PARTE
350Z	07-08	6	3.5	MPFI	22456
350Z BANCO DERECHO	03-06	6	3.5		22360
ALTIMA	07-16	4	2.5		22456
ALTIMA	07-16	6	3.5		22456
ALTIMA	02-06	4	2.5		22250
ALTIMA BANCO DERECHO	02-06	6	3.5		22360
ALTIMA 2 PIEZAS	02-06	4	2.5		22282
FRONTIER	06-08	4	2.4		22250
FRONTIER BANCO DERECHO	08-14	6	4.0		22360
MARCH	12-18	4	1.6		22373
MAXIMA	95-01	6	3.0		22345
MAXIMA	09-15	6	3.5		22456
MAXIMA BANCO DERECHO	02-08	6	3.5		22360
MURANO	09-14	6	3.5		22456
MURANO BANCO DERECHO	04-07	6	3.5		22360
NOTE	14-18	4	1.6		22373
NP300 TDI	09-11	4	2.5		22250
NP300 TDI 2 PIEZAS	09-11	4	2.5		22282
NP300 TDI BANCO DERECHO	12-12	4	2.5		22360
NV2500 BANCO DERECHO	13-14	6	4.0		22360
PATHFINDER	13-16	6	3.5		22456
PATHFINDER BANCO DERECHO	05-12	6	4.0		22360
PATHFINDER LADO DE ADMISION	01-04	6	3.5		22344
PATHFINDER LADO DE ESCAPE	01-02	6	3.5		22406
QUEST	04-09	6	3.5		22360
ROGUE	08-14	4	2.5		22456
SENTRA	07-12	4	2.0		22359
SENTRA	13-15	4	1.8		22359
SENTRA	01-06	4	1.8		22299
SENTRA SE-R	07-12	4	2.5		22456
SENTRA SE-R	02-06	4	2.5	22250	
SENTRA SE-R 2 PIEZAS	02-06	4	2.5	22282	
TIIDA	07-18	4	1.8	22359	
TIIDA	13-18	4	1.6	22373	
URVAN	08-13	4	2.5	22250	
URVAN 2 PIEZAS	08-13	4	2.5	22282	
VERSA	12-18	4	1.6	22373	
XTERRA BANCO DERECHO	05-07	6	4.0	22360	
X-TRAIL	08-14	4	2.5	22456	
X-TRAIL	02-07	4	2.5	22250	
X-TRAIL 2 PIEZAS	02-07	4	2.5	22282	

PORSCHE					
MODELO	AÑO	CIL.	MOTOR	SISTEMA	No. PARTE
CAYENNE	08-13	6	3.6	MPFI	22266
CAYENNE	04-06	6	3.2		22309

RENAULT					
MODELO	AÑO	CIL.	MOTOR	SISTEMA	No. PARTE
SCALA	11-13	4	1.6	MPFI	22299

SEAT					
MODELO	AÑO	CIL.	MOTOR	SISTEMA	No. PARTE
ALHAMBRA TURBO	04-04	4	1.8	MPFI	22280
CORDOBA	04-07	4	1.6		22266

SEAT					
MODELO	AÑO	CIL.	MOTOR	SISTEMA	No. PARTE
CORDOBA	03-07	4	2.0	MPFI	22266
IBIZA	01-08	4	1.6		22266
IBIZA	03-15	4	2.0		22286
LEON FR	07-11	4	2.0		22246
LEON TURBO	08-11	4	1.4		22266
LEON TURBO	01-03	4	1.8		22280
TOLEDO TURBO	01-03	4	1.8		22280

SUZUKI					
MODELO	AÑO	CIL.	MOTOR	SISTEMA	No. PARTE
GRAND VITARA	09-10	6	3.2	MPFI	22369
XL-7	07-09	6	3.6		22369

TOYOTA					
MODELO	AÑO	CIL.	MOTOR	SISTEMA	No. PARTE
4RUNNER	06-09	6	4.0	MPFI	22382
4RUNNER	05-09	8	4.7		22465
AVANZA	12-15	4	1.5		22314
CAMRY	04-06	6	3.0		22314
CAMRY	02-11	4	2.4		22314
CAMRY	07-16	6	3.5		22382
CAMRY	10-16	4	2.5		22382
COROLLA	03-08	4	1.8		22314
COROLLA	09-16	4	1.8		22382
COROLLA XRS	09-13	4	2.4		22314
FJ CRUISER	08-14	6	4.0		22382
HIACE	06-07	4	2.7		22314
HIACE	08-16	4	2.7		22465
HIGHLANDER	08-16	6	3.5		22382
HILUX	06-11	4	2.7		22314
LAND CRUISER	08-11	8	5.7		22382
LAND CRUISER	13-16	8	5.7		22382
MATRIX	07-08	4	1.8		22314
MATRIX	09-10	4	2.4		22314
MATRIX	09-10	4	1.8		22382
MATRIX	03-06	4	1.8		22391
MR2 SPYDER	05-05	4	1.8		22314
PRIUS HIBRIDO	10-16	4	1.8		22382
RAV4	04-08	4	2.4		22314
RAV4	09-17	4	2.5		22382
RAV4	09-12	6	3.5		22382
SEQUOIA	08-08	8	4.7		22382
SEQUOIA	10-12	8	4.6		22382
SEQUOIA	09-16	8	5.7		22382
SEQUOIA	08-09	8	4.7		22465
SIENNA	04-06	6	3.3	22314	
SIENNA	07-16	6	3.5	22382	
SOLARA	05-06	6	3.3	22314	
TACOMA	06-15	6	4.0	22382	
TUNDRA	07-07	6	4.0	22382	
TUNDRA	11-14	8	5.7	22382	
TUNDRA	07-10	8	4.7	22465	
YARIS	06-17	4	1.5	22314	

VOLKSWAGEN					
MODELO	AÑO	CIL.	MOTOR	SISTEMA	No. PARTE
BEETLE	06-16	5	2.5	MPFI	22246
BEETLE	98-05	4	2.0		22286
BEETLE TURBO	99-06	4	1.8		22280
BORA	06-10	5	2.5		22246
CROSSFOX	07-09	4	1.6		22266
CROSSFOX	11-17	4	1.6		22266
DERBY	95-09	4	1.8		22304
DERBY	01-03	4	2.0		22304
EOS TURBO	10-10	4	2.0		22246
EUROVAN	01-03	5	2.5		22309

**SENSORES DE POSICIÓN DEL ÁRBOL DE LEVAS (CMP)**

VOLKSWAGEN					
MODELO	AÑO	CIL.	MOTOR	SISTEMA	Nº. PARTE
EUROVAN TDI	06-09	4	1.9	MPFI	22315
EUROVAN VR6	01-04	6	2.8		22309
GOL	09-17	4	1.6		22266
GOLF A2	88-89	4	1.8		22300
GOLF A2	90-91	4	2.0		22300
GOLF A3	93-98	4	1.8		22304
GOLF A3	93-98	4	2.0		22304
GOLF A4	00-06	4	2.0		22286
GOLF A4 GTI	00-05	4	1.8		22280
GOLF A4 R32	04-04	6	3.2		22309
GOLF A5 GTI	07-07	4	2.0		22246
GOLF A5 SPORT WAGEN	10-11	5	2.5		22246
GOLF A6 GTI	12-13	4	2.0		22246
JETTA A2	87-89	4	1.8		22300
JETTA A3	93-99	4	1.8		22304
JETTA A3	93-99	4	2.0		22304
JETTA A4	00-10	4	2.0		22286
JETTA A4 CLASICO	10-15	4	2.0		22286
JETTA A4 TDI	06-06	4	1.9		22315
JETTA A4 TURBO	99-05	4	1.8		22280
JETTA A4 VR6	99-04	6	2.8		22309
JETTA A6	11-16	5	2.5		22246
JETTA A6	13-16	4	2.0		22286
LUPO	05-09	4	1.6		22266
PASSAT	12-16	5	2.5		22246
PASSAT	91-91	4	2.0		22300
PASSAT	02-04	8	4.0		22309
PASSAT CC	09-14	6	3.6		22266
PASSAT TURBO	06-08	4	2.0		22246
PASSAT TURBO	98-05	4	1.8		22280
PASSAT VR6	98-05	6	2.8		22280
POINTER	06-09	4	1.8		22266
POINTER	98-05	4	1.8		22308
POINTER GTI	00-03	4	2.0	22308	
POINTER PICK UP	99-02	4	1.8	22308	
POLO	03-07	4	1.6	22266	
POLO	03-07	4	2.0	22286	
ROUTAN	11-12	6	3.6	22365	
SAVEIRO	10-16	4	1.6	22266	
SEDAN	93-04	4	1.6	22300	
SHARAN TURBO	02-04	4	1.8	22280	
SPORT VAN	07-10	4	1.6	22266	
TOUAREG	09-14	6	3.6	22266	
TOUAREG	04-07	8	4.2	22280	
TOUAREG	04-06	6	3.2	22309	
VAN	07-09	4	1.8	22266	
VAN	03-06	4	1.8	22304	
VENTO	14-17	4	1.6	22266	

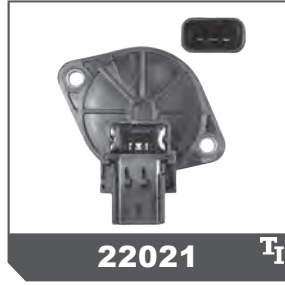

# SENSORES DE POSICIÓN DEL ÁRBOL DE LEVAS (CMP)

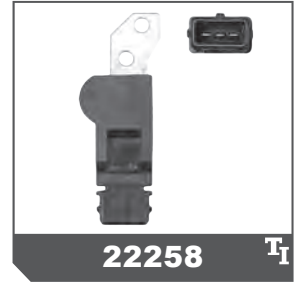
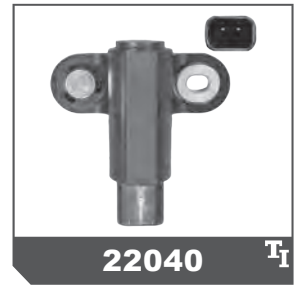
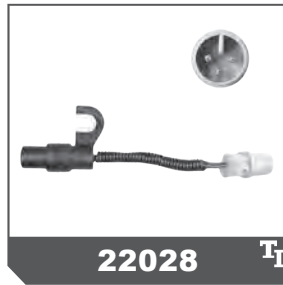

**SENSORES DE POSICIÓN DEL ÁRBOL DE LEVAS (CMP)**

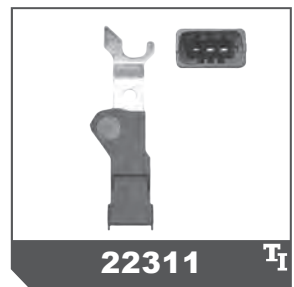
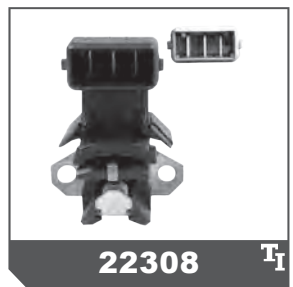

**SENSORES DE POSICIÓN DEL ÁRBOL DE LEVAS (CMP)**





**SENSORES DE POSICIÓN DEL ÁRBOL DE LEVAS (CMP)**



NUEVO

**SU FUNCIÓN:**

Indican la posición del cigüeñal al módulo de encendido. Esta información es usada para el tiempo de apertura de los inyectores y el tiempo de ignición.

**SÍNTOMAS DE FALLA:**

El vehículo no arranca, tarda en responder o produce explosiones en el arranque.

**MANTENIMIENTO/SERVICIO:**

Checar si hay códigos de falla y diagnosticar si es necesario.

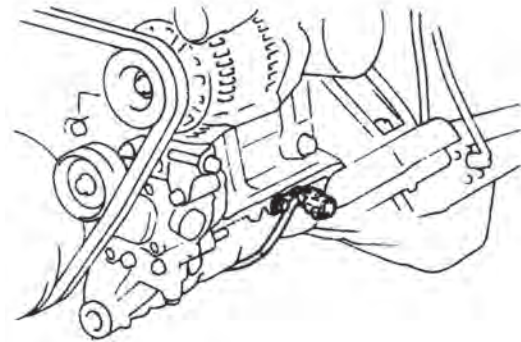

ACURA					
MODELO	AÑO	CIL.	MOTOR	SISTEMA	No. PARTE
RDX TURBO	07-12	4	2.3	MPFI	22371

AUDI					
MODELO	AÑO	CIL.	MOTOR	SISTEMA	No. PARTE
A3 QUATTRO	06-08	6	3.2	MPFI	22305
A3 TURBO	08-08	4	1.4		22305
A3 TURBO	02-02	4	1.8		22306
A3 TURBO	10-13	4	2.0		22394
A3 TURBO	05-08	4	2.0		22305
A4	02-05	6	3.0		22305
A4 QUATTRO T/A	02-05	6	3.0		22306
A4 QUATTRO T/M	02-05	6	3.0		22305
A4 QUATTRO TURBO	00-05	4	1.8		22306
A4 QUATTRO TURBO	05-09	4	2.0		22305
A4 QUATTRO VR6 T/M	98-01	6	2.8		22305
A4 QUATTRO VR6 T/A	98-01	6	2.8		22306
A4 TURBO	00-06	4	1.8		22306
A4 TURBO	05-09	4	2.0		22305
A4 TURBO	14-14	4	2.0		22394
A4 VR6 T/M	98-01	6	2.8		22305
A4 VR6 T/A	98-01	6	2.8		22306
A6	99-01	6	2.8		22306
A6	02-04	6	3.0		22305
A6 QUATTRO	02-04	6	3.0		22306
A6 QUATTRO BITURBO	00-04	6	2.7		22306
A6 QUATTRO VR6	00-01	6	2.8		22305
A6 QUATTRO VR6	99-99	6	2.8		22306
ALLROAD QUATTRO BITURBO	01-05	6	2.7		22306
Q7	07-10	6	3.6		22305
S3	08-08	4	2.0		22305
TT QUATTRO	04-06	6	3.2		22305
TT QUATTRO	08-09	6	3.2		22305
TT QUATTRO TURBO	01-06	4	1.8		22305
TT QUATTRO TURBO	00-00	4	1.8		22306
TT QUATTRO TURBO	09-11	4	2.0	22305	
TT QUATTRO TURBO	12-12	5	2.5	22415	
TT TURBO	04-06	4	1.8	22305	
TT TURBO	00-03	4	1.8	22306	
TT TURBO	07-08	4	2.0	22305	

BMW					
MODELO	AÑO	CIL.	MOTOR	SISTEMA	No. PARTE
320i	05-05	6	2.2	MPFI	22409
323i	98-01	6	2.5		22409
323is	98-99	6	2.5		22409
323ti	99-00	6	2.5		22409
325Ci	01-06	6	2.5		22409
325i	01-05	6	2.5		22409
328Ci	00-00	6	2.8		22409
328i	96-00	6	2.8		22409
328is	96-99	6	2.8		22409
330Ci	01-06	6	3.0		22409

BMW						
MODELO	AÑO	CIL.	MOTOR	SISTEMA	No. PARTE	
330i	01-05	6	3.0	MPFI	22409	
525i	01-03	6	2.5		22409	
528i	96-00	6	2.8		22409	
530i	01-05	6	3.0		22409	
X3	04-06	6	2.5		22409	
X3	04-06	6	3.0		22409	
X5	01-06	6	3.0		22409	
Z3	00-00	4	2.0		22409	
Z3	97-99	6	2.8		22409	
Z3	99-99	4	1.9		22409	
Z3	99-99	6	2.5		22409	
Z3	01-02	6	3.0		22409	
Z4	03-05	6	2.5		22409	

CHRYSLER						
MODELO	AÑO	CIL.	MOTOR	SISTEMA	No. PARTE	
200	12-14	4	2.4	MPFI	22327	
200	12-16	6	3.6		22363	
300	12-17	6	3.6		22363	
300C	07-10	6	3.5		22328	
300C	05-06	8	5.7		22350	
300C	05-06	6	3.5		22292	
300C SRT-8	06-06	8	6.1		22350	
300M	99-99	6	3.5		22291	
300M	00-04	6	3.5		22292	
CIRRUS	96-00	4	2.4		22145	
CIRRUS	03-06	4	2.4		22275	
CIRRUS	96-00	6	2.5		22290	
CIRRUS	07-07	4	2.4		22327	
CIRRUS	07-08	6	3.5		22328	
CIRRUS	08-10	4	2.4		22328	
CONCORDE	93-97	6	3.5		22291	
CROSSFIRE	04-06	6	3.2		22329	
GRAND VOYAGER	91-93	6	3.3		22011	
GRAND VOYAGER	95-97	6	3.8		22148	
GRAND VOYAGER	98-00	6	3.8		22395	
GRAND VOYAGER	01-02	6	3.8		22292	
NEW YORKER LH	94-96	6	3.5		22291	
PACIFICA	07-08	6	4.0		22328	
PACIFICA	04-06	6	3.5		22292	
PACIFICA	07-07	6	3.8		22292	
PT CRUISER	01-02	4	2.4		22145	
PT CRUISER	03-10	4	2.4		22275	
PT CRUISER TURBO	03-04	4	2.4		22275	
TOWN & COUNTRY	93-93	6	3.3		22011	
TOWN & COUNTRY	94-97	6	3.8		22148	
TOWN & COUNTRY	08-10	6	4.0	22328		
TOWN & COUNTRY	11-16	6	3.6	22363		
TOWN & COUNTRY	98-00	6	3.8	22395		
TOWN & COUNTRY	01-07	6	3.8	22292		
VOYAGER	91-93	6	3.3	22011		
VOYAGER	95-97	6	3.3	22148		

CONTINÚA»

CHRYSLER					
MODELO	AÑO	CIL.	MOTOR	SISTEMA	No. PARTE
VOYAGER	08-08	6	3.3	MPFI	22328
VOYAGER	98-00	6	3.3		22395
VOYAGER	01-07	6	3.3		22292

CHRYSLER			DODGE		
MODELO	AÑO	CIL.	MOTOR	SISTEMA	No. PARTE
ATOS	01-04	4	1.0	MPFI	22277
ATOS	05-12	4	1.1		22277
ATTITUDE	06-08	4	1.4		22270
ATTITUDE	12-14	4	1.6		22419
ATTITUDE	06-10	4	1.6		22270
AVENGER	08-14	4	2.4		22327
AVENGER	08-10	6	3.5		22328
CALIBER	07-09	4	1.8		22327
CALIBER	07-09	4	2.0		22327
CALIBER	07-12	4	2.4		22327
CHALLENGER	13-17	6	3.6		22363
CHARGER	06-06	6	3.5		22292
CHARGER	07-10	6	3.5		22328
CHARGER	11-13	6	3.6		22363
CHARGER R/T	06-06	8	5.7		22350
DAKOTA	05-12	6	3.7		22271
DAKOTA	07-07	8	4.7		22412
DURANGO	12-15	6	3.6		22363
DURANGO	00-07	8	4.7		22412
DURANGO	04-06	8	5.7		22350
DURANGO T/A	98-00	8	5.2		22138
DURANGO T/A	98-03	8	5.9		22138
GRAND CARAVAN	17-17	6	3.6		22363
H100 VAN	12-14	4	2.4		22411
H100 VAN DIESEL	10-14	4	2.5		22333
i10	12-14	4	1.1		22414
INTREPID	98-98	6	2.7		22291
INTREPID	98-99	6	3.2		22291
INTREPID	94-97	6	3.5		22291
JOURNEY	09-17	4	2.4		22327
JOURNEY R/T	09-10	6	3.5		22328
JOURNEY R/T	11-17	6	3.6		22363
NEON	03-05	4	2.0		22275
NEON	95-02	4	2.0		22145
NEON SRT-4	04-05	4	2.4		22275
NITRO	07-12	6	3.7		22271
NITRO R/T	07-09	6	4.0		22328
PROMASTER 1500	14-17	6	3.6		22363
PROMASTER 2500	14-17	6	3.6		22363
PROMASTER 3500	14-17	6	3.6		22363
RAM 1500	03-12	6	3.7		22271
RAM 1500	02-02	6	3.9		22271
RAM 1500 T/A	94-96	6	3.9		22142
RAM 1500 T/M	94-96	6	3.9		22144
RAM 1500 T/M	97-01	6	3.9		22139
RAM 1500 T/A	97-01	6	3.9	22138	
RAM 2500	94-96	8	5.2	22142	
RAM 2500	94-96	8	5.9	22142	
RAM 2500 T/A	97-02	8	5.2	22138	
RAM 2500 T/A	97-03	8	5.9	22138	
RAM 2500 T/M	94-96	8	5.2	22144	
RAM 2500 T/M	97-02	8	5.2	22139	
RAM 2500 T/M	94-96	8	5.9	22144	
RAM 2500 T/M	97-02	8	5.9	22139	
RAM 2500 SRT-10	05-06	10	8.3	22327	
RAM 3500	94-96	8	5.9	22142	
RAM 3500 T/A	97-02	8	5.9	22138	
RAM 3500 T/M	94-96	8	5.9	22144	
RAM 3500 T/M	97-02	8	5.9	22139	
RAM 4000	94-96	8	5.9	22142	

CHRYSLER			DODGE		
MODELO	AÑO	CIL.	MOTOR	SISTEMA	No. PARTE
RAM 4000 T/A	97-02	8	5.9	MPFI	22138
RAM 4000 T/M	01-01	8	5.9		22139
RAM 4000 T/M	94-96	8	5.9		22144
RAM VAN 1500 T/A	97-03	6	3.9		22138
RAM VAN 2500	96-98	8	5.2		22142
RAM VAN 2500 T/A	99-03	8	5.2		22138
RAM VAN 3500 T/A	97-03	8	5.9		22138
RAMCHARGER T/A	99-01	8	5.2		22139
RAMCHARGER T/A	91-93	8	5.9		22143
RAMCHARGER T/A	99-00	8	5.9		22139
STRATUS	06-06	4	2.0		22275
STRATUS	95-02	4	2.0		22145
STRATUS	01-05	4	2.4		22357
STRATUS	03-06	4	2.4		22275
STRATUS	95-02	4	2.4		22145
VAN 1000	08-09	4	2.4		22333
VERNA	04-06	4	1.5		22270
VERNA	04-06	4	1.6	22270	
VIPER	04-04	10	8.3	22292	

CHRYSLER			JEEP		
MODELO	AÑO	CIL.	MOTOR	SISTEMA	No. PARTE
CHEROKEE	14-15	6	3.2	MPFI	22363
CHEROKEE SPORT	98-01	6	4.0		22265
COMMANDER	06-06	8	5.7		22350
COMMANDER	06-07	8	4.7		22412
COMPASS	07-17	4	2.4		22327
GRAND CHEROKEE	97-98	8	5.2		22138
GRAND CHEROKEE	98-98	8	5.9		22138
GRAND CHEROKEE	94-96	8	5.2		22142
GRAND CHEROKEE	93-93	8	5.2		22143
GRAND CHEROKEE	97-04	6	4.0		22260
GRAND CHEROKEE	05-10	6	3.7		22271
GRAND CHEROKEE	05-06	8	5.7		22350
GRAND CHEROKEE	11-15	6	3.6		22363
GRAND CHEROKEE	93-96	6	4.0		22400
GRAND CHEROKEE	99-09	8	4.7		22412
GRAND CHEROKEE SRT-8	06-06	8	6.1		22350
LIBERTY	02-12	6	3.7		22271
PATRIOT	07-17	4	2.4		22327
WRANGLER	97-02	4	2.5		22164
WRANGLER	12-15	6	3.6		22363
WRANGLER	03-05	4	2.4		22417
WRANGLER T/A	98-01	6	4.0		22260
WRANGLER T/A	07-11	6	3.8		22328
WRANGLER T/M	98-04	6	4.0		22164
WRANGLER T/A	02-06	6	4.0	22292	
WRANGLER T/M	08-11	6	3.8	22292	

CHRYSLER			PLYMOUTH		
MODELO	AÑO	CIL.	MOTOR	SISTEMA	No. PARTE
BREEZE	96-96	4	2.0	MPFI	22145

FIAT					
MODELO	AÑO	CIL.	MOTOR	SISTEMA	No. PARTE
GRANDE PUNTO	07-09	4	1.4	MPFI	22396
PALIO	04-05	4	1.6		22288
PALIO ADVENTURE	04-05	4	1.6		22288

FORD					
MODELO	AÑO	CIL.	MOTOR	SISTEMA	No. PARTE
AEROSTAR	91-95	6	4.0	MPFI	22108

CONTINÚA»

<b>FORD</b>					
MODELO	AÑO	CIL.	MOTOR	SISTEMA	No. PARTE
AEROSTAR	95-95	6	3.0		22368
CONTOUR	95-97	4	2.0		22274
CONTOUR	95-00	6	2.5		22285
CONTOUR	98-00	4	2.0		22358
COURIER	01-12	4	1.6		22274
ECONOLINE E-150	04-14	8	4.6		22110
ECONOLINE E-150	97-03	6	4.2		22120
ECONOLINE E-250	99-04	8	5.4		22110
ECONOLINE E-250	97-03	6	4.2		22120
ECONOLINE E-350	97-06	8	5.4		22110
ECOSPORT	04-12	4	2.0		22340
EDGE	07-15	6	3.5		22378
ESCAPE	01-12	6	3.0		22285
ESCAPE	05-08	4	2.3		22340
ESCAPE	09-15	4	2.5		22420
ESCORT	97-00	4	2.0		22111
ESCORT	94-96	4	1.9		22111
ESCORT	98-01	4	2.0		22358
EXPEDITION	97-14	8	5.4		22110
EXPEDITION	97-04	8	4.6		22110
EXPLORER	91-97	6	4.0		22108
EXPLORER	02-10	8	4.6		22110
EXPLORER	97-04	6	4.0		22313
EXPLORER	96-01	8	5.0		22352
EXPLORER	11-15	6	3.5		22378
EXPLORER SPORT TRAC	07-10	8	4.6		22110
F-150	97-09	6	4.2		22120
F-150	97-97	6	4.9		22120
F-150	11-14	8	5.0		22377
F-150	10-14	6	3.7		22378
F-250	97-09	8	4.6		22110
F-250	96-97	8	5.0		22352
F-250	96-97	8	5.8		22352
F-350	96-98	8	5.0		22352
F-350	96-97	8	5.8		22352
F-350 SUPER DUTY	99-10	8	5.4		22110
F-450 SUPER DUTY	99-14	10	6.8		22110
F-550 SUPER DUTY	00-14	10	6.8		22110
FIESTA	03-07	4	1.6		22340
FIESTA <b>NUEVO</b>	08-17	4	1.6		22426
FIVE HUNDRED	05-07	6	3.0		22285
FOCUS	00-04	4	2.0		22274
FOCUS	05-11	4	2.0		22340
FOCUS SOHC	00-00	4	2.0		22111
FOCUS STATION WAGON	00-04	4	2.0		22274
FOCUS ZX3	00-04	4	2.0		22274
FREESTAR	04-07	6	4.2		22120
FUSION	06-12	6	3.0		22285
FUSION	06-09	4	2.3		22420
FUSION	10-15	4	2.5		22420
FUSION SPORT	10-12	6	3.5		22378
IKON	04-07	4	1.6		22274
KA	01-08	4	1.6		22274
LOBO	01-08	8	5.4		22110
LOBO	04-08	8	4.6		22110
MONDEO	01-07	4	2.0		22340
MUSTANG	96-10	8	4.6		22110
MUSTANG	05-05	6	4.0		22313
MUSTANG	11-15	8	5.0		22377
MUSTANG	11-15	6	3.7		22378
MUSTANG SHELBY GT	08-12	8	5.4		22110
RANGER	94-00	4	2.3		22284
RANGER	02-02	4	2.3		22285
RANGER	01-11	4	2.3		22340
THUNDERBIRD	95-96	8	4.6		22110
THUNDERBIRD SC	94-96	6	3.8		22120

MPFI

<b>FORD</b>					
MODELO	AÑO	CIL.	MOTOR	SISTEMA	No. PARTE
TRANSIT TDI	08-10	4	2.2		22340
WINDSTAR	95-03	6	3.8	MPFI	22120
RANGER	96-08	6	3.0		22368

<b>FORD</b>						<b>LINCOLN</b>					
MODELO	AÑO	CIL.	MOTOR	SISTEMA	No. PARTE	MODELO	AÑO	CIL.	MOTOR	SISTEMA	No. PARTE
AVIATOR	03-05	8	4.6		22110	MARK LT	06-08	8	5.4		22110
BLACKWOOD	03-03	8	5.4		22110	MKS	09-14	6	3.7		22378
MARK LT	06-08	8	5.4		22110	MKS TURBO	11-11	6	3.5		22378
MKS	09-14	6	3.7		22378	MKX	07-10	6	3.5	MPFI	22378
MKS TURBO	11-11	6	3.5		22378	MKX	11-15	6	3.7		22378
MKX	07-10	6	3.5		22378	MKZ	07-12	6	3.5		22378
MKX	11-15	6	3.7		22378	MKZ	13-14	6	3.7		22378
MKZ	07-12	6	3.5		22378	NAVIGATOR	98-14	8	5.4		22110
MKZ	13-14	6	3.7		22378	TOWN CAR	91-07	8	4.6		22110
NAVIGATOR	98-14	8	5.4		22110	ZEPHYR	06-06	6	3.0		22285
TOWN CAR	91-07	8	4.6		22110						
ZEPHYR	06-06	6	3.0		22285						

<b>FORD</b>						<b>MERCURY</b>					
MODELO	AÑO	CIL.	MOTOR	SISTEMA	No. PARTE	MODELO	AÑO	CIL.	MOTOR	SISTEMA	No. PARTE
COUGAR XR7	93-95	6	3.8		22120	GRAND MARQUIS	92-04	8	4.6		22110
GRAND MARQUIS	92-04	8	4.6		22110	MARINER	05-11	6	3.0		22285
MARINER	05-11	6	3.0		22285	MILAN	07-08	6	3.0		22285
MILAN	07-08	6	3.0		22285	MONTEGO	05-07	6	3.0	MPFI	22285
MONTEGO	05-07	6	3.0		22285	MYSTIQUE	95-95	4	2.0		22274
MYSTIQUE	95-95	4	2.0		22274	MYSTIQUE	95-00	6	2.5		22285
MYSTIQUE	95-00	6	2.5		22285	MYSTIQUE	98-00	4	2.0		22358
MYSTIQUE	98-00	4	2.0		22358	SABLE	96-99	6	3.0		22368
SABLE	96-99	6	3.0		22368						

<b>GENERAL MOTORS</b>						<b>BUICK</b>					
MODELO	AÑO	CIL.	MOTOR	SISTEMA	No. PARTE	MODELO	AÑO	CIL.	MOTOR	SISTEMA	No. PARTE
CENTURY	87-89	6	2.8		22102	ENCLAVE	10-15	6	3.6		22407
ENCLAVE	10-15	6	3.6		22407	LACROSSE	10-16	6	3.6	MPFI	22407
LACROSSE	10-16	6	3.6		22407	REGAL	94-96	6	3.8		22112
REGAL	94-96	6	3.8		22112	VERANO	14-16	4	2.4		22384
VERANO	14-16	4	2.4		22384	VERANO TURBO	13-16	4	2.0		22384
VERANO TURBO	13-16	4	2.0		22384						

<b>GENERAL MOTORS</b>						<b>CADILLAC</b>					
MODELO	AÑO	CIL.	MOTOR	SISTEMA	No. PARTE	MODELO	AÑO	CIL.	MOTOR	SISTEMA	No. PARTE
CTS	08-09	6	3.6		22362	CTS	10-13	6	3.0		22407
CTS	10-13	6	3.0		22407	CTS	10-13	6	3.6		22407
CTS	10-13	6	3.6		22407	DEVILLE INFERIOR	00-04	8	4.6		22199
DEVILLE INFERIOR	00-04	8	4.6		22199	ESCALADE	02-05	8	5.3		22262
ESCALADE	02-05	8	5.3		22262	ESCALADE	02-06	8	6.0		22262
ESCALADE	02-06	8	6.0		22262	ESCALADE ESV	03-06	8	6.0	MPFI	22262
ESCALADE ESV	03-06	8	6.0		22262	ESCALADE EXT	03-06	8	6.0		22262
ESCALADE EXT	03-06	8	6.0		22262	SEVILLE INFERIOR	00-04	8	4.6		22199
SEVILLE INFERIOR	00-04	8	4.6		22199	SRX	12-16	6	3.6		22407
SRX	12-16	6	3.6		22407	SRX	10-11	6	3.0		22407
SRX	10-11	6	3.0		22407	STS	08-09	6	3.6		22362
STS	08-09	6	3.6		22362	STS	10-10	6	3.6		22407
STS	10-10	6	3.6		22407						

<b>GENERAL MOTORS</b>						<b>CHEVROLET</b>					
MODELO	AÑO	CIL.	MOTOR	SISTEMA	No. PARTE	MODELO	AÑO	CIL.	MOTOR	SISTEMA	No. PARTE
ASTRA	00-03	4	1.8		22256	ASTRA	01-03	4	2.2		22279
ASTRA	01-03	4	2.2		22279	ASTRA	04-06	4	2.4		22310
ASTRA	04-06	4	2.4		22310	AVALANCHE	02-06	8	5.3		22262
AVALANCHE	02-06	8	5.3		22262	AVEO	08-17	4	1.6	MPFI	22334
AVEO	08-17	4	1.6		22334	BEAT	18-18	4	1.2		22257
BEAT	18-18	4	1.2		22257	BLAZER	95-01	6	4.3		22126
BLAZER	95-01	6	4.3		22126	C2500	96-98	8	5.0		22126
C2500	96-98	8	5.0		22126						

CONTINÚA»

GENERAL MOTORS		CHEVROLET					
MODELO	AÑO	CIL.	MOTOR	SISTEMA	No. PARTE		
C2500	96-00	8	5.7	MPFI	22126		
C3500	96-00	8	5.7		22126		
CAMARO	10-16	6	3.6		22407		
CAMARO	95-95	8	5.7		22102		
CAMARO	98-02	8	5.7		22262		
CAPTIVA SPORT	08-15	4	2.4		22384		
CAPTIVA SPORT	11-15	6	3.0		22407		
CAPTIVA SPORT	08-10	6	3.6		22362		
CAVALIER	95-96	4	2.2		22125		
CAVALIER	97-02	4	2.2		22278		
CAVALIER	90-94	6	2.8		22102		
CAVALIER Z24	95-97	4	2.4		22279		
CAVALIER Z24	91-94	6	3.1		22114		
CELEBRITY	87-89	6	2.8		22102		
CHEVY	96-03	4	1.4		TBI	22301	
CHEVY	09-12	4	1.6		MPFI	22312	
CHEVY	96-03	4	1.6			22301	
CHEVY	96-03	4	1.6		TBI	22301	
CHEVY C2	04-08	4	1.6		MPFI	22312	
CHEVY MONZA	96-03	4	1.6		TBI	22301	
CHEVY PICK UP	99-03	4	1.6	MPFI	22301		
CHEVY WAGON	00-03	4	1.6		22301		
COLORADO	15-15	6	3.6		22407		
COLORADO <b>NUEVO</b>	07-07	4	2.9		22425		
COLORADO <b>NUEVO</b>	04-06	5	3.5		22425		
COLORADO <b>NUEVO</b>	07-07	5	3.7		22425		
CORSA	03-08	4	1.8		22301		
CORVETTE	91-95	8	5.7		22102		
CORVETTE	97-04	8	5.7		22262		
CORVETTE	09-13	8	6.2		22262		
CRUZE	11-15	4	1.8		22416		
EQUINOX	05-06	6	3.4		22261		
EQUINOX	07-08	6	3.4		22264		
EXPRESS 1500	96-07	6	4.3		22126		
EXPRESS 1500	03-07	8	5.3		22262		
EXPRESS 2500	96-02	8	5.7		22126		
EXPRESS 3500	96-02	8	5.7		22126		
EXPRESS 3500	03-07	8	6.0		22262		
HHR	06-09	4	2.4		22384		
IMPALA	00-03	6	3.4		22102		
IMPALA	00-03	6	3.8	22112			
IMPALA DENTRO DEL CIGÜEÑAL	00-03	6	3.4	22296			
LUV	99-05	4	2.2	22310			
MALIBU	04-07	4	2.2	22279			
MALIBU	07-07	4	2.2	22384			
MALIBU	08-08	4	2.4	22279			
MALIBU	08-12	4	2.4	22384			
MALIBU	97-02	4	2.4	22279			
MALIBU	04-06	6	3.5	22261			
MALIBU	07-07	6	3.5	22264			
MALIBU	08-09	6	3.6	22362			
MALIBU	10-12	6	3.6	22407			
MALIBU TRASERO	97-03	6	3.1	22295			
MATIZ	11-15	4	1.0	22257			
MERIVA	04-06	4	1.8	22301			
OPTRA	06-10	4	2.0	22310			
P30	96-99	8	5.7	22126			
S10	95-95	4	2.2	22102			
S10	96-03	4	2.2	22278			
S10	96-96	4	2.2	22125			
SILVERADO 1500	07-11	6	4.3	22398			
SILVERADO 1500	13-13	6	4.3	22398			
SILVERADO 1500	99-07	6	4.3	22126			
SILVERADO 2500	00-10	8	4.8	22262			
SILVERADO 2500	03-09	8	5.3	22262			
SILVERADO 3500	99-06	8	5.7	22126			

GENERAL MOTORS		CHEVROLET				
MODELO	AÑO	CIL.	MOTOR	SISTEMA	No. PARTE	
SILVERADO 3500	01-07	8	6.0	MPFI	22262	
SILVERADO 3500 HD	01-06	8	8.1		22361	
SONIC	12-17	4	1.6		22416	
SPARK CLASSIC	11-17	4	1.2		22257	
SUBURBAN	96-99	8	5.7		22126	
SUBURBAN 1500	00-06	8	5.3		22262	
SUBURBAN 2500	00-06	8	6.0		22262	
TAHOE	07-09	8	5.3		22262	
TORNADO	12-16	4	1.8		22384	
TORNADO	04-11	4	1.8		22301	
TRACKER	99-06	4	2.0		22424	
TRAIL BLAZER	02-07	6	4.2		22279	
TRAIL BLAZER	06-06	8	5.3		22262	
TRAIL BLAZER EXT	02-06	6	4.2		22279	
TRAIL BLAZER EXT	03-06	8	5.3		22262	
TRAVERSE	10-15	6	3.6		22407	
TRAVERSE	09-09	6	3.6		22362	
TRAX	13-16	4	1.8		22416	
UPLANDER	05-06	6	3.5		22261	
UPLANDER	07-09	6	3.9		22264	
VECTRA	03-03	4	2.2	22278		
VECTRA	04-05	4	2.2	22279		
VENTURE	97-04	6	3.4	22102		
VENTURE TRASERO	97-04	6	3.4	22295		
ZAFIRA	02-05	4	2.2	22279		

GENERAL MOTORS		GMC				
MODELO	AÑO	CIL.	MOTOR	SISTEMA	No. PARTE	
ACADIA	07-10	6	3.6	MPFI	22362	
ACADIA	11-15	6	3.6		22407	
CANYON <b>NUEVO</b>	07-07	5	3.7		22425	
TERRAIN	11-12	6	3.0		22407	
TERRAIN	13-16	6	3.6		22407	

GENERAL MOTORS		HUMMER				
MODELO	AÑO	CIL.	MOTOR	SISTEMA	No. PARTE	
H2	05-07	8	6.0	MPFI	22262	
H3 <b>NUEVO</b>	06-06	5	3.5		22425	

GENERAL MOTORS		OLDSMOBILE				
MODELO	AÑO	CIL.	MOTOR	SISTEMA	No. PARTE	
88	93-95	6	3.8	MPFI	22112	
CUTLASS	89-95	6	3.1		22102	
SILHOUETTE	94-95	6	3.8		22112	

GENERAL MOTORS		PONTIAC				
MODELO	AÑO	CIL.	MOTOR	SISTEMA	No. PARTE	
AZTEK SUPERIOR	01-05	6	3.4	MPFI	22114	
AZTEK TRASERO	01-05	6	3.4		22295	
BONNEVILLE	94-99	6	3.8		22112	
G3	07-07	4	1.6		22334	
G4	05-05	4	2.2		22279	
G4	06-06	4	2.2		22384	
G4 GT	06-06	4	2.4		22384	
G5	07-09	4	2.2		22384	
G5 GT	07-09	4	2.4		22384	
G6	05-06	6	3.5		22261	
G6	07-09	6	3.5		22264	
G6	07-09	6	3.6		22362	
GRAND AM	99-04	6	3.4		22114	
GRAND AM TRASERO	99-04	6	3.4		22295	
GRAND PRIX	97-01	6	3.1		22296	
GRAND PRIX SC	97-01	6	3.8		22112	
MATIZ	04-10	4	1.0		22257	
MONTANA	05-06	6	3.5		22261	
MONTANA	06-09	6	3.9		22264	

CONTINÚA»



# SENSORES DE POSICIÓN DEL CIGÜEÑAL (CKP)

GENERAL MOTORS		PONTIAC			
MODELO	AÑO	CIL.	MOTOR	SISTEMA	No. PARTE
SOLSTICE	06-09	4	2.4	MPFI	22384
SUNFIRE	95-96	4	2.2		22125
SUNFIRE	97-02	4	2.2		22278
SUNFIRE	99-02	4	2.4		22279
SUNFIRE	03-05	4	2.2		22279
TORRENT	06-06	6	3.4		22261
TORRENT	07-09	6	3.4		22264

HONDA					
MODELO	AÑO	CIL.	MOTOR	SISTEMA	No. PARTE
ACCORD	98-02	6	3.0	MPFI	22317
ACCORD	98-02	4	2.3		22318
ACCORD	03-07	4	2.4		22371
CIVIC	97-00	4	1.6		22273
CIVIC	97-00	4	1.6		22319
CIVIC	06-11	4	1.8		22371
CIVIC	01-05	4	1.7		22375
CIVIC SI	07-11	4	2.0		22323
CR-V	02-09	4	2.4		22323
FIT	06-08	4	1.5		22371

HYUNDAI					
MODELO	AÑO	CIL.	MOTOR	SISTEMA	No. PARTE
ELANTRA	15-17	4	1.8	MPFI	22419

KIA					
MODELO	AÑO	CIL.	MOTOR	SISTEMA	No. PARTE
RIO	16-16	4	1.6	MPFI	22419

MAZDA					
MODELO	AÑO	CIL.	MOTOR	SISTEMA	No. PARTE
3	06-13	4	2.0	MPFI	22405
3	06-09	4	2.3		22405
3	10-13	4	2.5		22405
5	06-07	4	2.3		22340
5	08-10	4	2.3		22405
5	12-15	4	2.5		22405
6	06-08	6	3.0		22285
6	09-13	6	3.7		22378
6	06-08	4	2.3		22405
6	09-13	4	2.5		22405
CX-7	10-12	4	2.5		22405
CX-9	07-07	6	3.5		22378
CX-9	08-15	6	3.7		22378
MX-5 MIATA	06-14	4	2.0		22405

MERCEDES BENZ					
MODELO	AÑO	CIL.	MOTOR	SISTEMA	No. PARTE
C230	99-00	4	2.3	MPFI	22329
C230	97-98	4	2.3		22408
CLK320	98-99	6	3.2		22329
CLK430	99-00	8	4.3		22329
E320	98-99	6	3.2		22329
E320	96-96	6	3.2		22408
E420	97-97	8	4.2		22408
E430	00-00	8	4.3		22329
E55	00-00	8	5.5		22329
ML320	98-98	6	3.2		22329
ML430	99-99	8	4.3		22329
S420	96-99	8	4.2		22408
S430	00-00	8	4.3		22329
S500	00-00	8	5.0		22329
S500	96-99	8	5.0		22408
S600	96-98	12	6.0		22408
SL320	97-97	6	3.2		22408

MERCEDES BENZ					
MODELO	AÑO	CIL.	MOTOR	SISTEMA	No. PARTE
SL500	96-98	8	5.0	MPFI	22408
SL60 AMG	98-98	8	6.0		22408
SL600	00-00	12	6.0		22329
SL600	96-02	12	6.0		22408
SLK230	98-98	4	2.3		22408
SPRINTER CDI	04-06	5	2.7		22329

MITSUBISHI					
MODELO	AÑO	CIL.	MOTOR	SISTEMA	No. PARTE
GALANT	04-04	4	2.4	MPFI	22357
GALANT	05-09	4	2.4		22410
GRANDIS	07-09	4	2.4		22410
LANCER	04-07	4	2.0		22413
LANCER	08-15	4	2.0		22418
LANCER GTS	09-15	4	2.4		22418
LANCER RALLIART	05-06	4	2.4		22410
OUTLANDER	04-06	4	2.4		22410
OUTLANDER	08-15	4	2.4		22418
OUTLANDER	16-17	4	2.4		22418

NISSAN		INFINITI			
MODELO	AÑO	CIL.	MOTOR	SISTEMA	No. PARTE
FX35	12-12	6	3.5	MPFI	22374
FX37	13-13	6	3.7		22374
G37	12-13	6	3.7		22374
I30 DERECHO	98-01	6	3.0		22355
I30 IZQUIERDO	98-01	6	3.0		22337
Q60	14-14	6	3.7		22374
Q70	14-14	6	3.7		22374

NISSAN					
MODELO	AÑO	CIL.	MOTOR	SISTEMA	No. PARTE
240SX	98-98	4	2.4	MPFI	22422
300SX	96-96	6	3.0		22422
350Z	07-08	6	3.5		22374
350Z	03-06	6	3.5		22250
370Z	09-15	6	3.7		22374
ALMERA	01-05	4	1.8		22299
ALTIMA	98-01	4	2.4		22331
ALTIMA	07-16	4	2.5		22374
ALTIMA	07-16	6	3.5		22374
ALTIMA	02-06	4	2.5		22250
ALTIMA	96-97	4	2.4		22356
ALTIMA T/A	04-06	6	3.5		22421
ALTIMA 2 PIEZAS	02-06	4	2.5		22282
ALTIMA T/M	02-06	6	3.5		22250
D21	98-08	4	2.4		22230
D21	95-97	4	2.4		22353
FRONTIER	01-04	4	2.4		22230
FRONTIER	01-04	6	3.3		22230
FRONTIER	08-14	6	4.0		22250
MARCH	12-18	4	1.6		22373
MAXIMA	09-15	6	3.5		22374
MAXIMA	03-08	6	3.5		22250
MAXIMA T/A	03-06	6	3.5		22421
MAXIMA FRONTAL	95-01	6	3.0		22355
MAXIMA FRONTAL	02-02	6	3.5		22355
MAXIMA TRASERO	95-01	6	3.0		22337
MAXIMA TRASERO	02-02	6	3.5		22337
MURANO	09-14	6	3.5		22374
MURANO	04-08	6	3.5		22250
NP300	09-15	4	2.4		22230
NP300 TDI	09-12	4	2.5		22250
NP300 TDI 2 PIEZAS	09-12	4	2.5	22282	
PATHFINDER	97-00	6	3.3	22353	
PATHFINDER	01-02	6	3.5	22355	

CONTINÚA»



<b>NISSAN</b>						
MODELO	AÑO	CIL.	MOTOR	SISTEMA	No. PARTE	
PATHFINDER	13-16	6	3.5		22374	
PATHFINDER	03-04	6	3.5		22250	
PATHFINDER	05-12	6	4.0		22250	
PLATINA T/A	02-10	4	1.6		22248	
PLATINA T/M	02-10	4	1.6		22276	
QUEST	97-98	6	3.0		22356	
QUEST	99-02	6	3.3		22356	
QUEST	04-06	6	3.5		22250	
QUEST 5 VEL. (HASTA 06)	04-09	6	3.5		22421	
ROGUE	08-14	4	2.5		22374	
SENTRA	96-99	4	1.6		22422	
SENTRA	96-97	4	2.0		22422	
SENTRA	07-12	4	2.0		22373	
SENTRA	01-06	4	1.8		22299	
SENTRA T/A	98-01	4	2.0		22354	
SENTRA T/M	98-01	4	2.0	MPFI	22423	
SENTRA SE-R	07-12	4	2.5		22374	
SENTRA SE-R	02-06	4	2.5		22250	
SENTRA SE-R 2 PIEZAS	02-06	4	2.5		22282	
TIIDA	13-18	4	1.6		22373	
TIIDA	07-18	4	1.8		22373	
URVAN	02-07	4	2.4		22230	
URVAN	08-13	4	2.5		22250	
URVAN 2 PIEZAS	08-13	4	2.5		22282	
VERSA	12-18	4	1.6		22373	
XTERRA	00-04	4	2.4		22230	
XTERRA	00-04	6	3.3		22230	
XTERRA	05-07	6	4.0		22250	
X-TRAIL	08-14	4	2.5		22374	
X-TRAIL	02-07	4	2.5		22250	
X-TRAIL 2 PIEZAS	02-07	4	2.5		22282	

<b>PEUGEOT</b>						
MODELO	AÑO	CIL.	MOTOR	SISTEMA	No. PARTE	
206	03-07	4	1.4		22322	
206	03-07	4	1.6		22322	
307	03-05	4	2.0		22320	
307	06-08	4	2.0		22321	
406	00-05	4	2.0	MPFI	22320	
407	06-09	4	2.2		22341	
407	06-08	6	3.0		22341	
206 T/A	03-07	4	1.4		22389	
206 T/A	03-07	4	1.6		22389	

<b>RENAULT</b>						
MODELO	AÑO	CIL.	MOTOR	SISTEMA	No. PARTE	
CLIO T/A	02-10	4	1.6		22248	
CLIO T/M	02-10	4	1.6		22276	
CLIO SPORT T/A	02-06	4	2.0		22248	
CLIO SPORT T/M	02-06	4	2.0		22276	
KANGOO T/M	04-14	4	1.6		22276	
MEGANE T/A	01-03	4	2.0		22248	
MEGANE T/M	01-03	4	2.0	MPFI	22276	
MEGANE II T/A	04-10	4	2.0		22248	
MEGANE II T/M	04-10	4	2.0		22276	
MEGANE II T/M	08-10	4	1.6		22276	
SCALA	11-13	4	1.6		22299	
SCENIC T/A	01-05	4	2.0		22248	
SCENIC T/M	01-05	4	2.0		22276	

<b>SEAT</b>						
MODELO	AÑO	CIL.	MOTOR	SISTEMA	No. PARTE	
CORDOBA	01-04	4	2.0		22306	
IBIZA	03-08	4	1.6	MPFI	22305	
IBIZA	03-15	4	2.0		22305	
IBIZA	01-02	4	1.6		22306	

<b>SEAT</b>						
MODELO	AÑO	CIL.	MOTOR	SISTEMA	No. PARTE	
LEON FR	07-11	4	2.0		22305	
LEON TURBO	02-06	4	1.8	MPFI	22305	
LEON TURBO	01-02	4	1.8		22306	
TOLEDO TURBO	02-03	4	1.8		22305	

<b>SUZUKI</b>						
MODELO	AÑO	CIL.	MOTOR	SISTEMA	No. PARTE	
AERIO	06-07	4	2.3		22424	
GRAND VITARA	09-09	6	3.2		22362	
GRAND VITARA	10-10	6	3.2	MPFI	22407	
SX4	08-09	4	2.0		22424	
XL-7	07-09	6	3.6		22362	

<b>TOYOTA</b>						
MODELO	AÑO	CIL.	MOTOR	SISTEMA	No. PARTE	
4RUNNER	06-09	6	4.0		22388	
4RUNNER	03-09	8	4.7		22392	
CAMRY	10-16	4	2.5		22383	
CAMRY	02-11	4	2.4		22385	
CAMRY	02-06	6	3.0		22387	
CAMRY	07-16	6	3.5		22388	
COROLLA	09-16	4	1.8		22383	
COROLLA	03-08	4	1.8		22386	
COROLLA XRS	11-11	4	2.4		22383	
COROLLA XRS	09-10	4	2.4		22385	
FJ CRUISER	08-14	6	4.0		22388	
HIACE <b>NUEVO</b>	06-08	4	2.7		22427	
HIGHLANDER	08-16	6	3.5		22388	
HILUX <b>NUEVO</b>	06-06	4	2.7		22427	
LAND CRUISER	04-07	8	4.7		22392	
MATRIX	09-10	4	1.8	MPFI	22383	
MATRIX	09-10	4	2.4		22385	
MATRIX	03-08	4	1.8		22386	
MR2 SPYDER	05-05	4	1.8		22386	
PRIUS HIBRIDO	10-16	4	1.8		22383	
RAV4	09-17	4	2.5		22383	
RAV4	04-08	4	2.4		22385	
RAV4	09-12	6	3.5		22388	
SEQUOIA	08-09	8	4.7		22392	
SIENNA	04-06	6	3.3		22387	
SIENNA	07-16	6	3.5		22388	
SOLARA	05-06	6	3.3		22387	
TACOMA	06-15	6	4.0		22388	
TUNDRA	07-07	6	4.0		22388	
TUNDRA	07-09	8	4.7		22392	
YARIS	06-17	4	1.5		22339	

<b>VOLKSWAGEN</b>						
MODELO	AÑO	CIL.	MOTOR	SISTEMA	No. PARTE	
BEETLE	01-05	4	2.0		22305	
BEETLE	99-01	4	2.0		22306	
BEETLE	06-09	4	2.0		22415	
BEETLE	06-16	5	2.5		22415	
BEETLE TURBO	02-05	4	1.8		22305	
BEETLE TURBO	99-01	4	1.8		22306	
BORA	06-10	5	2.5		22415	
BORA GLI	06-10	4	2.0		22305	
BORA TDI	08-10	4	1.9	MPFI	22393	
CRAFTER TDI	08-08	5	2.5		22393	
CROSSFOX	11-17	4	1.6		22394	
CROSSFOX	07-09	4	1.6		22394	
DERBY	01-02	4	2.0		22194	
DERBY	03-08	4	1.8		22366	
EUROVAN	02-04	5	2.5		22305	
EUROVAN VR6	01-04	6	2.8		22306	
GOL	09-17	4	1.6		22394	

CONTINÚA»

# SENSORES DE POSICIÓN DEL CIGÜEÑAL (CKP)

VOLKSWAGEN					
MODELO	AÑO	CIL.	MOTOR	SISTEMA	No. PARTE
GOLF A3	93-97	4	2.0	MPFI	22194
GOLF A3 VR6	96-99	6	2.8		22194
GOLF A3 VR6	95-95	6	2.8		22401
GOLF A4	00-06	4	2.0		22305
GOLF A4 GTI	02-05	4	1.8		22305
GOLF A4 GTI	00-01	4	1.8		22306
GOLF A4 R32	04-04	6	3.2		22305
GOLF A5 GTI	07-08	4	2.0		22305
GOLF A5 SPORT WAGEN	10-13	5	2.5		22415
JETTA A3	93-99	4	2.0		22194
JETTA A3	97-98	4	1.8		22194
JETTA A3 VR6	96-98	6	2.8		22194
JETTA A3 VR6	95-95	6	2.8		22401
JETTA A4	01-10	4	2.0		22305
JETTA A4	99-00	4	2.0		22306
JETTA A4 CLASICO	10-15	4	2.0		22305
JETTA A4 TDI	06-06	4	1.9		22393
JETTA A4 TURBO	02-05	4	1.8		22305
JETTA A4 TURBO	99-01	4	1.8		22306
JETTA A4 VR6	03-04	6	2.8		22305
JETTA A4 VR6	99-02	6	2.8		22306
JETTA A6	11-16	5	2.5		22415
LUPO	05-09	4	1.6		22394
PASSAT	06-08	6	3.6		22305
PASSAT	12-16	5	2.5		22415
PASSAT CC	09-11	6	3.6		22305
PASSAT TURBO	06-08	4	2.0		22305
PASSAT TURBO	00-05	4	1.8		22306
PASSAT VR6	95-97	6	2.8		22194
PASSAT VR6 T/A	98-05	6	2.8		22306
PASSAT VR6 T/M	98-05	6	2.8		22305
POINTER	04-06	4	1.8		22366
POLO	03-07	4	2.0		22306
ROUTAN	09-10	6	3.8	22328	
SHARAN TURBO	02-04	4	1.8	22306	
SPORT VAN	07-10	4	1.6	22394	
TOUAREG	04-06	6	3.2	22305	
TOUAREG	08-10	6	3.6	22305	
VAN	06-09	4	1.8	22366	
VENTO	14-17	4	1.6	22394	

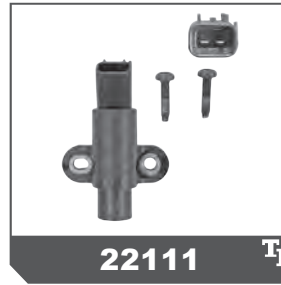

**SENSORES DE POSICIÓN DEL CIGÜEÑAL (CKP)**

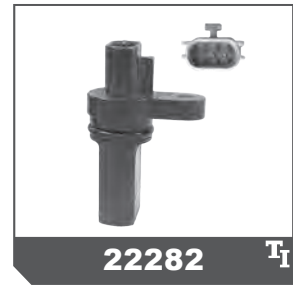
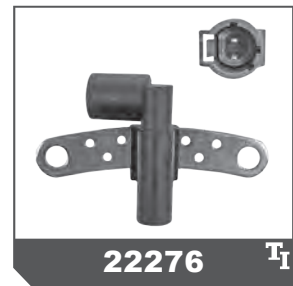
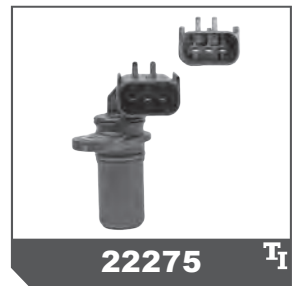
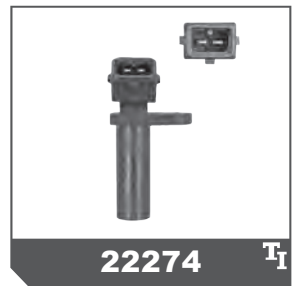
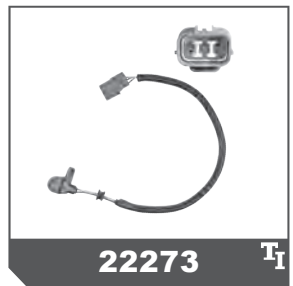
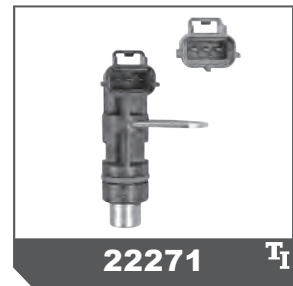
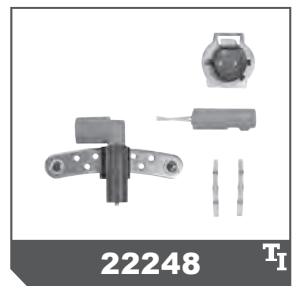
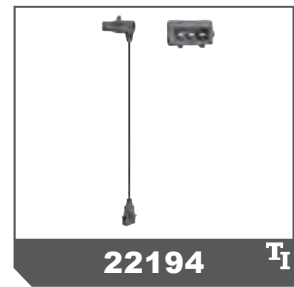

# SENSORES DE POSICIÓN DEL CIGÜEÑAL (CKP)

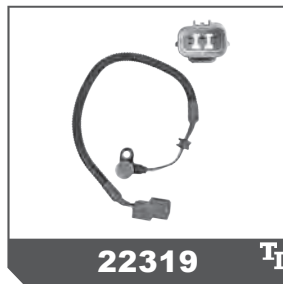
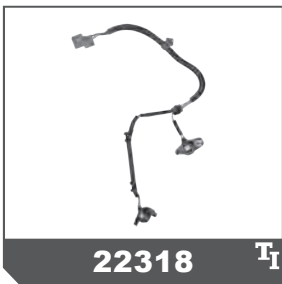
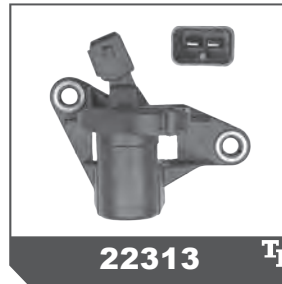
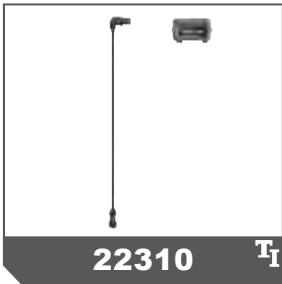
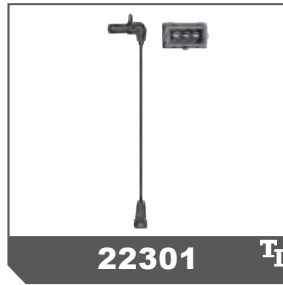
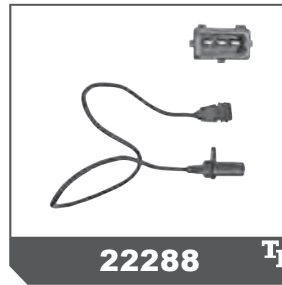

**SENSORES DE POSICIÓN DEL CIGÜEÑAL (CKP)**

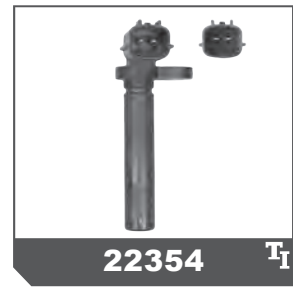
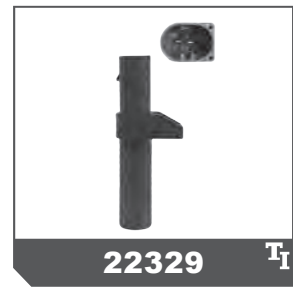

# SENSORES DE POSICIÓN DEL CIGÜEÑAL (CKP)





**SENSORES DE POSICIÓN DEL CIGÜEÑAL (CKP)**

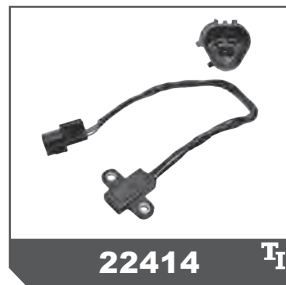

NUEVO

NUEVO

NUEVO

**SENSORES DE POSICIÓN PARA VÁLVULA EGR (EVP)**

<b>FORD</b>					
MODELO	AÑO	CIL.	MOTOR	SISTEMA	No. PARTE
THUNDERBIRD SIN FILTRO	91-93	8	5.0	MPFI	14000
THUNDERBIRD CON FILTRO	91-93	8	5.0		14005

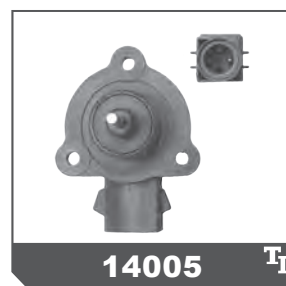
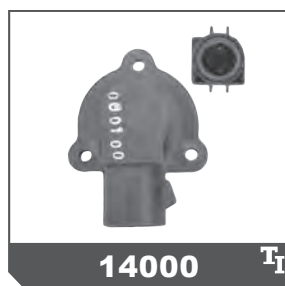

### SU FUNCIÓN:

Mandar a la computadora la señal de los cambios en la presión que existe dentro del múltiple de admisión, de manera que la computadora pueda controlar la ignición y el abastecimiento de combustible en diversas condiciones de altitud y carga del motor.

### SÍNTOMAS DE FALLA:

Mal funcionamiento del motor, expulsión de humo negro, el vehículo se detiene, jaloneo y sobrecalentamiento del convertidor catalítico.

### MANTENIMIENTO/SERVICIO:

Inspeccionar en cada afinación en los 40,000-50,000 kms. Checar si hay mangueras sueltas, rotas o tapadas. Revisar si hay corrosión en las terminales o cables rotos.

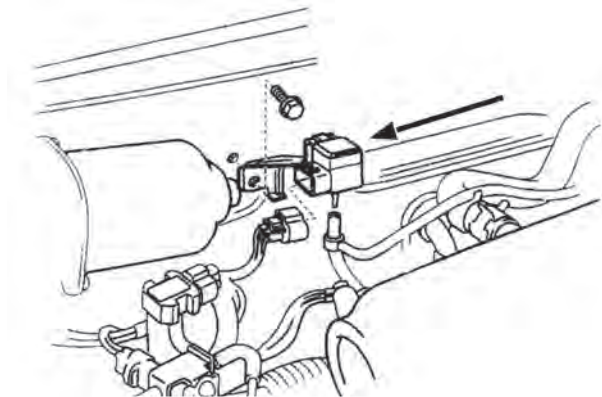

ACURA						
MODELO	AÑO	CIL.	MOTOR	SISTEMA	No. PARTE	
ILX	13-15	4	2.0	MPFI	18235	
ILX	16-16	4	2.4		18235	
MDX	05-06	6	3.5		18031	
MDX	07-13	6	3.7		18235	
MDX	14-16	6	3.5		18235	
RDX	13-17	6	3.5		18235	
RL	09-10	6	3.7		18235	
RLX	14-15	6	3.5		18235	
TL	09-13	6	3.5		18235	
TL	09-13	6	3.7		18235	
TSX	09-13	4	2.4		18235	
TSX	10-13	6	3.5		18235	
ZDX	10-11	6	3.7		18235	

AUDI						
MODELO	AÑO	CIL.	MOTOR	SISTEMA	No. PARTE	
S5	11-12	8	4.2	MPFI	18219	
S5 TURBO	10-14	6	3.0		18219	
SQ5 TURBO	14-14	6	3.0		18219	
TT QUATTRO MOTOR CCTA	09-10	4	2.0		18216	
TT QUATTRO MOTOR CDMA	09-14	4	2.0		18225	
TT QUATTRO TURBO	00-03	4	1.8		18206	
TT QUATTRO TURBO	04-06	4	1.8		18216	
TT QUATTRO TURBO	12-13	5	2.5		18225	
TT TURBO	00-03	4	1.8		18206	
TT TURBO	04-06	4	1.8		18216	
TT TURBO	07-09	4	2.0		18216	

AUDI						
MODELO	AÑO	CIL.	MOTOR	SISTEMA	No. PARTE	
A3 QUATTRO TURBO	09-13	4	2.0	MPFI	18216	
A3 TURBO	06-13	4	2.0		18216	
A3 TURBO	08-09	4	1.4		18216	
A3 TURBO	11-11	4	1.4		18216	
A3 TURBO	08-09	4	1.8		18216	
A3 TURBO	11-11	4	1.8		18216	
A4	06-08	6	3.2		18219	
A4 QUATTRO	05-09	6	3.2		18219	
A4 QUATTRO TURBO	00-01	4	1.8		18206	
A4 QUATTRO TURBO	02-05	4	1.8		18216	
A4 QUATTRO TURBO	05-09	4	2.0		18216	
A4 TURBO	00-01	4	1.8		18206	
A4 TURBO	02-06	4	1.8		18216	
A4 TURBO	05-09	4	2.0		18216	
A5 QUATTRO	08-10	6	3.2		18219	
A6	06-09	6	3.2		18219	
A6	05-05	6	3.0		18219	
A6	11-11	6	2.8		18219	
A6 QUATTRO	09-11	6	3.0		18219	
A6 QUATTRO	05-08	6	3.2		18219	
A7 QUATTRO TURBO	12-14	6	3.0		18219	
A8 QUATTRO	11-12	8	4.2		18219	
A8 QUATTRO	12-12	12	6.3		18219	
A8 QUATTRO TURBO	12-14	6	3.0		18219	
Q5	10-13	6	3.2		18219	
Q5 TURBO	13-14	6	3.0		18219	
Q7 TDI	09-14	6	3.0		18225	
Q7 TURBO	11-15	6	3.0		18219	
RS5	13-14	8	4.2		18219	
S4 TURBO	10-14	6	3.0		18219	

BMW						
MODELO	AÑO	CIL.	MOTOR	SISTEMA	No. PARTE	
120i	05-12	4	2.0	MPFI	18217	
320i	01-05	6	2.2		18217	
330i	01-06	6	3.0		18217	

CHRYSLER						
MODELO	AÑO	CIL.	MOTOR	SISTEMA	No. PARTE	
200	12-16	6	3.6	MPFI	18221	
200	12-14	4	2.4		18244	
300	12-17	6	3.6		18221	
300	12-15	8	5.7		18243	
300 SRT-8	12-14	8	6.4		18244	
300C	05-10	6	3.5		18243	
300C	05-10	8	5.7		18243	
300C SRT-8	06-08	8	6.1		18211	
300M	99-01	6	3.5		18060	
300M	02-04	6	3.5		18207	
ASPEN	08-09	8	5.7		18243	
ASPEN	07-07	8	5.7		18244	
CIRRUS	96-00	6	2.5		18054	
CIRRUS	96-00	4	2.4		18054	
CONCORDE	93-97	6	3.5		18028	
CONCORDE	02-02	6	3.5		18207	
GRAND VOYAGER	91-93	6	3.3		18028	
GRAND VOYAGER	94-95	6	3.8		18028	
GRAND VOYAGER	96-00	6	3.8		18054	
LEBARON K	85-86	4	2.2		18022	
LEBARON TURBO	92-94	4	2.5		18030	
NEW YORKER K	85-86	4	2.2		18022	
NEW YORKER LH	94-96	6	3.5		18028	
NEW YORKER TURBO	91-94	4	2.5		18030	
PACIFICA	04-05	6	3.5		18207	
PACIFICA	05-06	6	3.5		18215	

CONTINÚA»

CHRYSLER					
MODELO	AÑO	CIL.	MOTOR	SISTEMA	No. PARTE
PACIFICA	07-07	6	3.8	MPFI	18244
PACIFICA	07-07	6	4.0		18244
PHANTOM TURBO	90-94	4	2.5		18030
PT CRUISER	01-02	4	2.4		18200
PT CRUISER	03-10	4	2.4		18215
PT CRUISER TURBO	03-07	4	2.4		18238
TOWN & COUNTRY	93-93	6	3.3		18028
TOWN & COUNTRY	94-95	6	3.8		18028
TOWN & COUNTRY	96-00	6	3.8		18054
TOWN & COUNTRY	01-03	6	3.8		18205
TOWN & COUNTRY	04-07	6	3.8		18211
TOWN & COUNTRY	11-16	6	3.6		18221
TOWN & COUNTRY	08-10	6	4.0		18243
VOYAGER	98-98	6	3.3		18026
VOYAGER	94-95	6	3.3		18028
VOYAGER	99-00	6	3.3		18054
VOYAGER	96-97	6	3.3		18054
VOYAGER	01-03	6	3.3	18205	
VOYAGER	05-07	6	3.3	18211	

CHRYSLER						DODGE						
MODELO	AÑO	CIL.	MOTOR	SISTEMA	No. PARTE	MODELO	AÑO	CIL.	MOTOR	SISTEMA	No. PARTE	
ATOS	01-04	4	1.0	MPFI	18202							
ATOS	05-12	4	1.1		18202							
ATTITUDE	06-08	4	1.4		18202							
ATTITUDE	12-14	4	1.6		18230							
ATTITUDE	06-08	4	1.6		18202							
AVENGER	11-14	4	2.4		18244							
AVENGER	08-10	4	2.4		18243							
AVENGER	08-10	6	3.5		18243							
CALIBER	07-07	4	1.8		18244							
CALIBER	09-09	4	1.8		18243							
CALIBER	07-08	4	2.0		18244							
CALIBER	09-09	4	2.0		18243							
CALIBER	07-08	4	2.4		18244							
CALIBER	09-09	4	2.4		18243							
CALIBER	10-12	4	2.4		18244							
CHALLENGER	13-15	6	3.6		18221							
CHALLENGER R/T	09-14	8	5.7		18243							
CHALLENGER SRT-8	08-10	8	6.1	18211								
CHALLENGER SRT-8	11-15	8	6.4	18244								
CHARGER	06-10	6	3.5	18243								
CHARGER	13-13	6	3.6	18221								
CHARGER R/T	06-15	8	5.7	18243								
CHARGER SRT-8	07-10	8	6.1	18211								
CHARGER SRT-8	12-14	8	6.4	18244								
DAKOTA	05-10	6	3.7	18211								
DAKOTA	11-12	6	3.7	18211								
DAKOTA	07-07	8	4.7	18211								
DART	13-13	4	2.0	18243								
DART	14-15	4	2.4	18243								
DURANGO	12-15	6	3.6	18221								
DURANGO	01-01	8	4.7	18233								
DURANGO	04-05	8	4.7	18205								
DURANGO	02-09	8	4.7	18211								
DURANGO	98-00	8	5.2	18091								
DURANGO	04-15	8	5.7	18243								
DURANGO	98-03	8	5.9	18091								
GRAND CARAVAN	17-17	6	3.6	18221								
H100 VAN	12-14	4	2.4	18230								
i10	12-14	4	1.1	18230								
INTREPID	98-01	6	3.2	18060								
INTREPID	00-01	6	3.5	18060								
INTREPID	94-97	6	3.5	18028								
JOURNEY	11-17	4	2.4	18244								
JOURNEY	09-10	4	2.4	18243								

CHRYSLER						DODGE							
MODELO	AÑO	CIL.	MOTOR	SISTEMA	No. PARTE	MODELO	AÑO	CIL.	MOTOR	SISTEMA	No. PARTE		
JOURNEY R/T	09-10	6	3.5	MPFI	18243								
JOURNEY R/T	11-17	6	3.6		18221								
MAGNUM K	85-86	4	2.2		18022								
MICROBUS	91-94	8	5.9		TBI	18026							
NEON	01-02	4	2.0		MPFI	18200							
NEON	03-05	4	2.0			18215							
NEON	00-00	4	2.0			18054							
NEON	95-95	4	2.0			18054							
NEON	96-99	4	2.0			18060							
NEON SRT-4	04-05	4	2.4			18238							
NITRO	07-12	6	3.7			18211							
NITRO R/T	07-09	6	4.0			18243							
PROMASTER 1500	14-15	6	3.6			18221							
PROMASTER 2500	14-17	6	3.6			18221							
PROMASTER 3500	14-17	6	3.6			18221							
RAM 1500	14-15	6	3.6			18221							
RAM 1500	02-03	6	3.7			18205							
RAM 1500	04-13	6	3.7	18211									
RAM 1500	02-02	6	3.9	18205									
RAM 1500	97-01	6	3.9	18091									
RAM 2500	02-04	8	4.7	18205									
RAM 2500	94-96	8	5.2	18027									
RAM 2500	99-03	8	5.2	18091									
RAM 2500	03-05	8	5.7	18243									
RAM 2500	10-14	8	5.7	18243									
RAM 2500	94-96	8	5.9	18027									
RAM 2500	97-02	8	5.9	18091									
RAM 3500	94-96	8	5.9	18027									
RAM 3500	97-02	8	5.9	18091									
RAM 4000	95-96	8	5.9	18027									
RAM VAN 1500	99-03	6	3.9	18091									
RAM VAN 2500	99-03	8	5.2	18091									
RAM VAN 3500	99-03	8	5.9	18091									
RAMCHARGER	91-94	8	5.9	TBI	18026								
RAMCHARGER	92-93	8	5.9	18027									
SHADOW	91-94	4	2.5	18026									
SHADOW TURBO	91-94	4	2.5	18030									
SPIRIT	91-95	4	2.5	18026									
SPIRIT R/T	91-94	4	2.5	18030									
STRATUS	01-06	4	2.0	18200									
STRATUS	95-97	4	2.0	18054									
STRATUS	98-00	4	2.0	18060									
STRATUS	01-02	4	2.4	18200									
STRATUS	03-06	4	2.4	18215									
STRATUS	95-00	4	2.4	18054									
STRATUS R/T	95-99	4	2.4	18030									
VERNA	04-06	4	1.5	18202									
VERNA	04-06	4	1.6	18202									
VIPER SRT	13-14	10	8.4	18244									
VIPER SRT-10	10-10	10	8.4	18244									

CHRYSLER						JEEP						
MODELO	AÑO	CIL.	MOTOR	SISTEMA	No. PARTE	MODELO	AÑO	CIL.	MOTOR	SISTEMA	No. PARTE	
CHEROKEE	14-17	6	3.2	MPFI	18221							
CHEROKEE	14-15	4	2.4		18243							
CHEROKEE SPORT	94-94	6	4.0		18000							
CHEROKEE SPORT	98-01	6	4.0		18091							
COMMANDER	06-07	8	4.7		18211							
COMMANDER	06-10	8	5.7		18243							
COMPASS	07-17	4	2.4		18244							
GRAND CHEROKEE	93-96	8	5.2		18027							
GRAND CHEROKEE	97-03	6	4.0		18091							
GRAND CHEROKEE	97-98	8	5.2		18091							
GRAND CHEROKEE	98-98	8	5.9		18091							
GRAND CHEROKEE	93-95	6	4.0		18095							
GRAND CHEROKEE	02-04	8	4.7		18205							

# SENSORES DE PRESIÓN ABSOLUTA DEL MÚLTIPLE (MAP)

CHRYSLER		JEEP			
MODELO	AÑO	CIL.	MOTOR	SISTEMA	No. PARTE
GRAND CHEROKEE	05-10	6	3.7	MPFI	18211
GRAND CHEROKEE	05-09	8	4.7		18211
GRAND CHEROKEE	11-16	6	3.6		18221
GRAND CHEROKEE	99-01	8	4.7		18233
GRAND CHEROKEE	05-15	8	5.7		18243
GRAND CHEROKEE	16-16	8	5.7		18244
GRAND CHEROKEE	96-96	6	4.0		18245
GRAND CHEROKEE SRT-8	08-10	8	6.1		18211
GRAND CHEROKEE SRT-8	06-07	8	6.1		18243
GRAND CHEROKEE SRT-8	12-15	8	6.4		18244
LIBERTY	02-04	6	3.7		18205
LIBERTY	04-13	6	3.7		18211
PATRIOT	07-17	4	2.4		18244
WRANGLER	94-95	4	2.5		18000
WRANGLER	97-02	4	2.5		18091
WRANGLER	98-02	6	4.0		18091
WRANGLER	03-04	4	2.4		18205
WRANGLER	05-06	4	2.4		18211
WRANGLER	12-17	6	3.6	18221	
WRANGLER	07-11	6	3.8	18243	

FIAT					
MODELO	AÑO	CIL.	MOTOR	SISTEMA	No. PARTE
500	09-15	4	1.4	MPFI	18229
GRANDE PUNTO	07-09	4	1.4		18231
PALIO	04-05	4	1.6		18228
PALIO	06-08	4	1.8		18229
PALIO ADVENTURE	04-05	4	1.6		18228
PANDA	07-12	4	1.2		18229
UNO	13-17	4	1.4		18229

FORD					
MODELO	AÑO	CIL.	MOTOR	SISTEMA	No. PARTE
AEROSTAR	90-91	6	4.0	MPFI	18010
COURIER	01-12	4	1.6		18203
ESCAPE	05-08	4	2.3		18209
ESCAPE	09-15	4	2.5		18209
ESCAPE	05-08	6	3.0		18226
ESCAPE	09-12	6	3.0		18236
EXPLORER	91-91	6	4.0		18010
F-150	95-95	6	4.9		18010
F-250	92-95	8	5.0		18010
F-250	92-97	8	5.8		18010
F-350	92-97	8	5.8		18010
FIESTA	98-01	4	1.3		18203
FIESTA	14-17	4	1.6		18240
FOCUS	05-11	4	2.0		18209
FOCUS ST	13-15	4	2.0		18240
FUSION	06-09	4	2.3		18209
FUSION	10-15	4	2.5		18209
FUSION	06-12	6	3.0		18236
GHIA	91-91	4	2.3		18010
IKON	01-03	4	1.6		18203
KA	01-08	4	1.6		18203
MICROBUS	92-95	8	5.0		18010
RANGER	01-11	4	2.3		18209
TAURUS	88-90	6	3.8		18010
THUNDERBIRD	89-90	6	3.8		18010
THUNDERBIRD SC	89-92	6	3.8		18010

FORD		LINCOLN			
MODELO	AÑO	CIL.	MOTOR	SISTEMA	No. PARTE
ZEPHYR	06	6	3.0	MPFI	18236

FORD		MERCURY			
MODELO	AÑO	CIL.	MOTOR	SISTEMA	No. PARTE
COUGAR XR7	90-90	6	3.8	MPFI	18010
MARINER	05-08	6	3.0		18226
MARINER	09-11	6	3.0		18236
MILAN	07-08	6	3.0		18236
TOPAZ	89-94	4	2.3		18010

GENERAL MOTORS		BUICK			
MODELO	AÑO	CIL.	MOTOR	SISTEMA	No. PARTE
CENTURY	87-89	6	2.8	MPFI	18000
CENTURY	91-95	6	3.1		18000
ENCLAVE	12-15	6	3.6		18220
ENCORE TURBO	14-16	4	1.4		18220
LACROSSE	10-16	6	3.6		18220

GENERAL MOTORS		CADILLAC			
MODELO	AÑO	CIL.	MOTOR	SISTEMA	No. PARTE
CTS	12-14	8	6.2	MPFI	18220
DEVILLE	00-04	8	4.6		18029
ESCALADE	02-06	8	6.0		18029
ESCALADE	03-05	8	5.3		18029
ESCALADE	07-08	8	6.2		18029
ESCALADE ESV	03-06	8	6.0		18029
ESCALADE ESV	07-08	8	6.2		18029
ESCALADE ESV	09-14	8	6.2		18220
ESCALADE EXT	03-06	8	6.0		18029
ESCALADE EXT	07-08	8	6.2		18029
ESCALADE EXT	09-13	8	6.2		18220
SRX	04-06	8	4.6		18029
SRX	10-11	6	3.0		18220
SRX	12-16	6	3.6		18220
STS	05-10	8	4.6		18029
XLR	04-06	8	4.6	18029	

GENERAL MOTORS		CHEVROLET				
MODELO	AÑO	CIL.	MOTOR	SISTEMA	No. PARTE	
ASTRA	01-03	4	2.2	MPFI	18097	
ASTRA	04-06	4	2.0		18241	
ASTRA	04-06	4	2.4		18242	
AVALANCHE	02-08	8	5.3		18029	
AVALANCHE	09-13	8	5.3		18220	
AVEO	08-17	4	1.6		18213	
BEAT	18-18	4	1.2		18220	
BLAZER	95-95	6	4.3		TBI	18000
BLAZER	96-01	6	4.3		MPFI	18029
BLAZER NEVADA	91-94	6	3.1		TBI	18000
C2500	94-95	8	5.7	MPFI	18000	
C2500	96-98	8	5.0		18029	
C2500	96-98	8	5.7		18029	
C3500	94-95	8	5.7		TBI	18000
C3500	96-00	8	5.7		18029	
CAMARO	95-95	6	3.4		18000	
CAMARO	95-97	8	5.7		18000	
CAMARO	98-02	8	5.7		18097	
CAMARO	13-14	6	3.6		18220	
CAMARO	10-14	8	6.2		18220	
CAPTIVA SPORT	08-15	4	2.4	18220		
CAPTIVA SPORT	11-15	6	3.0	18220		
CAPTIVA SPORT	08-10	6	3.6	18220		
CAVALIER	95-98	4	2.2	18000		
CAVALIER	90-94	6	2.8	18000		
CAVALIER	99-04	4	2.2	18097		
CAVALIER Z24	91-94	6	3.1	18000		

CONTINÚA»

GENERAL MOTORS		CHEVROLET				
MODELO	AÑO	CIL.	MOTOR	SISTEMA	No. PARTE	
CAVALIER Z24	96-97	4	2.4	MPFI	18096	
CELEBRITY	87-89	6	2.8		18000	
CHEVY	96-03	4	1.6		18000	
CHEVY	94-95	4	1.4	TBI	18000	
CHEVY	96-03	4	1.4		18000	
CHEVY	96-03	4	1.6	MPFI	18000	
CHEVY	09-12	4	1.6		18098	
CHEVY C2	04-08	4	1.6	TBI	18000	
CHEVY MONZA	96-03	4	1.6		18000	
CHEVY MONZA	96-03	4	1.6	MPFI	18000	
CHEVY PICK UP	99-03	4	1.6		18000	
CHEVY WAGON	00-03	4	1.6		18000	
CHEYENNE	10-14	8	5.3		18220	
COLORADO	04-06	5	3.5		18097	
COLORADO	07-07	5	3.7		18097	
COLORADO	07-07	4	2.9		18097	
COLORADO	08-12	4	2.9		18220	
COLORADO	08-12	5	3.7		18220	
CORSA	02-04	4	1.4		18097	
CORSA	03-05	4	1.8		18227	
CORSA	06-08	4	1.8		18229	
CORVETTE	94-97	8	5.7		18000	
CORVETTE	97-04	8	5.7		18097	
CORVETTE	05-07	8	6.0		18097	
CORVETTE	08-08	8	6.2		18220	
CORVETTE	12-13	8	6.2		18220	
CORVETTE ZR-1	91-95	8	5.7	18001		
CORVETTE ZR1 / SC	12-13	8	6.2	18220		
CRUZE TURBO	15-15	4	1.4	18220		
EQUINOX	05-08	6	3.4	18097		
EXPRESS 1500	96-06	6	4.3	18098		
EXPRESS 1500	03-08	8	5.3	18098		
EXPRESS 1500	09-13	8	5.3	18220		
EXPRESS 2500	96-02	8	5.7	18098		
EXPRESS 2500	09-13	8	6.0	18220		
EXPRESS 3500	03-08	8	6.0	18098		
EXPRESS 3500	96-02	8	5.7	18098		
EXPRESS 3500	09-13	8	6.0	18220		
HHR	06-07	4	2.4	18097		
HHR	08-09	4	2.4	18220		
IMPALA	00-03	6	3.4	18000		
LUMINA	96-96	6	3.4	18098		
MALIBU	97-02	6	3.1	18000		
MALIBU	97-99	4	2.4	18096		
MALIBU	04-06	4	2.2	18097		
MALIBU	04-07	6	3.5	18097		
MALIBU	07-07	4	2.2	18220		
MALIBU	08-12	4	2.4	18220		
MALIBU	09-12	6	3.6	18220		
MATIZ	11-15	4	1.0	18214		
MICROBUS	92-99	8	5.7	TBI	18000	
OPTRA	06-10	4	2.0	MPFI	18234	
P30	92-96	8	5.7	TBI	18000	
P30	96-99	8	5.7		18098	
S10	95-97	4	2.2	MPFI	18000	
S10	98-03	4	2.2		18097	
S10 MAXICAB	91-93	6	3.1	TBI	18000	
SILVERADO 1500	99-06	6	4.3	MPFI	18098	
SILVERADO 1500	07-11	6	4.3		18220	
SILVERADO 2500	99-08	8	5.3		18098	
SILVERADO 3500	01-07	8	6.0		18098	
SONIC	12-17	4	1.6		18220	
SONIC TURBO	14-16	4	1.4		18220	
SONORA	00-02	8	5.7		18098	
SPARK CLASSIC	11-17	4	1.2		18220	
SUBURBAN	92-99	8	5.7		TBI	18000

GENERAL MOTORS		CHEVROLET				
MODELO	AÑO	CIL.	MOTOR	SISTEMA	No. PARTE	
SUBURBAN	98-99	8	5.7	MPFI	18098	
SUBURBAN	09-14	8	5.3		18220	
SUBURBAN 1500	00-08	8	5.3		18098	
SUBURBAN 2500	00-08	8	6.0		18098	
SUBURBAN 2500	09-13	8	6.0		18220	
TAHOE	07-08	8	5.3		18098	
TAHOE	09-13	8	5.3		18220	
TORNADO	11-14	4	1.8		18220	
TORNADO	04-05	4	1.8		18227	
TORNADO	06-10	4	1.8		18229	
TRAIL BLAZER	02-07	6	4.2		18097	
TRAIL BLAZER	03-06	8	5.3	18098		
TRAIL BLAZER EXT	02-06	6	4.2	18097		
TRAIL BLAZER EXT	03-06	8	5.3	18098		
TRAVERSE	12-15	6	3.6	18220		
TRAX	13-16	4	1.8	18220		
TRAX TURBO	14-15	4	1.4	18220		
UPLANDER	07-07	6	3.9	18097		
UPLANDER	05-06	6	3.5	18097		
UPLANDER	08-08	6	3.9	18220		
VECTRA	03-05	4	2.2	18097		
VENTURE	97-04	6	3.4	18000		
ZAFIRA	02-05	4	2.2	18097		

GENERAL MOTORS		GMC				
MODELO	AÑO	CIL.	MOTOR	SISTEMA	No. PARTE	
ACADIA	07-08	6	3.6	MPFI	18220	
ACADIA	12-15	6	3.6		18220	
CANYON	07-07	5	3.7		18097	
CANYON	08-12	5	3.7		18220	
SIERRA 1500	09-13	8	5.3		18220	
SIERRA 1500	09-13	8	6.2		18220	
TERRAIN	11-12	6	3.0		18220	
TERRAIN	13-16	6	3.6		18220	
YUKON	07-08	8	6.2		18029	
YUKON	09-09	8	5.3		18220	
YUKON	09-13	8	6.2	18220		

GENERAL MOTORS		HUMMER				
MODELO	AÑO	CIL.	MOTOR	SISTEMA	No. PARTE	
H2	04-07	8	6.0	MPFI	18029	
H2	09-09	8	6.2		18220	
H3	06-06	5	3.5		18097	
H3	08-10	8	5.3		18220	
H3T	09-10	5	3.7		18220	
H3T	09-10	8	5.3		18220	

GENERAL MOTORS		OLDSMOBILE				
MODELO	AÑO	CIL.	MOTOR	SISTEMA	No. PARTE	
88	92-94	6	3.8	MPFI	18000	
CUTLASS	87-88	6	2.8		18000	
CUTLASS	89-95	6	3.1		18000	
SILHOUETTE	91-94	6	3.1		18000	

GENERAL MOTORS		PONTIAC				
MODELO	AÑO	CIL.	MOTOR	SISTEMA	No. PARTE	
AZTEK	04-05	6	3.4	MPFI	18029	
AZTEK	01-03	6	3.4		18095	
BONNEVILLE	94-99	6	3.8		18003	
G3	07-08	4	1.6		18213	
G3	09-09	4	1.6		18220	
G5	07-09	4	2.2		18220	
G5 GT	07-07	4	2.4		18097	
G5 GT	08-08	4	2.4		18220	
G6	05-06	6	3.5		18097	
G6	08-09	6	3.5		18220	



GENERAL MOTORS		PONTIAC			
MODELO	AÑO	CIL.	MOTOR	SISTEMA	No. PARTE
G6	08-09	6	3.6	MPFI	18220
GRAND AM	99-04	6	3.4		18095
GRAND PRIX	97-01	6	3.1		18000
GRAND PRIX SC	97-01	6	3.8		18029
MATIZ	04-10	4	1.0		18214
MONTANA	07-07	6	3.9		18097
SOLSTICE	06-06	4	2.4		18097
SOLSTICE	07-09	4	2.4		18220
SUNFIRE	95-97	4	2.2		18095
SUNFIRE	97-02	4	2.4		18096
SUNFIRE	98-05	4	2.2		18097
TORRENT	06-09	6	3.4		18097

HONDA					
MODELO	AÑO	CIL.	MOTOR	SISTEMA	No. PARTE
ACCORD	03-04	4	2.4	MPFI	18031
ACCORD	03-04	6	3.0		18031
ACCORD	98-99	6	3.0		18210
ACCORD	08-17	4	2.4		18235
ACCORD	08-17	6	3.5		18235
ACCORD	00-02	6	3.0		18246
ACCORD EX	98-02	4	2.3		18210
CIVIC	01-05	4	1.7		18031
CIVIC	97-00	4	1.6		18210
CIVIC	06-15	4	1.8		18235
CIVIC HIBRIDO	12-12	4	1.5		18235
CIVIC SI	12-15	4	2.4		18235
CR-V	02-04	4	2.4		18031
CR-V	07-17	4	2.4		18235
CR-V	17-17	4	1.5		18235
CR-Z HIBRIDO	13-15	4	1.5		18235
FIT	09-17	4	1.5		18235
ODYSSEY	01-04	6	3.5		18031
ODYSSEY	07-15	6	3.5		18235
ODYSSEY	00-00	6	3.5		18246
PILOT	03-04	6	3.5	18031	
PILOT	09-15	6	3.5	18235	
RIDGELINE	09-14	6	3.5	18235	

LAND ROVER					
MODELO	AÑO	CIL.	MOTOR	SISTEMA	No. PARTE
FREELANDER	02-05	6	2.5	MPFI	18223

MAZDA					
MODELO	AÑO	CIL.	MOTOR	SISTEMA	No. PARTE
3	06-13	4	2.0	MPFI	18209
3	06-09	4	2.3		18209
3	10-13	4	2.5		18209
5	06-10	4	2.3		18209
5	12-15	4	2.5		18209
6	06-08	4	2.3		18209
6	09-13	4	2.5		18209
3 SPEED TURBO	08-13	4	2.3		18237
CX-7	11-12	4	2.5		18209
CX-7	10-10	4	2.5		18237
CX-7 TURBO	07-12	4	2.3		18237
MX-5 MIATA	08-14	4	2.0		18209
MX-5 MIATA	06-07	4	2.0		18237

MINI					
MODELO	AÑO	CIL.	MOTOR	SISTEMA	No. PARTE
COOPER	02-08	4	1.6	MPFI	18223
COOPER S	02-08	4	1.6		18224

MITSUBISHI					
MODELO	AÑO	CIL.	MOTOR	SISTEMA	No. PARTE
ECLIPSE	06-10	6	3.8	MPFI	18232
ECLIPSE	04-05	6	3.0		18232
ENDEAVOR	05-10	6	3.8		18232
GALANT	04-09	4	2.4		18232
GALANT	04-09	6	3.8		18232
GRANDIS	07-09	4	2.4		18232
LANCER	04-08	4	2.0		18232
LANCER GTS	09-09	4	2.4		18232
LANCER RALLIART	05-06	4	2.4		18232
MONTERO	03-06	6	3.8		18232
MONTERO SPORT	04-04	6	3.5		18232
OUTLANDER	04-08	4	2.4		18232
OUTLANDER	07-08	6	3.0		18232

NISSAN					
MODELO	AÑO	CIL.	MOTOR	SISTEMA	No. PARTE
PLATINA	02-10	4	1.6	MPFI	18208

PEUGEOT					
MODELO	AÑO	CIL.	MOTOR	SISTEMA	No. PARTE
206	01-05	4	1.6	MPFI	18204
206	00-05	4	1.4		18204
306	01-02	4	1.8		18204
307	03-07	4	2.0		18212
406	01-05	6	3.0		18212
607	03-06	6	3.0		18212

RENAULT					
MODELO	AÑO	CIL.	MOTOR	SISTEMA	No. PARTE
CLIO	02-10	4	1.6	MPFI	18208
CLIO SPORT	02-06	4	2.0		18208
DUSTER	13-16	4	2.0		18208
FLUENCE	11-14	4	2.0		18208
MEGANE	02-03	4	2.0		18208
MEGANE II	04-05	4	2.0		18208
SANDERO	10-15	4	1.6		18208
SCENIC	02-05	4	2.0		18208

SAAB					
MODELO	AÑO	CIL.	MOTOR	SISTEMA	No. PARTE
9-5	01-05	4	2.3	MPFI	18054
9-5	01-03	6	3.0		18054

SEAT					
MODELO	AÑO	CIL.	MOTOR	SISTEMA	No. PARTE
ALHAMBRA TURBO	02-07	4	1.8	MPFI	18216
ALTEA TURBO	08-10	4	1.8		18216
CORDOBA	04-09	4	1.6		18218
IBIZA	04-09	4	1.6		18218
IBIZA	09-15	4	2.0		18219
LEON FR	07-10	4	2.0		18216
LEON TURBO	01-06	4	1.8		18206
TOLEDO TURBO	01-06	4	1.8		18216

VOLKSWAGEN					
MODELO	AÑO	CIL.	MOTOR	SISTEMA	No. PARTE
BEETLE	14-16	5	2.5	MPFI	18219
BEETLE	06-10	5	2.5		18239
BEETLE TURBO	99-05	4	1.8		18206
BEETLE TURBO	12-16	4	2.0		18216
BORA	06-08	5	2.5		18239
BORA GLI	06-10	4	2.0		18216
CROSSFOX	07-09	4	1.6		18219
CROSSFOX	11-17	4	1.6		18219
EOS TURBO	10-10	4	2.0		18216
GOL	09-17	4	1.6		18219



**SENSORES DE PRESIÓN ABSOLUTA DEL MÚLTIPLE (MAP)**

VOLKSWAGEN					
MODELO	AÑO	CIL.	MOTOR	SISTEMA	No. PARTE
GOLF A4 GTI	00-04	4	1.8	MPFI	18206
GOLF A5 GTI	07-09	4	2.0		18216
GOLF A5 SPORT WAGEN	10-13	5	2.5		18219
GOLF A6 GTI	10-13	4	2.0		18216
JETTA A4	06-10	4	2.0		18219
JETTA A4 CLASICO	10-15	4	2.0		18219
JETTA A4 TDI	06-06	4	1.9		18225
JETTA A4 TURBO	00-05	4	1.8		18206
JETTA A6	11-16	5	2.5		18219
JETTA A6 GLI	12-16	4	2.0		18216
JETTA A6 TDI	11-12	4	2.0		18225
LUPO	05-09	4	1.6		18218
PASSAT	12-16	5	2.5		18219
PASSAT TURBO	00-03	4	1.8		18206
PASSAT TURBO	03-05	4	1.8		18216

VOLKSWAGEN					
MODELO	AÑO	CIL.	MOTOR	SISTEMA	No. PARTE
PASSAT TURBO	06-10	4	2.0	MPFI	18216
POINTER	98-09	4	1.8		18201
POINTER GTI	00-03	4	2.0		18201
POINTER PICK UP	99-07	4	1.8		18201
POLO	03-07	4	1.6		18218
ROUTAN	11-12	6	3.6		18221
ROUTAN	09-10	6	3.8		18243
SAVEIRO	10-16	4	1.6		18219
SHARAN TURBO	02-04	4	1.8		18206
TIGUAN TURBO	09-16	4	2.0		18216
TOUAREG TDI	11-14	6	3.0		18219
TOUAREG TDI	07-07	10	4.9		18225
TOUAREG TDI / TURBO BOOST	09-14	6	3.0		18225
VAN	03-09	4	1.8		18201
VENTO	14-17	4	1.6		18219

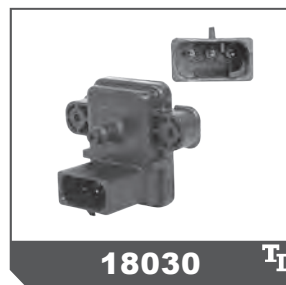
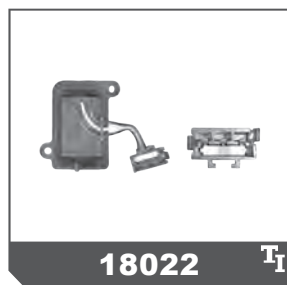

# SENSORES DE PRESIÓN ABSOLUTA DEL MÚLTIPLE (MAP)

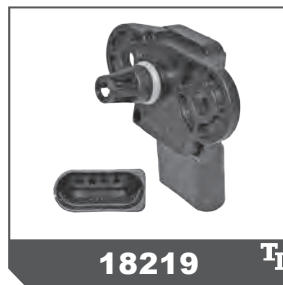
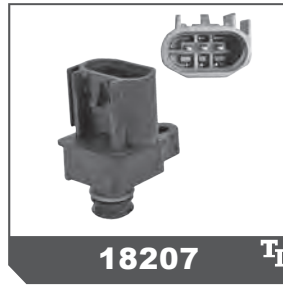
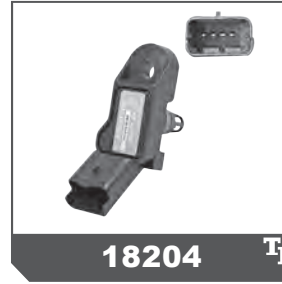

**SENSORES DE PRESIÓN ABSOLUTA DEL MÚLTIPLE (MAP)**



FORD					
MODELO	AÑO	CIL.	MOTOR	SISTEMA	No. PARTE
ECONOLINE E-150	05-06	8	4.6	MPFI	21974
ECONOLINE E-150	07-08	8	4.6		21975
ESCAPE	05-08	4	2.3		21975
ESCAPE	05-08	6	3.0		21975
ESCORT	98-00	4	2.0		21974
EXPEDITION	05-08	8	5.4		21975
EXPLORER	04-05	8	4.6		21974
EXPLORER	04-10	6	4.0		21975
EXPLORER	04-10	8	4.6		21975
EXPLORER SPORT TRAC	07-10	8	4.6		21975
F-150	04-06	8	4.6		21974
F-150	05-08	6	4.2		21975
F-150	07-08	8	4.6		21975
F-250	01-09	8	4.6		21974
F-350	00-09	8	5.4		21974
F-450 SUPER DUTY	05-08	10	6.8		21975
FIVE HUNDRED	05-07	6	3.0		21975
FOCUS	00-04	4	2.0		21974
FOCUS	05-09	4	2.0		21975
FOCUS ST	07-09	5	2.5		21975
FOCUS ZX3	00-04	4	2.0		21974
FREESTAR	04-07	6	4.2	21975	
FUSION	06-09	4	2.3	21975	

FORD					
MODELO	AÑO	CIL.	MOTOR	SISTEMA	No. PARTE
MUSTANG	99-09	8	4.6	MPFI	21974
MUSTANG	05-10	6	4.0		21975
MUSTANG	05-10	8	4.6		21975
MUSTANG SHELBY GT	08-13	8	5.4		21974
MUSTANG SHELBY GT	07-12	8	5.4		21975
THUNDERBIRD	03-03	8	3.9		21974

FORD LINCOLN					
MODELO	AÑO	CIL.	MOTOR	SISTEMA	No. PARTE
AVIATOR	03-05	8	4.6	MPFI	21974
LS	04-05	6	3.0		21974
LS	00-06	6	3.9		21974
MARK LT	06-08	8	5.4		21975
NAVIGATOR	05-08	8	5.4		21975
TOWN CAR	03-04	8	4.6		21974
TOWN CAR	05-07	8	4.6		21975

FORD MERCURY					
MODELO	AÑO	CIL.	MOTOR	SISTEMA	No. PARTE
GRAND MARQUIS	03-04	8	4.6	MPFI	21974
MARINER	05-08	6	3.0		21975
MONTEGO	05-07	6	3.0		21975
SABLE	02-04	6	3.0		21974

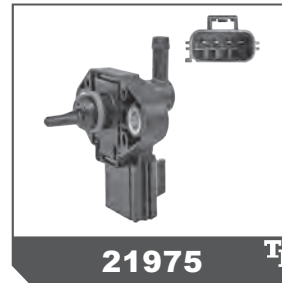
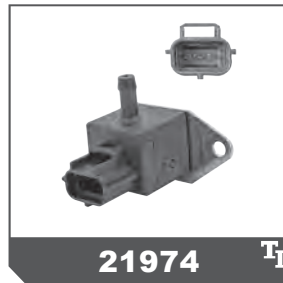

**SU FUNCIÓN:**

Miden la temperatura del aire que entra en el múltiple de admisión.

La resistencia del sensor cambia al subir la temperatura. La computadora recibe este cambio mediante una señal y ajusta la duración del pulso del inyector y la mezcla de combustible.

**SÍNTOMAS DE FALLA:**

La luz "chechar motor" se enciende continuamente, jaloneo en el vehículo, bajo rendimiento de gasolina, incremento de emisiones contaminantes, gasto excesivo de combustible.

**MANTENIMIENTO/SERVICIO:**

Inspeccionar si hay daños o corrosión en las terminales cuando existen códigos que indican problemas en este circuito. Cheque el sensor para ver si hay acumulación de carbón o contaminantes que pueden causar falsas lecturas.

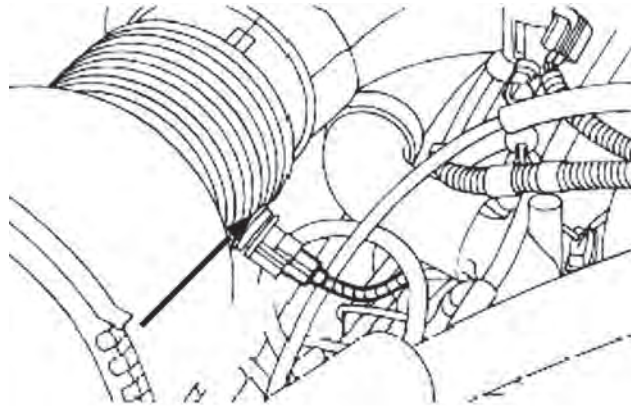

ACURA					
MODELO	AÑO	CIL.	MOTOR	SISTEMA	No. PARTE
MDX	05-06	6	3.5	MPFI	12207
MDX	05-06	6	3.5		12214
RL	05-08	6	3.5		12214
TL	05-08	6	3.2		12214

AUDI					
MODELO	AÑO	CIL.	MOTOR	SISTEMA	No. PARTE
A4 QUATTRO TURBO	98-01	4	1.8	MPFI	12204
A4 QUATTRO VR6	98-01	6	2.8		12204
A4 TURBO	97-01	4	1.8		12204
A4 TURBO	03-06	4	1.8		12204
A4 VR6	97-01	6	2.8		12204
A6	99-01	6	2.8		12204
TT QUATTRO	04-06	6	3.2		12204
TT QUATTRO TURBO	00-06	4	1.8		12204
TT TURBO	00-06	4	1.8		12204

CHRYSLER					
MODELO	AÑO	CIL.	MOTOR	SISTEMA	No. PARTE
200	12-14	4	2.4	MPFI	12205
300C	09-10	8	5.7		12205
300C	05-10	6	3.5		12213
300C	05-08	8	5.7		12213
300C SRT-8	06-08	8	6.1		12213
300M	01-04	6	3.5		12213
ASPEN	07-09	8	5.7		12205
ASPEN	09-09	8	5.7		12213
CIRRUS	96-96	4	2.4		12118
CIRRUS	96-96	6	2.5		12118
CIRRUS	97-00	6	2.5		12196
CIRRUS	97-00	4	2.4		12196
CONCORDE	02-02	6	3.5		12213
CONCORDE ACT	97-97	6	3.5		12118
CONCORDE IAT	93-97	6	3.5		12111
GRAND VOYAGER	96-96	6	3.8		12118
LEBARON K	84-84	4	2.2		12110
LEBARON K / TURBO	86-87	4	2.2		12107
LEBARON TURBO	92-93	4	2.5		12111
NEW YORKER K	84-84	4	2.2		12110
NEW YORKER K TURBO	85-89	4	2.2		12014
NEW YORKER LH	94-96	6	3.5		12111
NEW YORKER TURBO	91-93	4	2.5		12111
NEW YORKER TURBO	89-89	4	2.2		12111
PACIFICA	04-06	6	3.5		12213

CHRYSLER					
MODELO	AÑO	CIL.	MOTOR	SISTEMA	No. PARTE
PACIFICA	07-07	6	3.8	MPFI	12213
PACIFICA	07-08	6	4.0		12213
PHANTOM TURBO	90-94	4	2.5		12111
PT CRUISER	01-10	4	2.4		12213
PT CRUISER TURBO	03-07	4	2.4		12213
TOWN & COUNTRY	93-93	6	3.3		12111
TOWN & COUNTRY	94-95	6	3.8		12111
TOWN & COUNTRY	96-96	6	3.8		12118
TOWN & COUNTRY	97-00	6	3.8		12196
TOWN & COUNTRY	01-07	6	3.8		12213
TOWN & COUNTRY	08-10	6	4.0		12213
VOYAGER	94-94	6	3.3		12111
VOYAGER	96-96	6	3.3		12118
VOYAGER	97-00	6	3.3		12196
VOYAGER	01-08	6	3.3		12213

CHRYSLER DODGE					
MODELO	AÑO	CIL.	MOTOR	SISTEMA	No. PARTE
AVENGER	08-10	4	2.0	MPFI	12213
AVENGER	08-14	4	2.4		12205
AVENGER	08-12	4	2.4		12213
AVENGER	08-10	6	3.5		12205
AVENGER	08-10	6	3.5		12213
CALIBER	07-09	4	1.8		12213
CALIBER	07-09	4	2.0		12213
CALIBER	07-12	4	2.4		12213
CALIBER SRT-4	08-09	4	2.4		12213
CHALLENGER R/T	09-10	8	5.7		12205
CHALLENGER SRT-8	08-10	8	6.1		12213
CHARGER	06-10	6	3.5		12213
CHARGER R/T	06-08	8	5.7		12213
CHARGER R/T	09-10	8	5.7		12205
CHARGER SRT-8	07-10	8	6.1		12213
DAKOTA	05-10	6	3.7		12205
DAKOTA	07-07	8	4.7		12205
DURANGO	01-09	8	4.7		12205
DURANGO	00-00	8	4.7		12196
DURANGO	98-00	8	5.2		12196
DURANGO	04-09	8	5.7		12205
DURANGO	98-03	8	5.9		12196
INTREPID	98-98	6	2.7		12196
INTREPID	99-00	6	3.5	12213	
INTREPID ACT	97-97	6	3.5	12118	
INTREPID IAT	94-97	6	3.5	12111	



<b>CHRYSLER</b>		<b>DODGE</b>				
MODELO	AÑO	CIL.	MOTOR	SISTEMA	No. PARTE	
JOURNEY	09-17	4	2.4	MPFI	12213	
JOURNEY R/T	09-10	6	3.5		12213	
JOURNEY R/T	12-12	6	3.6		12213	
MAGNUM K	84-84	4	2.2		12110	
MAGNUM K TURBO	85-88	4	2.2		12014	
MICROBUS	91-94	8	5.9		TBI	12107
NEON	00-05	4	2.0		MPFI	12213
NEON	95-97	4	2.0			12118
NEON SRT-4	04-05	4	2.4			12213
NITRO	07-11	6	3.7			12213
NITRO R/T	07-09	6	4.0	12213		
RAM 1500	02-13	6	3.7	12205		
RAM 1500	10-10	6	3.7	12213		
RAM 1500	02-02	6	3.9	12205		
RAM 1500	94-96	6	3.9	12118		
RAM 1500	97-01	6	3.9	12196		
RAM 1500 COLECTOR DE AIRE	11-13	6	3.7	12213		
RAM 2500	05-06	8	4.7	12205		
RAM 2500	94-96	8	5.2	12118		
RAM 2500	97-00	8	5.2	MPFI	12196	
RAM 2500	03-08	8	5.7	12205		
RAM 2500	09-10	8	5.7	12213		
RAM 2500	94-96	8	5.9	12118		
RAM 2500	97-02	8	5.9	12196		
RAM 3500	94-96	8	5.9	12118		
RAM 3500	97-02	8	5.9	12196		
RAM 4000	94-96	8	5.9	12118		
RAM 4000	97-00	8	5.9	12196		
RAMCHARGER	88-94	8	5.9	TBI	12107	
RAMCHARGER	91-93	8	5.9	MPFI	12118	
SHADOW	91-94	4	2.5		12111	
SHADOW GTS	89-90	4	2.2		12111	
SPIRIT	94-94	4	2.5		12111	
STRATUS	01-06	4	2.0		12213	
STRATUS	95-96	4	2.0		12118	
STRATUS	97-00	4	2.0		12196	
STRATUS	01-06	4	2.4		12213	
STRATUS	95-96	4	2.4		12118	
STRATUS	97-00	4	2.4		12196	
VIPER	04-05	10	8.3	12213		

<b>CHRYSLER</b>		<b>JEEP</b>			
MODELO	AÑO	CIL.	MOTOR	SISTEMA	No. PARTE
CHEROKEE SPORT	94-94	6	4.0	MPFI	12118
CHEROKEE SPORT	98-01	6	4.0		12196
COMMANDER	06-07	8	4.7		12205
COMPASS	07-17	4	2.4		12213
GRAND CHEROKEE	94-96	6	4.0		12118
GRAND CHEROKEE	94-96	8	5.2		12118
GRAND CHEROKEE	99-03	8	4.7		12196
GRAND CHEROKEE	97-04	6	4.0		12196
GRAND CHEROKEE	97-98	8	5.2		12196
GRAND CHEROKEE	98-98	8	5.9		12196
GRAND CHEROKEE	05-10	6	3.7	12205	
GRAND CHEROKEE	01-04	8	4.7	12205	
GRAND CHEROKEE	10-10	8	5.7	12213	
GRAND CHEROKEE SRT-8	07-10	8	6.1	12213	
LIBERTY	02-03	6	3.7	12205	
LIBERTY	04-12	6	3.7	12213	
PATRIOT	07-17	4	2.4	12213	
TJ	97-02	4	2.5	12196	
TJ	97-04	6	4.0	12196	
WRANGLER	93-95	4	2.5	12118	
WRANGLER	98-05	6	4.0	12196	
WRANGLER	97-02	4	2.5	12196	

<b>CHRYSLER</b>		<b>JEEP</b>			
MODELO	AÑO	CIL.	MOTOR	SISTEMA	No. PARTE
WRANGLER	05-06	6	4.0	MPFI	12205
WRANGLER	05-06	4	2.4		12213
WRANGLER	07-07	6	3.8		12213
WRANGLER ACT	03-04	4	2.4		12205
WRANGLER IAT	03-03	4	2.4		12196

<b>FIAT</b>					
MODELO	AÑO	CIL.	MOTOR	SISTEMA	No. PARTE
PALIO	04-05	4	1.6	MPFI	12203
PALIO ADVENTURE	04-05	4	1.6		12203

<b>FORD</b>					
MODELO	AÑO	CIL.	MOTOR	SISTEMA	No. PARTE
AEROSTAR	91-95	6	3.0	MPFI	12100
AEROSTAR	91-95	6	4.0		12100
CONTOUR	95-95	4	2.0		12100
CONTOUR	96-97	4	2.0		12124
CONTOUR	95-95	6	2.5		12125
CONTOUR	98-99	4	2.0		12126
CONTOUR	96-00	6	2.5		12127
ECONOLINE E-150	95-95	6	4.9		12125
ECONOLINE E-150	97-01	6	4.2		12126
ECONOLINE E-250	99-04	8	5.4		12126
ECONOLINE E-250	97-01	6	4.2	12126	
ECONOLINE E-350	97-04	8	5.4	12126	
ESCORT	94-95	4	1.9	12117	
ESCORT	96-96	4	1.9	12124	
ESCORT	97-01	4	2.0	12126	
EXCURSION	01-03	10	6.8	12124	
EXCURSION	04-04	10	6.8	12126	
EXPEDITION	97-02	8	5.4	12126	
EXPEDITION	97-02	8	4.6	12126	
EXPLORER	91-96	6	4.0	12100	
EXPLORER	97-01	6	4.0	12126	
EXPLORER	96-01	8	5.0	12126	
EXPLORER IAT	95-95	6	4.0	12125	
F-150	92-94	6	3.8	12100	
F-150	97-08	6	4.2	12126	
F-150	97-08	8	4.6	MPFI	12126
F-150	96-96	6	4.9	12127	
F-250	92-95	8	5.0	12100	
F-250	88-94	8	5.8	12100	
F-250	97-99	8	4.6	12126	
F-250	96-96	8	5.0	12127	
F-350	92-95	8	5.0	12100	
F-350	92-94	8	5.8	12100	
F-350 SUPER DUTY ACT	99-08	8	5.4	12126	
F-350 SUPER DUTY IAT	99-99	8	5.4	12124	
F-550 SUPER DUTY	99-04	10	6.8	12126	
GHIA	91-91	4	2.3	12100	
GHIA	92-94	6	3.0	12117	
LOBO	01-03	8	5.4	12126	
MICROBUS	92-95	8	5.0	12100	
MUSTANG	94-95	8	5.0	12117	
MUSTANG	94-94	8	5.0	12119	
MUSTANG	96-04	8	4.6	12126	
MUSTANG SHELBY GT	08-09	8	5.4	12124	
RANGER	95-06	6	3.0	12126	
RANGER	04-06	4	2.3	12126	
RANGER	95-97	4	2.3	12126	
RANGER	01-02	4	2.3	12126	
RANGER	03-03	4	2.3	12127	
TAURUS	88-91	6	3.8	12100	
THUNDERBIRD	89-95	6	3.8	12100	



**SENSORES DE TEMPERATURA DE CARGA DE AIRE (ACT, IAT, MAT)**

<b>FORD</b>					
MODELO	AÑO	CIL.	MOTOR	SISTEMA	No. PARTE
THUNDERBIRD	91-93	8	5.0	MPFI	12100
THUNDERBIRD	95-95	8	4.6		12117
THUNDERBIRD	96-96	8	4.6		12126
THUNDERBIRD	03-03	8	3.9		12126
THUNDERBIRD	96-96	8	4.6		12127
THUNDERBIRD	96-96	6	3.8		12127
WINDSTAR ACT	95-03	6	3.8		12100
WINDSTAR IAT	95-03	6	3.8		12127

<b>FORD LINCOLN</b>					
MODELO	AÑO	CIL.	MOTOR	SISTEMA	No. PARTE
LS	00-03	8	3.9	MPFI	12126
MARK VIII	96-96	8	4.6		12124
NAVIGATOR	98-06	8	5.4		12126
TOWN CAR	95-05	8	4.6		12127

<b>FORD MERCURY</b>					
MODELO	AÑO	CIL.	MOTOR	SISTEMA	No. PARTE
COUGAR XR7	90-95	6	3.8	MPFI	12100
GRAND MARQUIS	92-94	8	4.6		12117
GRAND MARQUIS	95-03	8	4.6		12127
MYSTIQUE	95-95	4	2.0		12100
MYSTIQUE	96-97	4	2.0		12124
MYSTIQUE	95-95	6	2.5		12125
MYSTIQUE	98-00	4	2.0		12126
MYSTIQUE	96-00	6	2.5		12127
SABLE	94-95	6	3.8		12100
SABLE	96-99	6	3.0		12127
TOPAZ	89-94	4	2.3		12100

<b>GENERAL MOTORS BUICK</b>					
MODELO	AÑO	CIL.	MOTOR	SISTEMA	No. PARTE
CENTURY	87-89	6	2.8	MPFI	12101
CENTURY	91-95	6	3.1		12101
REGAL	95-96	6	3.8		12130

<b>GENERAL MOTORS CHEVROLET</b>					
MODELO	AÑO	CIL.	MOTOR	SISTEMA	No. PARTE
ASTRA	01-02	4	2.2	MPFI	12130
AVEO	08-17	4	1.6		12210
BEAT	18-18	4	1.2		12216
BLAZER	95-01	6	4.3		12130
C2500	96-98	8	5.0		12130
C2500	96-00	8	5.7		12130
C3500	96-00	8	5.7		12130
CAMARO	95-02	8	5.7		12130
CAMARO	95-95	6	3.4		12130
CAPTIVA SPORT	08-15	4	2.4		12216
CAVALIER	90-94	6	2.8		12101
CAVALIER	95-04	4	2.2		12130
CAVALIER Z24	91-94	6	3.1		12101
CAVALIER Z24	96-97	4	2.4		12130
CELEBRITY	87-88	6	2.8		12101
CHEVY	96-03	4	1.6		12202
CHEVY	09-12	4	1.6		12202
CHEVY C2	04-08	4	1.6		12202
CHEVY MONZA	96-03	4	1.6		12202
CHEVY MONZA	09-12	4	1.6		12202
CHEVY PICK UP	99-03	4	1.6		12202
CHEVY WAGON	00-03	4	1.6		12202
CORVETTE	91-95	8	5.7		12101
CORVETTE	97-01	8	5.7		12130
EXPRESS 1500	96-02	6	4.3		12130
EXPRESS 2500	96-02	8	5.7		12130
EXPRESS 3500	96-02	8	5.7		12130

<b>GENERAL MOTORS CHEVROLET</b>					
MODELO	AÑO	CIL.	MOTOR	SISTEMA	No. PARTE
IMPALA	00-03	6	3.4	MPFI	12130
LUMINA	96-96	6	3.4		12130
LUV	00-05	4	2.2		12130
MALIBU	97-02	4	2.4		12130
MALIBU	97-03	6	3.1		12130
MATIZ	11-15	4	1.0		12209
OPTRA	06-10	4	2.0		12210
P30	96-99	8	5.7		12130
S10	96-01	4	2.2		12130
SPARK CLASSIC	11-17	4	1.2		12216
SUBURBAN	92-99	8	5.7		12130
TRAIL BLAZER	02-05	6	4.2		12130
TRAIL BLAZER	02-05	8	5.3		12130
TRAIL BLAZER EXT	02-05	6	4.2		12130
TRAIL BLAZER EXT	03-05	8	5.3		12130
VECTRA	03-05	4	2.2	12130	
VENTURE	98-04	6	3.4	12130	

<b>GENERAL MOTORS OLDSMOBILE</b>					
MODELO	AÑO	CIL.	MOTOR	SISTEMA	No. PARTE
88	92-94	6	3.8	MPFI	12116
88	95-95	6	3.8		12130
CUTLASS	89-94	6	3.1		12101
CUTLASS	87-88	6	2.8		12101
CUTLASS	95-96	6	3.1		12130
SILHOUETTE	94-95	6	3.8		12116

<b>GENERAL MOTORS PONTIAC</b>					
MODELO	AÑO	CIL.	MOTOR	SISTEMA	No. PARTE
AZTEK	01-05	6	3.4	MPFI	12130
BONNEVILLE	94-99	6	3.8		12130
G3	07-09	4	1.6		12210
GRAND AM	99-04	6	3.4		12130
GRAND PRIX SC	97-01	6	3.8		12130
MATIZ	04-10	4	1.0		12209
MONTANA	05-05	6	3.5		12130
SUNFIRE	97-02	4	2.4		12130
SUNFIRE	97-05	4	2.2		12130

<b>HONDA</b>					
MODELO	AÑO	CIL.	MOTOR	SISTEMA	No. PARTE
ACCORD	98-02	4	2.3	MPFI	12206
ACCORD	98-02	6	3.0		12206
ACCORD	96-97	4	2.2		12206
ACCORD	03-04	4	2.4		12207
ACCORD	03-07	6	3.0		12214
ACCORD AL FILTRO DE AIRE	03-03	6	3.0		12207
ACCORD AL MULTIPLE DE ADMISION	03-03	4	2.4		12214
CIVIC	01-05	4	1.7		12207
CR-V	02-06	4	2.4		12207
FIT	06-08	4	1.5		12207
ODYSSEY	00-04	6	3.5		12206
ODYSSEY	05-10	6	3.5		12214
PILOT	03-05	6	3.5		12206
PILOT	06-08	6	3.5		12214
RIDGELINE	07-08	6	3.5		12214

<b>NISSAN INFINITI</b>					
MODELO	AÑO	CIL.	MOTOR	SISTEMA	No. PARTE
I30	98-99	6	3.0	MPFI	12215
Q45	96-96	8	4.5		12215
Q45	01-01	8	4.1		12215

CONTINÚA»

<b>NISSAN</b>					
MODELO	AÑO	CIL.	MOTOR	SISTEMA	No. PARTE
300ZX	91-96	6	3.0	MPFI	12215
ALTIMA	97-01	4	2.4		12211
ALTIMA	96-97	4	2.4		12215
D21	97-08	4	2.4		12211
FRONTIER	01-04	6	3.3		12211
FRONTIER	01-04	4	2.4		12211
MAXIMA	95-01	6	3.0		12215
NP300	09-15	4	2.4		12211
PATHFINDER	98-00	6	3.3		12215
PATHFINDER	01-04	6	3.5		12215
PATHFINDER ARMADA	04-04	8	5.6		12215
PLATINA	02-10	4	1.6		12201
QUEST	97-98	6	3.0		12211
QUEST	99-02	6	3.3		12211
SENTRA	01-06	4	1.8		12211
SENTRA	00-01	4	2.0		12211
SENTRA	00-00	4	1.6		12211
SENTRA	97-99	4	1.6		12215
SENTRA	97-99	4	2.0		12215
SENTRA SE-R	02-05	4	2.5		12211
TSURU III	09-16	4	1.6		12211
XTERRA	00-04	6	3.3		12211
XTERRA	00-04	4	2.4		12211
XTERRA	05-05	6	4.0		12211

<b>PEUGEOT</b>					
MODELO	AÑO	CIL.	MOTOR	SISTEMA	No. PARTE
307	03-07	4	2.0	MPFI	12208
406	00-05	4	2.0		12208
407	06-09	4	2.2		12208
407	06-08	6	3.0		12208
607	03-06	6	3.0		12208

<b>RENAULT</b>					
MODELO	AÑO	CIL.	MOTOR	SISTEMA	No. PARTE
CLIO	02-10	4	1.6	MPFI	12201
CLIO SPORT	02-06	4	2.0		12201
DUSTER	13-16	4	2.0		12201
FLUENCE	11-14	4	2.0		12201
MEGANE	01-03	4	2.0		12201
MEGANE II	04-10	4	2.0		12201
MEGANE II	08-10	4	1.6		12201
SANDERO	10-15	4	1.6		12201
SCENIC	01-05	4	2.0		12201

<b>SEAT</b>					
MODELO	AÑO	CIL.	MOTOR	SISTEMA	No. PARTE
LEON TURBO	01-04	4	1.8	MPFI	12204
TOLEDO TURBO	01-05	4	1.8		12204

<b>VOLKSWAGEN</b>					
MODELO	AÑO	CIL.	MOTOR	SISTEMA	No. PARTE
BEETLE TURBO	99-03	4	1.8	MPFI	12204
COMBI	93-94	4	1.8		12199
DERBY	95-00	4	1.8		12199
DERBY	01-03	4	2.0		12199
GOLF A3	93-94	4	1.8		12199
GOLF A4 GTI	00-05	4	1.8		12204
JETTA A3	93-94	4	1.8		12199
JETTA A4 TURBO	99-05	4	1.8		12204
PASSAT TURBO	98-03	4	1.8		12204
PASSAT VR6	98-05	6	2.8		12204
SEDAN	93-04	4	1.6		12199
SHARAN TURBO	02-04	4	1.8		12204



**SENSORES DE TEMPERATURA DE CARGA DE AIRE (ACT, IAT, MAT)**



<b>FORD</b>					
MODELO	AÑO	CIL.	MOTOR	SISTEMA	No. PARTE
ECONOLINE E-150	04-08	8	5.4	MPFI	12501
ECONOLINE E-150	99-03	6	4.2		12502
ECONOLINE E-250	99-04	8	5.4		12501
ECONOLINE E-250	99-03	6	4.2		12502
ECONOLINE E-350	97-03	8	5.4		12501
EXCURSION	01-05	10	6.8		12501
EXPEDITION	97-04	8	4.6		12501
EXPEDITION	97-04	8	5.4		12501
EXPLORER	02-05	8	4.6		12501
F-150	97-10	8	4.6		12501
F-150	05-08	6	4.2		12502
F-250	97-99	8	4.6		12501
F-350 SUPER DUTY	99-04	8	5.4		12501
F-450 SUPER DUTY	01-04	10	6.8		12501
F-550 SUPER DUTY	01-04	10	6.8	12501	
FREESTAR	04-07	6	4.2	12502	
MUSTANG SHELBY GT	08-12	8	5.4	12501	

<b>FORD</b>		<b>LINCOLN</b>			
MODELO	AÑO	CIL.	MOTOR	SISTEMA	No. PARTE
AVIATOR	03-05	8	4.6	MPFI	12501
NAVIGATOR	00-04	8	5.4		12501
TOWN CAR	98-07	8	4.6		12501

<b>FORD</b>		<b>MERCURY</b>			
MODELO	AÑO	CIL.	MOTOR	SISTEMA	No. PARTE
GRAND MARQUIS	98-04	8	4.6	MPFI	12501

<b>GENERAL MOTORS</b>		<b>CHEVROLET</b>			
MODELO	AÑO	CIL.	MOTOR	SISTEMA	No. PARTE
ASTRA	04-05	4	2.4	MPFI	12200

<b>VOLKSWAGEN</b>					
MODELO	AÑO	CIL.	MOTOR	SISTEMA	No. PARTE
SEDAN	93-04	4	1.6	MPFI	12200



**SU FUNCIÓN:**

Este es un sensor muy importante para los motores controlados por computadora. Mide la temperatura del refrigerante y manda la señal a la computadora para ajustar la mezcla de aire-combustible.

**SÍNTOMAS DE FALLA:**

Economía y rendimiento muy bajos y dificultad para arrancar. Se enciende la luz "chechar motor" cuando este sensor falla.

**MANTENIMIENTO/SERVICIO:**

Inspeccionar cada 20,000-25,000 kms. Checar el sensor mediante los valores específicos de resistencia. El líquido refrigerante viejo puede ocasionar mal funcionamiento de este sensor.

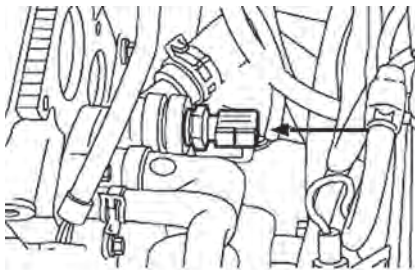

ACURA					
MODELO	AÑO	CIL.	MOTOR	SISTEMA	No. PARTE
ILX	13-15	4	2.0	MPFI	12323
MDX	05-06	6	3.5		12317
MDX	14-16	6	3.5		12323
MDX	07-13	6	3.7		12323
RDX	13-17	6	3.5		12323
RDX TURBO	07-12	4	2.3		12323
RL	05-08	6	3.5		12317
RL	09-10	6	3.7		12323
TL	05-06	6	3.2		12317
TL	07-08	6	3.2		12323
TL	09-13	6	3.5		12323
TL	09-13	6	3.7		12323
TSX	09-13	4	2.4		12323
TSX	10-13	6	3.5		12323
ZDX	10-11	6	3.7		12323

AUDI					
MODELO	AÑO	CIL.	MOTOR	SISTEMA	No. PARTE
A3	06-08	6	3.2	MPFI	12312
A3 QUATTRO	06-06	6	3.2		12312
A3 QUATTRO TURBO	09-11	4	2.0		12312
A3 TURBO	98-98	4	1.8		12304
A3 TURBO	08-15	4	1.4		12312
A3 TURBO	05-13	4	2.0		12312
A4	02-05	6	3.0		12312
A4	05-08	6	3.2		12312
A4	05-08	6	3.2		12302
A4	02-05	6	3.0		12302
A4 QUATTRO	02-05	6	3.0		12312
A4 QUATTRO	13-13	6	3.0		12312
A4 QUATTRO	05-08	6	3.2		12302
A4 QUATTRO	02-05	6	3.0		12302
A4 QUATTRO TURBO	02-05	4	1.8		12312
A4 QUATTRO TURBO	05-13	4	2.0		12312
A4 QUATTRO TURBO	98-05	4	1.8		12302

AUDI					
MODELO	AÑO	CIL.	MOTOR	SISTEMA	No. PARTE
A4 QUATTRO TURBO	05-08	4	2.0	MPFI	12302
A4 QUATTRO VR6	00-00	6	2.8		12312
A4 QUATTRO VR6	98-01	6	2.8		12302
A4 TURBO	97-99	4	1.8		12304
A4 TURBO	00-08	4	1.8		12312
A4 TURBO	05-13	4	2.0		12312
A4 TURBO	12-13	4	1.8		12312
A4 TURBO	05-08	4	2.0		12302
A4 VR6	00-00	6	2.8		12312
A4 VR6	98-01	6	2.8		12302
A5	10-10	6	3.2		12312
A5 QUATTRO	12-13	6	3.0		12312
A5 QUATTRO	09-10	6	3.2		12312
A5 QUATTRO TURBO	10-13	4	2.0		12312
A5 TURBO	10-13	4	2.0		12312
A5 TURBO	12-13	4	1.8		12312
A6	05-05	6	3.0		12312
A6	07-09	6	3.2		12312
A6	08-12	6	2.8	12312	
A6	99-01	6	2.8	12302	
A6	02-05	6	3.0	12302	
A6 QUATTRO	05-05	6	3.0	12312	
A6 QUATTRO	07-09	6	3.2	12312	
A6 QUATTRO	05-11	8	4.2	12312	
A6 QUATTRO	09-13	6	3.0	12312	
A6 QUATTRO	01-05	8	4.2	12302	
A6 QUATTRO	05-05	6	3.0	12302	
A6 QUATTRO BITURBO	01-04	6	2.7	12302	
A6 QUATTRO VR6	01-01	6	2.8	12302	
A6 TURBO	13-14	4	2.0	12312	
A8 QUATTRO	04-12	8	4.2	12312	
A8 QUATTRO	06-10	12	6.0	12312	
A8 QUATTRO	12-13	12	6.3	12312	
A8 QUATTRO	00-04	8	4.2	12302	
A8 QUATTRO TURBO	12-13	6	3.0	12312	
A8 QUATTRO TURBO	13-13	8	4.0	12312	
ALLROAD QUATTRO BITURBO	01-04	6	2.7	12302	
Q5	10-12	6	3.2	12312	
Q5 TURBO	11-13	4	2.0	12312	
Q5 TURBO	13-13	6	3.0	12312	
Q7	07-10	6	3.6	12312	
Q7	07-10	8	4.2	12312	
Q7 TURBO	11-12	6	3.0	12312	
R8	08-12	8	4.2	12312	
R8	11-12	10	5.2	12312	
RS4	07-08	8	4.2	12312	
RS6 BITURBO	04-04	8	4.2	12302	
S4	09-09	8	4.2	12312	
S4 TURBO	10-13	6	3.0	12312	
S5	09-12	8	4.2	12312	
S5	09-09	8	4.2	12302	
S5 TURBO	12-13	6	3.0	12312	
S6	07-11	10	5.2	12312	
S6	13-13	6	4.0	12312	
S6	09-09	10	5.2	12302	
S7	13-13	6	4.0	12312	
S8	07-10	10	5.2	12312	
S8	09-09	10	5.2	12302	
S8 TURBO	13-13	8	4.0	12312	
TT QUATTRO	08-09	6	3.2	12312	
TT QUATTRO	04-06	6	3.2	12302	
TT QUATTRO TURBO	10-13	4	2.0	12312	
TT QUATTRO TURBO	12-13	4	2.5	12312	
TT QUATTRO TURBO	00-06	4	1.8	12302	
TT TURBO	08-10	4	2.0	12312	
TT TURBO	00-06	4	1.8	12302	

MPFI

CONTINÚA»

<b>CHRYSLER</b>					
MODELO	AÑO	CIL.	MOTOR	SISTEMA	No. PARTE
200	12-14	6	3.6		12334
300	12-15	6	3.6		12334
300	12-15	8	5.7		12334
300 SRT-8	12-14	8	6.4		12334
300M	01-04	6	3.5		12092
300M	99-00	6	3.5		12095
ASPEN	08-09	8	5.7		12334
CIRRUS	97-00	4	2.4		12095
CIRRUS	96-00	6	2.5		12095
CIRRUS	96-96	4	2.4		12014
CIRRUS	96-96	6	2.5		12014
CONCORDE	98-00	6	3.5		12095
CONCORDE	93-97	6	3.5		12014
GRAND VOYAGER	00-00	6	3.8		12095
GRAND VOYAGER	96-98	6	3.8		12052
GRAND VOYAGER	91-93	6	3.3		12014
LEBARON K TURBO	84-87	4	2.2		12014
LEBARON TURBO	92-94	4	2.5		12014
MAGNUM K	84-88	4	2.2		12014
NEW YORKER	91-93	4	2.5		12014
NEW YORKER LH	94-96	6	3.5	MPFI	12014
PACIFICA	04-06	6	3.5		12092
PACIFICA	07-07	6	3.8		12092
PACIFICA	07-07	6	4.0		12092
PACIFICA	08-08	6	4.0		12334
PHANTOM TURBO	87-89	4	2.2		12014
PHANTOM TURBO	90-94	4	2.5		12014
PT CRUISER	01-10	4	2.4		12092
TOWN & COUNTRY	11-16	6	3.6		12334
TOWN & COUNTRY	01-07	6	3.8		12092
TOWN & COUNTRY	98-00	6	3.8		12095
TOWN & COUNTRY	98-99	6	3.8		12052
TOWN & COUNTRY	08-08	6	4.0		12092
TOWN & COUNTRY	09-10	6	4.0		12334
TOWN & COUNTRY	93-93	6	3.3		12014
TOWN & COUNTRY	94-97	6	3.8		12014
VOYAGER	01-08	6	3.3		12092
VOYAGER	00-00	6	3.3		12095
VOYAGER	96-97	6	3.3		12052
VOYAGER	91-96	6	3.3		12014

<b>CHRYSLER</b>					<b>DODGE</b>
MODELO	AÑO	CIL.	MOTOR	SISTEMA	No. PARTE
ATOS	01-04	4	1.0		12305
ATOS	05-12	4	1.1		12305
ATTITUDE	06-11	4	1.4		12325
ATTITUDE	06-11	4	1.6		12325
AVENGER	09-10	6	3.5		12334
CHALLENGER	13-15	6	3.6		12334
CHALLENGER R/T	09-14	8	5.7		12334
CHALLENGER SC	15-15	8	6.2		12334
CHALLENGER SRT-8	08-10	8	6.1		12334
CHALLENGER SRT-8	11-15	8	6.4		12334
CHARGER	06-08	6	3.5		12092
CHARGER	09-10	6	3.5	MPFI	12334
CHARGER	11-13	6	3.6		12334
CHARGER R/T	08-15	8	5.7		12334
CHARGER R/T	06-07	8	5.7		12092
CHARGER SRT-8	07-07	8	6.1		12092
CHARGER SRT-8	08-10	8	6.1		12334
CHARGER SRT-8	15-15	8	6.2		12334
CHARGER SRT-8	12-14	8	6.4		12334
DAKOTA	05-08	6	3.7		12095
DAKOTA	09-10	6	3.7		12334
DAKOTA	07-07	8	4.7		12095
DART	13-13	4	2.0		12334

<b>CHRYSLER</b>					<b>DODGE</b>
MODELO	AÑO	CIL.	MOTOR	SISTEMA	No. PARTE
DART	13-13	4	2.4		12334
DURANGO	12-16	6	3.6		12334
DURANGO	08-09	8	4.7		12334
DURANGO	00-07	8	4.7		12095
DURANGO	98-00	8	5.2		12052
DURANGO	08-16	8	5.7		12334
DURANGO	04-07	8	5.7		12092
DURANGO	98-03	8	5.9		12052
H100 CHASIS	03-05	4	2.4		12313
H100 VAN	12-14	4	2.4		12311
i10	12-14	4	1.1		12338
INTREPID	98-98	6	2.7		12095
INTREPID	98-00	6	3.2		12095
INTREPID	99-99	6	3.2		12315
INTREPID	00-00	6	3.5		12095
INTREPID	00-00	6	3.5		12095
INTREPID	94-97	6	3.5		12014
JOURNEY R/T	09-10	6	3.5		12334
JOURNEY R/T	11-15	6	3.6		12334
NEON	00-05	4	2.0		12095
NEON	95-99	4	2.0	MPFI	12306
NEON SRT-4	04-05	4	2.4		12092
NITRO	07-07	6	3.7		12095
NITRO	08-11	6	3.7		12334
NITRO R/T	07-07	6	4.0		12095
NITRO R/T	08-08	6	4.0		12092
NITRO R/T	09-09	6	4.0		12334
RAM 1500	14-15	6	3.6		12334
RAM 1500	03-07	6	3.7		12095
RAM 1500	08-13	6	3.7		12334
RAM 1500	02-02	6	3.9		12095
RAM 1500	94-01	6	3.9		12052
RAM 2500	94-96	8	5.2		12052
RAM 2500	03-17	8	5.7		12334
RAM 2500	94-02	8	5.9		12052
RAM 2500	94-96	8	5.2		12014
RAM 2500	94-96	8	5.9		12014
RAM 2500	94-02	8	5.9		12052
RAM 3500	94-96	8	5.9		12014
RAMCHARGER	92-93	8	5.9		12052
RAMCHARGER	91-94	8	5.9	TBI	12014
SHADOW	91-94	4	2.5		12014
SHADOW GTS	89-90	4	2.2		12014
SPIRIT	91-94	4	2.5		12014
STRATUS	01-05	4	2.0		12092
STRATUS	97-00	4	2.0		12095
STRATUS	01-06	4	2.4	MPFI	12092
STRATUS	97-00	4	2.4		12095
STRATUS	95-96	4	2.0		12014
STRATUS	95-96	4	2.4		12014
VAN 1000	08-09	4	2.4		12313
VERNA	04-06	4	1.6		12311

<b>CHRYSLER</b>					<b>JEEP</b>
MODELO	AÑO	CIL.	MOTOR	SISTEMA	No. PARTE
CHEROKEE	14-15	4	2.4		12334
CHEROKEE	14-15	6	3.2		12334
CHEROKEE SPORT	98-01	6	4.0		12095
CHEROKEE SPORT	94-94	6	4.0		12014
COMMANDER	06-07	8	4.7		12095
COMMANDER	08-10	8	5.7	MPFI	12334
GRAND CHEROKEE	11-16	6	3.6		12334
GRAND CHEROKEE	05-07	6	3.7		12095
GRAND CHEROKEE	08-10	6	3.7		12334
GRAND CHEROKEE	97-04	6	4.0		12095
GRAND CHEROKEE	08-09	8	4.7		12334

CONTINÚA»



CHRYSLER		JEEP			
MODELO	AÑO	CIL.	MOTOR	SISTEMA	No. PARTE
GRAND CHEROKEE	99-07	8	4.7	MPFI	12095
GRAND CHEROKEE	93-98	8	5.2		12052
GRAND CHEROKEE	08-16	8	5.7		12334
GRAND CHEROKEE	05-07	8	5.7		12092
GRAND CHEROKEE	98-98	8	5.9		12052
GRAND CHEROKEE	93-96	6	4.0		12014
GRAND CHEROKEE SRT-8	08-10	8	6.1		12334
GRAND CHEROKEE SRT-8	12-16	8	6.4		12334
LIBERTY	02-07	6	3.7		12095
LIBERTY	08-12	6	3.7		12334
WRANGLER	03-06	4	2.4		12095
WRANGLER	93-97	4	2.5		12014
WRANGLER	97-02	4	2.5		12095
WRANGLER	12-15	6	3.6		12334
WRANGLER	07-07	6	3.8		12092
WRANGLER	09-11	6	3.8		12334
WRANGLER	98-06	6	4.0		12095

FIAT					
MODELO	AÑO	CIL.	MOTOR	SISTEMA	No. PARTE
500 SPORT	12-15	4	1.4	MPFI	12326
GRANDE PUNTO	07-09	4	1.4		12326
UNO	13-13	4	1.4		12326

FORD					
MODELO	AÑO	CIL.	MOTOR	SISTEMA	No. PARTE
AEROSTAR	91-94	6	3.0	MPFI	12011
AEROSTAR	91-95	6	4.0		12011
CONTOUR	95-95	4	2.0		12011
CONTOUR	99-99	4	2.0		12046
CONTOUR	95-95	6	2.5		12011
CONTOUR	96-98	4	2.0		12099
CONTOUR	96-00	6	2.5		12099
COURIER	01-12	4	1.6		12314
ECONOLINE E-150	97-03	6	4.2		12011
ECONOLINE E-150	04-10	8	4.6		12011
ECONOLINE E-150	95-95	6	4.9		12011
ECONOLINE E-150	97-03	6	4.2		12099
ECONOLINE E-150	95-96	6	4.9		12099
ECONOLINE E-250	97-03	6	4.2		12099
ECONOLINE E-250	99-03	8	5.4		12099
ECONOLINE E-350	97-03	8	5.4		12011
ECONOLINE E-350	97-03	8	5.4		12099
ECOSPORT	04-14	4	2.0		12309
ESCAPE	08-08	4	2.3		12011
ESCAPE	09-10	4	2.5		12011
ESCAPE	01-03	6	3.0		12309
ESCAPE	04-08	6	3.0		12332
ESCAPE	08-10	6	3.0		12011
ESCAPE	05-05	4	2.3		12099
ESCORT	99-01	4	2.0		12309
ESCORT	96-96	4	1.9		12099
ESCORT	97-01	4	2.0		12099
EXCURSION	01-05	10	6.8		12011
EXPEDITION	97-04	8	4.6		12011
EXPEDITION	05-14	8	5.4		12337
EXPEDITION	03-10	8	5.4		12011
EXPEDITION	97-02	8	4.6		12099
EXPEDITION	97-02	8	5.4	12099	
EXPLORER	02-10	6	4.0	12309	
EXPLORER	91-94	6	4.0	12011	
EXPLORER	95-10	6	4.0	12011	
EXPLORER	97-03	6	4.0	12046	
EXPLORER	02-04	8	4.6	12309	
EXPLORER	02-10	8	4.6	12011	
EXPLORER	96-01	8	5.0	12011	

FORD					
MODELO	AÑO	CIL.	MOTOR	SISTEMA	No. PARTE
EXPLORER	97-01	8	5.0	MPFI	12046
EXPLORER	95-00	6	4.0		12099
EXPLORER	06-10	8	4.6		12099
EXPLORER	96-00	8	5.0		12099
EXPLORER SPORT TRAC	07-10	6	4.6		12011
EXPLORER SPORT TRAC	08-10	8	4.6		12309
EXPLORER SPORT TRAC	07-07	8	4.6		12099
F-150	92-94	6	3.8		12011
F-150	02-09	6	4.2		12011
F-150	02-10	8	4.6		12011
F-150	94-95	6	4.9		12011
F-150	97-03	6	4.2		12099
F-150	96-97	6	4.9		12099
F-250	92-96	8	5.0		12011
F-250	97-99	8	4.6		12099
F-250	96-96	8	5.0		12099
F-250	96-97	8	5.8		12099
F-350	95-96	8	5.0		12011
F-350	96-97	8	5.0		12099
F-350	96-97	8	5.8		12099
F-350 SUPER DUTY	02-10	8	5.4		12011
F-350 SUPER DUTY	99-04	8	5.4		12099
F-450 SUPER DUTY	99-04	10	6.8		12099
F-550 SUPER DUTY	05-10	10	6.8		12011
F-550 SUPER DUTY	99-04	10	6.8		12099
FIESTA	03-13	4	1.6		12309
FIESTA	98-01	4	1.3		12099
FIESTA	98-00	4	1.4		12099
FIVE HUNDRED	05-07	6	3.0		12309
FOCUS	12-15	4	2.0		12309
FOCUS	02-05	4	2.0		12309
FOCUS	00-02	4	2.0		12301
FOCUS	00-01	4	2.0	12099	
FOCUS STATION WAGON	00-03	4	2.0	12301	
FOCUS ZX3	00-03	4	2.0	12301	
FREESTAR	04-07	6	4.2	12099	
FUSION	06-09	4	2.3	12046	
FUSION	13-13	4	2.5	12309	
FUSION	06-09	6	3.0	12332	
FUSION TURBO	13-16	4	2.0	12309	
GHIA	91-91	4	2.3	12011	
GHIA	92-94	6	3.0	12011	
IKON	01-07	4	1.6	12314	
KA	01-08	4	1.6	12314	
LOBO	05-07	8	4.6	12011	
LOBO	03-04	8	5.4	12099	
MICROBUS	92-95	8	5.0	12011	
MONDEO	01-05	4	2.0	12309	
MONDEO	02-05	6	2.5	12309	
MONDEO	06-07	6	2.5	12099	
MUSTANG	05-10	6	4.0	12309	
MUSTANG	05-05	8	4.6	12309	
MUSTANG	06-10	8	4.6	12337	
MUSTANG	94-95	8	5.0	12011	
MUSTANG	06-10	8	4.6	12099	
MUSTANG	96-04	8	4.6	12099	
MUSTANG SHELBY GT	08-12	8	5.4	12099	
RANGER	01-03	4	2.3	12046	
RANGER	04-06	4	2.3	12099	
RANGER	95-97	4	2.3	12099	
RANGER	98-02	6	3.0	12099	
TAURUS	88-91	6	3.8	12011	
THUNDERBIRD	89-95	6	3.8	12011	
THUNDERBIRD	95-95	8	4.6	12011	
THUNDERBIRD	91-93	8	5.0	12011	
THUNDERBIRD	96-96	6	3.8	12099	

# SENSORES DE TEMPERATURA DEL REFRIGERANTE (CTS)

FORD					
MODELO	AÑO	CIL.	MOTOR	SISTEMA	No. PARTE
THUNDERBIRD	96-96	8	4.6	MPFI	12099
THUNDERBIRD SC	89-95	6	3.8		12011
WINDSTAR	95-03	6	3.8		12099

FORD LINCOLN					
MODELO	AÑO	CIL.	MOTOR	SISTEMA	No. PARTE
AVIATOR	03-05	8	4.6	MPFI	12099
LS	04-06	8	3.9		12298
LS	04-05	4	3.0		12099
LS	00-03	4	3.9		12099
MARK LT	06-08	6	5.4		12337
MARK VIII	96-96	4	4.6		12099
MKZ	07-08	6	3.5		12332
MKZ	10-12	8	3.5		12099
MKZ TURBO	13-16	8	2.0		12309
NAVIGATOR	05-10	6	5.4		12337
NAVIGATOR	98-04	6	5.4		12099
TOWN CAR	91-94	8	4.6		12011
TOWN CAR	95-98	6	4.6		12099
ZEPHYR	06-06	6	3.0		12332

FORD MERCURY					
MODELO	AÑO	CIL.	MOTOR	SISTEMA	No. PARTE
COUGAR XR7	90-95	6	3.8	MPFI	12011
GRAND MARQUIS	92-04	8	4.6		12011
GRAND MARQUIS	95-98	8	4.6		12099
GRAND MARQUIS CFI	83-84	8	5.0		12011
MARINER	05-08	6	3.0		12332
MILAN	07-08	6	3.0		12332
MONTEGO	05-07	6	3.0		12309
MYSTIQUE	95-95	4	2.0		12011
MYSTIQUE	95-95	6	2.5		12011
MYSTIQUE	97-99	4	2.0		12046
MYSTIQUE	96-96	4	2.0		12099
MYSTIQUE	96-00	6	2.5		12099
SABLE	94-95	6	3.8		12011
SABLE	04-04	6	3.0		12309
SABLE	03-03	6	3.0		12332
SABLE	96-04	6	3.0		12099
TOPAZ	89-94	4	2.3		12011

GENERAL MOTORS BUICK					
MODELO	AÑO	CIL.	MOTOR	SISTEMA	No. PARTE
CENTURY	87-89	6	2.8	MPFI	12001
CENTURY	91-95	6	3.1		12001
ENCLAVE	10-15	6	3.6		12303
ENCORE TURBO	14-16	4	1.4		12327
LACROSSE	10-12	6	3.6		12303
REGAL	94-95	6	3.8		12001
REGAL	96-96	6	3.8		12299
VERANO	14-16	4	2.4		12027
VERANO TURBO	13-16	4	2.0		12027

GENERAL MOTORS CADILLAC					
MODELO	AÑO	CIL.	MOTOR	SISTEMA	No. PARTE
ATS TURBO	13-16	4	2.0	MPFI	12327
BLS	07-08	4	2.0		12303
CTS	12-13	8	6.2		12027
CTS	05-13	6	3.6		12303
DEVILLE	92-95	8	4.9		12001
ESCALADE	02-06	8	6.0		12027
ESCALADE	07-16	8	6.2		12027
ESCALADE	02-05	8	5.3		12027
ESCALADE ESV	07-16	8	6.2		12027
ESCALADE ESV	03-06	8	6.0		12027
ESCALADE EXT	07-13	8	6.2		12027

GENERAL MOTORS CADILLAC					
MODELO	AÑO	CIL.	MOTOR	SISTEMA	No. PARTE
ESCALADE EXT	03-06	8	6.0	MPFI	12027
SRX	04-06	6	3.6		12303
SRX	10-13	6	3.6		12303
STS	06-10	6	3.6		12303

GENERAL MOTORS CHEVROLET						
MODELO	AÑO	CIL.	MOTOR	SISTEMA	No. PARTE	
ASTRA	00-03	4	1.8	MPFI	12303	
ASTRA	07-08	4	1.8		12303	
ASTRA TURBO	07-08	4	2.0		12303	
AVALANCHE	02-13	8	5.3		12027	
AVEO	08-17	4	1.6		12027	
BEAT	18-18	4	1.2		12319	
BLAZER	95-01	6	4.3		12001	
BLAZER NEVADA	91-94	6	3.1		TBI	12001
C25	86-91	8	5.7		TBI	12001
C25 CON COPLÉ	88-93	8	5.7		MPFI	12500
C2500	94-98	8	5.7		MPFI	12001
C35	94-98	8	5.7		TBI	12001
C35 CON COPLÉ	88-93	8	5.7		MPFI	12500
C3500	94-98	8	5.7		TBI	12001
CAMARO	10-16	8	6.2		MPFI	12027
CAMARO	99-02	8	5.7	12027		
CAMARO	10-12	6	3.6	12303		
CAPTIVA SPORT	08-15	4	2.4	12027		
CAPTIVA SPORT	14-15	6	3.0	12027		
CAPTIVA SPORT	08-10	6	3.6	12303		
CAVALIER	95-02	4	2.2	12001		
CAVALIER	90-94	6	2.8	12001		
CAVALIER	02-04	4	2.2	12027		
CAVALIER Z24	96-97	4	2.4	12001		
CAVALIER Z24	91-94	6	3.1	12001		
CELEBRITY	87-89	6	2.8	12001		
CELEBRITY CON COPLÉ	82-84	6	2.8	12500		
CHEVY	96-03	4	1.6	12027		
CHEVY	96-03	4	1.6	TBI		12027
CHEVY	94-03	4	1.4	MPFI	12027	
CHEVY	96-03	4	1.4	MPFI	12027	
CHEVY	09-12	4	1.6	TBI	12027	
CHEVY C2	04-08	4	1.6	MPFI	12027	
CHEVY MONZA	96-03	4	1.6	TBI	12027	
CHEVY MONZA	96-03	4	1.6	MPFI	12027	
CHEVY PICK UP	99-03	4	1.6		12027	
CHEVY WAGON	00-03	4	1.6		12027	
CHEYENNE	10-13	8	5.3	12027		
CHEYENNE CUSTOM	92-99	8	5.7	TBI	12001	
CORSA	02-02	4	1.4	MPFI	12303	
CORSA	02-05	4	1.8		12303	
CORSA	06-08	4	1.8		12335	
CORVETTE	93-96	8	5.7		12001	
CORVETTE	97-04	8	5.7		12027	
CORVETTE	05-07	8	6.0		12027	
CORVETTE	08-13	8	6.2		12027	
CORVETTE CON COPLÉ	91-91	8	5.7		12500	
CRUZE	11-16	4	1.8		12327	
CRUZE TURBO	14-15	4	1.4		MPFI	12327
EQUINOX	05-08	6	3.4		12027	
EXPRESS 1500	98-06	6	4.3		12001	
EXPRESS 1500	03-13	8	5.3		12027	
EXPRESS 2500	00-02	8	5.7		12001	
EXPRESS 3500	00-02	8	5.7		12001	
EXPRESS 3500	03-13	8	6.0	12027		
HHR	06-09	4	2.4	12027		
LUV	98-01	4	2.2	12001		
MALIBU	97-02	4	2.4	12001		
MALIBU	97-03	6	3.1	12001		

CONTINÚA»

GENERAL MOTORS		CHEVROLET				
MODELO	AÑO	CIL.	MOTOR	SISTEMA	No. PARTE	
MALIBU	05-07	6	3.5	MPFI	12027	
MALIBU	04-07	4	2.2		12027	
MALIBU	08-12	4	2.4		12027	
MALIBU	09-12	6	3.6		12303	
MALIBU	13-15	4	2.5		12327	
MALIBU TURBO	13-15	4	2.0		12327	
MATIZ	11-15	4	1.0		12319	
MERIVA	04-05	4	1.8		12027	
MICROBUS	92-99	8	5.7		TBI	12001
OPTRA	06-10	4	2.0		MPFI	12027
P30	92-99	8	5.7		TBI	12001
S10	95-97	4	2.2		MPFI	12299
S10 MAXICAB	91-93	6	3.1		TBI	12001
SILVERADO 1500	99-08	6	4.3		MPFI	12001
SILVERADO 1500	08-10	6	4.3			12027
SILVERADO 2500	03-09	8	4.8	12001		
SILVERADO 2500	99-07	8	5.3	12027		
SILVERADO 3500	01-07	8	6.0	12027		
SILVERADO 3500	03-06	8	8.1	12320		
SONIC	12-17	4	1.6	12327		
SONIC RS	14-16	4	1.4	12327		
SONORA	00-02	8	5.7	12001		
SPARK CLASSIC	11-17	4	1.2	12319		
SUBURBAN	92-99	8	5.7	12001		
SUBURBAN	00-14	8	5.3	TBI		12027
SUBURBAN 2500	00-13	8	6.0	12027		
TAHOE	07-14	8	5.3	12027		
TORNADO	11-14	4	1.8	12027		
TORNADO	04-10	4	1.8	12335		
TRACKER	98-98	4	1.6	12298		
TRAIL BLAZER	06-06	8	5.3	12027		
TRAIL BLAZER EXT	03-06	8	5.3	12027		
TRAVERSE	09-15	6	3.6	12303		
TRAX	13-16	4	1.8	MPFI	12327	
TRAX TURBO	14-15	4	1.4	12327		
UPLANDER	07-09	6	3.9	12027		
UPLANDER	05-06	6	3.5	12027		
VECTRA	03-05	4	2.2	12027		
VENTURE	00-04	6	3.4	12001		
VENTURE	97-99	6	3.4	12299		
ZAFIRA	02-06	4	2.2	12027		
ZAFIRA	02-05	4	1.8	12303		

GENERAL MOTORS		GEO			
MODELO	AÑO	CIL.	MOTOR	SISTEMA	No. PARTE
TRACKER	93-95	4	1.6	MPFI	12298

GENERAL MOTORS		GMC			
MODELO	AÑO	CIL.	MOTOR	SISTEMA	No. PARTE
ACADIA	07-15	6	3.6	MPFI	12303
YUKON	07-09	8	5.3		12027
YUKON	07-15	8	6.2		12027

GENERAL MOTORS		HUMMER			
MODELO	AÑO	CIL.	MOTOR	SISTEMA	No. PARTE
H2	05-07	8	6.0	MPFI	12027
H2	08-09	8	6.2		12027
H3	08-10	8	5.3		12027
H3T	09-10	8	5.3		12027

GENERAL MOTORS		OLDSMOBILE			
MODELO	AÑO	CIL.	MOTOR	SISTEMA	No. PARTE
88	92-94	6	3.8	MPFI	12001
CUTLASS	87-88	6	2.8		12001
CUTLASS	89-95	6	3.1		12001
SILHOUETTE	91-94	6	3.1		TBI

GENERAL MOTORS		OLDSMOBILE			
MODELO	AÑO	CIL.	MOTOR	SISTEMA	No. PARTE
SILHOUETTE	91-94	6	3.8	TBI	12001

GENERAL MOTORS		PONTIAC			
MODELO	AÑO	CIL.	MOTOR	SISTEMA	No. PARTE
AZTEK	01-05	6	3.4	MPFI	12001
BONNEVILLE	94-97	6	3.8		12001
G3	07-09	4	1.6		12027
G5	07-09	4	2.2		12027
G5 GT	07-09	4	2.4		12027
G6	05-09	6	3.5		12027
G6	07-09	6	3.6		12303
GRAND AM	99-04	6	3.4		12001
GRAND PRIX	97-01	6	3.1		12299
GRAND PRIX SC	97-99	6	3.8		12001
GRAND PRIX SC	97-01	6	3.8		12299
MATIZ	04-10	4	1.0		12319
MONTANA	06-06	6	3.5		12027
MONTANA	06-09	6	3.9		12027
SOLSTICE	06-09	4	2.4		12027
SUNFIRE	97-02	4	2.4	12001	
SUNFIRE	02-05	4	2.2	12027	
TORRENT	06-09	6	3.4	12027	

HONDA					
MODELO	AÑO	CIL.	MOTOR	SISTEMA	No. PARTE
ACCORD	98-02	4	2.3	MPFI	12316
ACCORD	98-02	6	3.0		12316
ACCORD	96-97	4	2.2		12316
ACCORD	03-07	4	2.4		12317
ACCORD	03-07	6	3.0		12317
ACCORD	08-17	4	2.4		12323
ACCORD	08-17	6	3.5		12323
CIVIC	97-00	4	1.6		12316
CIVIC	01-05	4	1.7		12317
CIVIC	06-11	4	1.8		12317
CIVIC	12-15	4	1.8		12323
CIVIC HIBRIDO	12-13	4	1.5		12323
CIVIC HIBRIDO	09-09	4	1.3		12323
CIVIC SI	07-11	4	2.0		12317
CIVIC SI	12-15	4	2.4		12323
CR-V	02-06	4	2.4	12317	
CR-V	07-17	4	2.4	12323	
CR-V	17-17	4	1.5	12323	
CR-Z HIBRIDO	13-15	4	1.5	12323	
FIT	06-17	4	1.5	12323	
ODYSSEY	00-05	6	3.5	12316	
ODYSSEY	06-06	6	3.5	12317	
ODYSSEY	07-17	6	3.5	12323	
PILOT	03-04	6	3.5	12316	
PILOT	05-08	6	3.5	12317	
PILOT	09-15	6	3.5	12323	
RIDGELINE	07-08	6	3.5	12317	
RIDGELINE	09-14	6	3.5	12323	

HYUNDAI					
MODELO	AÑO	CIL.	MOTOR	SISTEMA	No. PARTE
SONATA	15-15	4	2.4	MPFI	12305

JAGUAR					
MODELO	AÑO	CIL.	MOTOR	SISTEMA	No. PARTE
S-TYPE	05-08	8	4.2	MPFI	12309
VANDEN PLAS	06-09	8	4.2		12309
XF	09-10	8	4.2		12309
XF	10-11	8	5.0		12332
XFR	10-11	8	5.0		12332
XJ	11-11	8	5.0		12332

CONTINÚA»

<b>JAGUAR</b>					
MODELO	AÑO	CIL.	MOTOR	SISTEMA	No. PARTE
XJ8	06-08	8	4.2	MPFI	12309
XJ8	04-04	8	4.2		12321
XJ8	01-02	8	4.0		12321
XJR	04-05	8	4.2		12321
XKR	07-09	8	4.2		12309
XKR	10-11	8	5.0		12332
X-TYPE	02-04	6	2.5		12321
X-TYPE	02-07	6	3.0	12321	

<b>MAZDA</b>					
MODELO	AÑO	CIL.	MOTOR	SISTEMA	No. PARTE
2	12-15	4	1.5	MPFI	12298
5	06-10	4	2.3		12331
5	12-15	4	2.5		12331
6	06-08	4	2.3		12331
6	09-13	4	2.5		12331
3 UBICADO EN EL MOTOR	06-13	4	2.0		12331
3 UBICADO EN EL MOTOR	06-09	4	2.3		12331
3 UBICADO EN EL MOTOR	10-13	4	2.5		12331
3 UBICADO EN EL RADIADOR	11-13	4	2.0		12298
3 UBICADO EN EL RADIADOR	11-13	4	2.5		12298
3 SPEED TURBO UBICADO EN EL RADIADOR	11-13	4	2.3		12298
CX-5	13-17	4	2.0		12298
CX-5	14-17	4	2.5		12298
CX-7	10-12	4	2.5		12331
CX-7 TURBO	07-11	4	2.3		12331
MX-5 MIATA	06-11	4	2.0		12331

<b>MINI</b>					
MODELO	AÑO	CIL.	MOTOR	SISTEMA	No. PARTE
COOPER	02-08	4	1.6	MPFI	12092

<b>MITSUBISHI</b>					
MODELO	AÑO	CIL.	MOTOR	SISTEMA	No. PARTE
ECLIPSE	03-05	6	3.0	MPFI	12330
ECLIPSE	06-09	6	3.8		12330
ENDEAVOR	04-08	6	3.8		12330
ENDEAVOR	10-10	6	3.8		12330
GALANT	04-09	4	2.4		12330
GALANT	03-03	6	3.0		12330
GALANT	04-09	6	3.8		12330
GRANDIS	07-09	4	2.4		12330
LANCER	04-15	4	2.0		12330
LANCER GTS	09-15	4	2.4		12330
LANCER RALLIART	05-06	4	2.4		12330
MONTERO	03-06	6	3.8		12330
MONTERO SPORT	03-04	6	3.5		12330
OUTLANDER	04-13	4	2.4		12330
OUTLANDER	07-13	6	3.0		12330

<b>NISSAN</b>					
MODELO	AÑO	CIL.	MOTOR	SISTEMA	No. PARTE
G37	12-13	6	3.7	MPFI	12089
I30	98-01	6	3.0		12053
I35	03-03	6	3.5		12053
Q45	01-01	8	4.1		12053
Q45	03-06	8	4.5		12053

<b>NISSAN</b>					
MODELO	AÑO	CIL.	MOTOR	SISTEMA	No. PARTE
240SX	93-93	4	2.4	MPFI	12024
240SX	98-98	4	2.4		12053
300ZX	91-95	6	3.0		12024
300ZX	96-96	6	3.0		12053
350Z	03-08	6	3.5		12053
370Z	09-15	6	3.7		12053

<b>NISSAN</b>					
MODELO	AÑO	CIL.	MOTOR	SISTEMA	No. PARTE
ALMERA	01-05	4	1.8	MPFI	12053
ALTIMA	96-01	4	2.4		12053
ALTIMA	02-16	6	3.5		12053
ALTIMA	02-16	4	2.5		12053
APRIO	08-10	4	1.6		12308
ARMADA	05-15	8	5.6		12053
ARMADA	17-17	8	5.6		12053
D21	93-96	4	2.4		12024
D21	02-08	4	2.4		12053
D21	97-01	4	2.4		12089
FRONTIER	02-10	4	2.4		12053
FRONTIER	01-04	6	3.3		12053
FRONTIER	11-14	4	2.4		12324
FRONTIER	08-14	6	4.0		12324
LUCINO GSE	96-00	4	1.6		12089
LUCINO GSR	96-00	4	2.0		12089
MARCH	12-18	4	1.6		12053
MAXIMA	91-94	6	3.0		12024
MAXIMA	02-15	6	3.5		12053
MAXIMA	95-01	6	3.0		12089
MICRA	05-07	4	1.4		12053
MURANO	04-14	6	3.5		12053
NP300	09-15	4	2.4		12324
NP300 TDI	09-15	4	2.5		12324
PATHFINDER	01-04	6	3.5		12053
PATHFINDER	97-00	6	3.3		12089
PATHFINDER	05-10	6	4.0		12089
PATHFINDER	11-12	6	4.0		12324
PATHFINDER	13-16	6	3.5		12324
PATHFINDER ARMADA	04-04	8	5.6		12053
PLATINA	02-10	4	1.6		12308
QUEST	99-02	6	3.3		12053
QUEST	04-09	6	3.5	12053	
QUEST	97-98	6	3.0	12053	
ROGUE	08-14	4	2.5	12053	
SENTRA	92-92	4	1.6	12024	
SENTRA	07-12	4	2.0	12053	
SENTRA	96-00	4	2.0	12053	
SENTRA	97-00	4	1.6	12053	
SENTRA	01-06	4	1.8	12089	
SENTRA	13-15	4	1.8	12089	
SENTRA SE-R	02-12	4	2.5	12053	
TIIDA	07-18	4	1.8	12053	
TIIDA	13-18	4	1.6	12053	
TITAN	04-15	8	5.6	12089	
TSUBAME	93-94	4	1.6	12024	
TSUBAME	98-04	4	1.6	12053	
TSURU III	93-95	4	1.6	12024	
TSURU III	93-95	4	1.6	12024	
TSURU III	96-16	4	1.6	12089	
TSURU III GSR 2000	94-96	4	2.0	12089	
URVAN	01-05	4	2.4	12089	
URVAN	06-07	4	2.4	12324	
URVAN	08-13	4	2.5	12324	
VERSA	12-18	4	1.6	12053	
XTERRA	00-04	4	2.4	12053	
XTERRA	00-04	6	3.3	12053	
XTERRA	05-07	6	4.0	12089	
X-TRAIL	02-14	4	2.5	12053	

<b>PEUGEOT</b>					
MODELO	AÑO	CIL.	MOTOR	SISTEMA	No. PARTE
206	02-05	4	1.4	MPFI	12310
206	02-05	4	1.6		12310
206	06-08	4	1.4		12318
206	06-08	4	1.6		12318

**SENSORES DE TEMPERATURA DEL REFRIGERANTE (CTS)**

PEUGEOT					
MODELO	AÑO	CIL.	MOTOR	SISTEMA	No. PARTE
306	02-02	4	1.8	MPFI	12310
306	02-02	4	2.0		12310
307	03-07	4	2.0		12310
307	07-08	4	2.0		12336
PARTNER	05-06	4	1.6		12318

PORSCHE					
MODELO	AÑO	CIL.	MOTOR	SISTEMA	No. PARTE
CAYENNE	04-06	6	3.2	MPFI	12312
CAYENNE	08-10	6	3.6		12312

RENAULT					
MODELO	AÑO	CIL.	MOTOR	SISTEMA	No. PARTE
CLIO	02-10	4	1.6	MPFI	12308
CLIO SPORT	02-06	4	2.0		12308
DUSTER	13-16	4	2.0		12308
KANGOO	04-06	4	1.6		12308
KANGOO	07-09	4	1.6		12322
MEGANE	01-03	4	2.0		12308
MEGANE II	08-10	4	1.6		12308
MEGANE II	04-10	4	2.0		12308
MEGANE II	04-09	4	2.0		12322
MEGANE II	08-10	4	1.6		12322
MEGANE II TURBO	05-09	4	2.0		12322
SANDERO	10-15	4	1.6		12308
SCALA	11-13	4	1.6		12089
SCENIC	01-05	4	2.0		12308
SCENIC II	06-08	4	2.0		12322
STEPWAY	10-15	4	1.6		12308

SAAB					
MODELO	AÑO	CIL.	MOTOR	SISTEMA	No. PARTE
9-3 TURBO	07-09	6	2.8	MPFI	12303

SEAT					
MODELO	AÑO	CIL.	MOTOR	SISTEMA	No. PARTE
ALHAMBRA TURBO	03-03	4	1.8	MPFI	12312
CORDOBA	03-07	4	2.0		12312
CORDOBA	06-07	4	1.6		12312
IBIZA	03-06	4	1.6		12307
IBIZA	03-08	4	2.0		12307
IBIZA	06-07	4	1.6		12312
IBIZA	09-15	4	2.0		12312
IBIZA	01-02	4	1.6		12302
LEON	07-11	4	2.0		12312
LEON TURBO	08-13	4	1.4		12312
LEON TURBO	03-06	4	1.8		12312
LEON TURBO	01-01	4	1.8		12302
TOLEDO TURBO	02-04	4	1.8		12312

SUBARU					
MODELO	AÑO	CIL.	MOTOR	SISTEMA	No. PARTE
FORESTER	07-08	4	2.5	MPFI	12315

TOYOTA					
MODELO	AÑO	CIL.	MOTOR	SISTEMA	No. PARTE
4RUNNER	03-04	8	4.7	MPFI	12321
4RUNNER	06-09	6	4.0		12333
4RUNNER	05-09	8	4.7		12333
CAMRY	02-06	6	3.0		12321
CAMRY	02-11	4	2.4		12333
CAMRY	07-16	6	3.5		12333
CAMRY	10-16	4	2.5		12333
COROLLA	06-08	4	1.8		12298
COROLLA	03-05	4	1.8		12321
COROLLA	09-16	4	1.8		12333

TOYOTA					
MODELO	AÑO	CIL.	MOTOR	SISTEMA	No. PARTE
COROLLA XRS	09-13	4	2.4	MPFI	12333
FJ CRUISER	08-13	6	4.0		12333
HIACE	06-16	4	2.7		12333
HIGHLANDER	08-16	6	3.5		12333
HILUX	06-06	4	2.7		12298
LAND CRUISER	09-09	8	5.7		12321
LAND CRUISER	04-07	8	4.7		12321
LAND CRUISER	08-08	8	5.7		12333
LAND CRUISER	10-11	8	5.7		12333
LAND CRUISER	13-16	8	5.7		12333
MATRIX	03-08	4	1.8		12298
MATRIX	09-10	4	1.8		12333
MATRIX	09-10	4	2.4		12333
MR2 SPYDER	05-05	4	1.8		12321
RAV4	04-08	4	2.4		12333
RAV4	09-12	6	3.5		12333
RAV4	09-17	4	2.5		12333
SEQUOIA	08-09	8	4.7		12333
SEQUOIA	08-16	8	5.7		12333
SEQUOIA	10-12	8	4.6		12333
SIENNA	04-06	6	3.3		12298
SIENNA	07-16	6	3.5		12333
SOLARA	05-06	6	3.3		12321
TACOMA	06-15	6	4.0		12333
TUNDRA	07-07	6	4.0		12333
TUNDRA	07-09	8	4.7		12333
TUNDRA	11-13	8	5.7		12333
YARIS	04-04	4	1.3		12315
YARIS	06-17	4	1.5		12333

VOLKSWAGEN					
MODELO	AÑO	CIL.	MOTOR	SISTEMA	No. PARTE
BEETLE	99-99	4	2.0	MPFI	12304
BEETLE	06-10	4	2.0		12312
BEETLE	06-10	5	2.5		12312
BEETLE	12-13	5	2.5		12312
BEETLE	98-06	4	2.0		12302
BEETLE	06-10	5	2.5		12302
BEETLE	12-13	5	2.5		12302
BEETLE TURBO	99-99	4	1.8		12304
BEETLE TURBO	12-16	4	2.0		12312
BEETLE TURBO	99-05	4	1.8		12302
BEETLE TURBO	12-13	4	2.0		12302
BORA	06-10	5	2.5		12312
BORA GLI	06-10	4	2.0		12312
COMBI	93-96	4	1.8		12098
COMBI TERMOSWITCH	89-01	4	1.8		12096
CROSSFOX	07-09	4	1.6		12307
CROSSFOX	11-17	4	1.6		12307
DERBY	95-09	4	1.8		12098
DERBY	01-03	4	2.0		12098
DERBY TERMOSWITCH	97-00	4	1.8		12096
EOS TURBO	10-10	4	2.0		12312
EUROVAN	01-03	5	2.5		12307
EUROVAN TDI	06-06	4	1.9		12312
EUROVAN VR6	01-03	6	2.8		12307
GOL	09-17	4	1.6		12312
GOLF A2	90-92	4	1.8		12300
GOLF A3	93-96	4	1.8		12098
GOLF A3	93-96	4	2.0		12098
GOLF A3 VR6	99-99	6	2.8		12302
GOLF A3 VR6 TERMOSWITCH	95-99	6	2.8		12096
GOLF A4	00-06	4	2.0		12302
GOLF A4 GTI	00-05	4	1.8		12302
GOLF A4 R32	04-04	6	3.2	12302	
GOLF A5 GTI	07-09	4	2.0	12312	

CONTINÚA»

# SENSORES DE TEMPERATURA DEL REFRIGERANTE (CTS)

VOLKSWAGEN					
MODELO	AÑO	CIL.	MOTOR	SISTEMA	No. PARTE
GOLF A6 GTI	10-13	4	2.0		12312
JETTA TERMOSWITCH	86-88	4	1.8		12096
JETTA A2 TERMOSWITCH	89-92	4	1.8		12096
JETTA A2 FBU	90-92	4	1.8		12300
JETTA A2 FBU TERMOSWITCH	90-92	4	1.8		12097
JETTA A3	93-96	4	1.8		12098
JETTA A3	93-96	4	2.0		12098
JETTA A3 TERMOSWITCH	93-94	4	1.8		12096
JETTA A3 TERMOSWITCH	93-94	4	2.0		12096
JETTA A3 VR6 TERMOSWITCH	94-99	6	2.8		12096
JETTA A4	00-10	4	2.0		12302
JETTA A4 CLASICO	10-15	4	2.0	MPFI	12312
JETTA A4 TURBO	00-05	4	1.8		12302
JETTA A4 VR6	99-04	6	2.8		12302
JETTA A6	11-16	5	2.5		12312
JETTA A6 GLI	12-16	4	2.0		12312
LUPO	05-09	4	1.6		12312
PASSAT	03-04	8	4.0		12312
PASSAT	06-10	6	3.6		12312
PASSAT	12-16	5	2.5		12312
PASSAT	12-16	6	3.6		12312
PASSAT TERMOSWITCH	92-93	4	2.0		12096
PASSAT CC	09-16	6	3.6		12312

VOLKSWAGEN					
MODELO	AÑO	CIL.	MOTOR	SISTEMA	No. PARTE
PASSAT CC TURBO	09-16	4	2.0		12312
PASSAT TURBO	99-99	4	1.8		12304
PASSAT TURBO	06-10	4	2.0		12312
PASSAT TURBO	00-06	4	1.8		12302
PASSAT VR6	99-05	6	2.8		12302
PASSAT VR6 TERMOSWITCH	96-97	6	2.8		12096
POINTER	98-09	4	1.8		12091
POINTER GTI	00-03	4	2.0		12091
POINTER PICK UP	99-08	4	1.8		12091
POLO	03-07	4	2.0		12307
POLO	03-07	4	1.6		12312
ROUTAN	09-10	6	3.8	MPFI	12334
ROUTAN	11-12	6	3.6		12334
SHARAN TURBO	03-04	4	1.8		12312
SPORT VAN	07-10	4	1.6		12312
TIGUAN TURBO	09-16	4	2.0		12312
TOUAREG	04-06	6	3.2		12312
TOUAREG	08-10	6	3.6		12312
TOUAREG TDI	07-07	10	4.9		12312
TOUAREG TDI	09-10	6	3.0		12312
TOUAREG TURBO	04-09	8	4.2		12312
VAN	03-09	4	1.8		12091
VENTO	14-17	4	1.6		12312

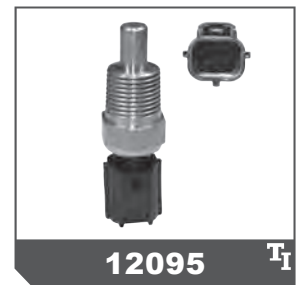
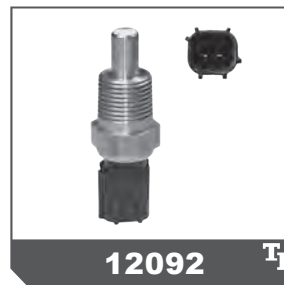
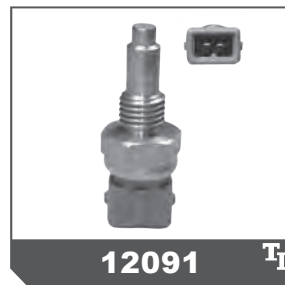
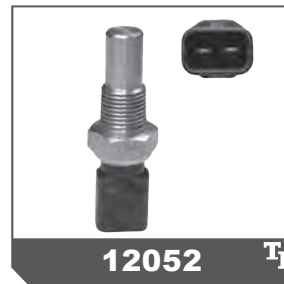
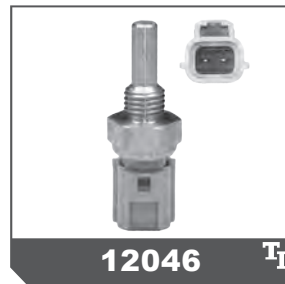
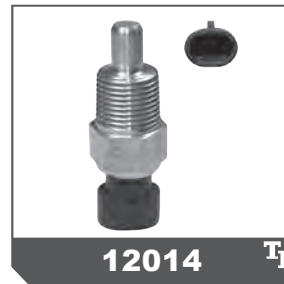



**SENSORES DE TEMPERATURA DEL REFRIGERANTE (CTS)**



**12096** <sup>TI</sup>



**12097** <sup>TI</sup>



**12098** <sup>TI</sup>



**12099** <sup>TI</sup>

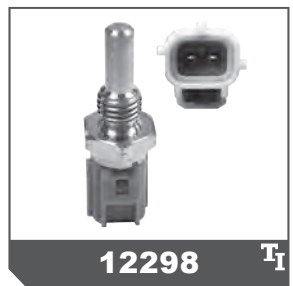

**12298** <sup>TI</sup>



**12299** <sup>TI</sup>



**12300** <sup>TI</sup>



**12301** <sup>TI</sup>



**12302** <sup>TI</sup>



**12303** <sup>TI</sup>



**12304** <sup>TI</sup>



**12305** <sup>TI</sup>



**12306** <sup>TI</sup>



**12307** <sup>TI</sup>



**12308** <sup>TI</sup>



**12309** <sup>TI</sup>



**12310** <sup>TI</sup>



**12311** <sup>TI</sup>



**12312** <sup>TI</sup>



**12313** <sup>TI</sup>



**12314** <sup>TI</sup>



**12315** <sup>TI</sup>



**12316** <sup>TI</sup>



**12317** <sup>TI</sup>

**SENSORES DE TEMPERATURA DEL REFRIGERANTE (CTS)**

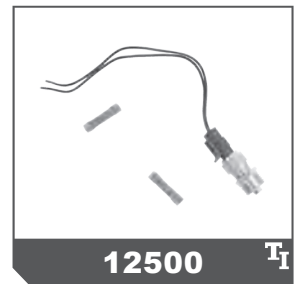
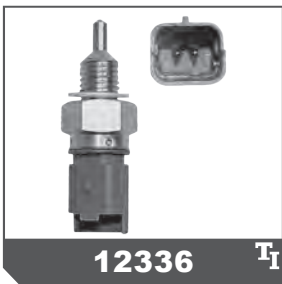
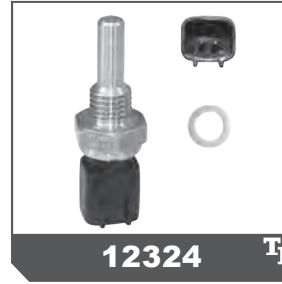
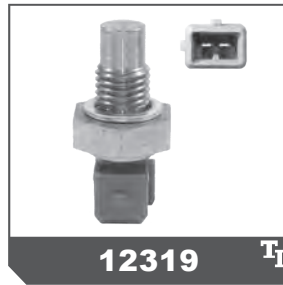

**SU FUNCIÓN: OLDSMOBILE**

Este sensor le enviará una señal al módulo de control según sea la velocidad del vehículo.

**SÍNTOMAS DE FALLA:**

Vehículo inestable, se apaga, se enciende la lámpara de servicio, no funciona el velocímetro y al acelerar el vehículo se jalonea.

**MANTENIMIENTO/SERVICIO:**

Revisar sus conexiones o la salida de señal del sensor. Se localiza en la transmisión del vehículo.

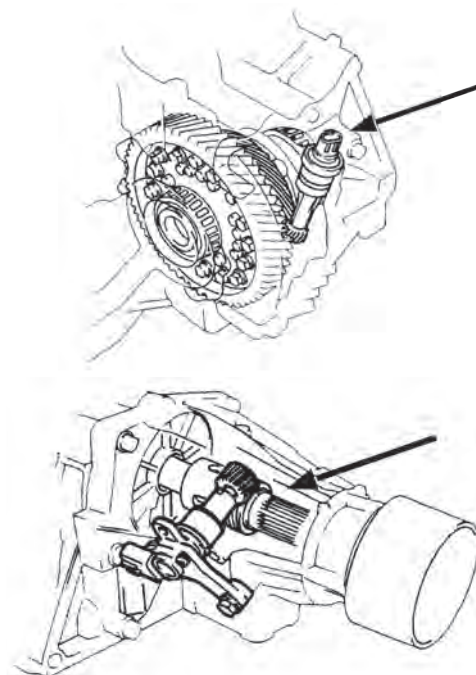

ACURA						
MODELO	AÑO	CIL.	MOTOR	SISTEMA	No. PARTE	
RL SALIDA TRANSMISIÓN	05-08	6	3.5	MPFI	31105	
TL ENTRADA TRANSMISIÓN	05-06	6	3.2		31104	

AUDI						
MODELO	AÑO	CIL.	MOTOR	SISTEMA	No. PARTE	
TT TURBO	00-02	4	1.8	MPFI	31978	

CHRYSLER						
MODELO	AÑO	CIL.	MOTOR	SISTEMA	No. PARTE	
300C ENTRADA TRANSMISIÓN	10-10	6	3.5	MPFI	31995	
300C ENTRADA TRANSMISIÓN	06-07	6	3.5		31995	
300M ENTRADA TRANSMISIÓN	99-04	6	3.5		31999	
300M SALIDA TRANSMISIÓN	99-04	6	3.5		31077	
CIRRUS	96-98	6	2.5		31074	
CIRRUS T/A	96-98	6	2.5		31999	
CIRRUS T/A	96-96	4	2.4		31999	
CIRRUS T/M	00-00	4	2.4		31074	
CIRRUS SALIDA TRANSMISIÓN T/A	96-96	6	2.5		31077	
GRAND VOYAGER ENTRADA TRANSMISIÓN T/A	96-02	6	3.8		31999	
GRAND VOYAGER SALIDA TRANSMISIÓN T/A	91-93	6	3.3		31077	
GRAND VOYAGER SALIDA TRANSMISIÓN T/A	96-02	6	3.8		31077	
GRAND VOYAGER	94-95	6	3.8		31074	
LEBARON TURBO	92-92	4	2.5		31063	
LEBARON TURBO	93-94	4	2.5		31074	

CHRYSLER						
MODELO	AÑO	CIL.	MOTOR	SISTEMA	No. PARTE	
NEW YORKER K	88-89	4	2.2	MPFI	31063	
NEW YORKER TURBO	93-94	4	2.5		31074	
PHANTOM TURBO	88-89	4	2.2		31063	
PHANTOM TURBO	93-94	4	2.5		31074	
PT CRUISER T/M	02-04	4	2.4		31074	
PT CRUISER ENTRADA TRANSMISIÓN T/A	01-04	4	2.4		31999	
PT CRUISER SALIDA TRANSMISIÓN T/A	01-04	4	2.4		31077	
TOWN & COUNTRY ENTRADA TRANSMISIÓN T/A	96-07	6	3.8		31999	
TOWN & COUNTRY SALIDA TRANSMISIÓN T/A	94-07	6	3.8		31077	
TOWN & COUNTRY T/A	94-95	6	3.8		31074	
TOWN & COUNTRY T/A	93-93	6	3.3		31074	
VOYAGER ENTRADA TRANSMISIÓN	94-00	6	3.3		31999	
VOYAGER SALIDA TRANSMISIÓN T/A	94-00	6	3.3		31077	

CHRYSLER							DODGE						
MODELO	AÑO	CIL.	MOTOR	SISTEMA	No. PARTE	MODELO	AÑO	CIL.	MOTOR	SISTEMA	No. PARTE		
ATOS	01-04	4	1.0	MPFI	31996	ATOS	05-12	4	1.1	31996			
ATOS	05-12	4	1.1		31996	ATTITUDE	12-14	4	1.6	31138			
ATTITUDE	12-14	4	1.6		31996	ATTITUDE	06-08	4	1.6	31996			
CHARGER ENTRADA TRANSMISIÓN	06-10	6	3.5		31995	CHARGER ENTRADA TRANSMISIÓN	06-10	6	3.5	31995			
DAKOTA ENTRADA TRANSMISIÓN	05-10	6	3.7		31995	DAKOTA ENTRADA TRANSMISIÓN	05-10	6	3.7	31995			
DAKOTA ENTRADA TRANSMISIÓN - T/A	07-07	8	4.7		31995	DAKOTA ENTRADA TRANSMISIÓN - T/A	07-07	8	4.7	31995			
DURANGO	98-00	8	5.2		31077	DURANGO	98-00	8	5.2	31077			
DURANGO	98-03	8	5.9		31077	DURANGO	98-03	8	5.9	31077			
DURANGO EN DIFERENCIAL	00-03	8	4.7		31124	DURANGO EN DIFERENCIAL	00-03	8	4.7	31124			
DURANGO EN DIFERENCIAL	98-00	8	5.2		31124	DURANGO EN DIFERENCIAL	98-00	8	5.2	31124			
DURANGO EN DIFERENCIAL	98-03	8	5.9		31124	DURANGO EN DIFERENCIAL	98-03	8	5.9	31124			
DURANGO ENTRADA TRANSMISIÓN	12-13	6	3.6		31995	DURANGO ENTRADA TRANSMISIÓN	12-13	6	3.6	31995			
DURANGO ENTRADA TRANSMISIÓN	00-07	8	4.7		31995	DURANGO ENTRADA TRANSMISIÓN	00-07	8	4.7	31995			
DURANGO ENTRADA TRANSMISIÓN	00-00	8	5.2		31995	DURANGO ENTRADA TRANSMISIÓN	00-00	8	5.2	31995			
DURANGO ENTRADA TRANSMISIÓN	12-13	8	5.7		31995	DURANGO ENTRADA TRANSMISIÓN	12-13	8	5.7	31995			
DURANGO ENTRADA TRANSMISIÓN	04-09	8	5.7		31995	DURANGO ENTRADA TRANSMISIÓN	04-09	8	5.7	31995			
DURANGO ENTRADA TRANSMISIÓN	00-03	8	5.9		31995	DURANGO ENTRADA TRANSMISIÓN	00-03	8	5.9	31995			
H100 VAN	12-14	4	2.4		31996	H100 VAN	12-14	4	2.4	31996			
i10	12-14	4	1.1		31996	i10	12-14	4	1.1	31996			
NEON	95-04	4	2.0		31074	NEON	95-04	4	2.0	31074			
NEON SRT-4	04-05	4	2.4		31074	NEON SRT-4	04-05	4	2.4	31074			
NITRO ENTRADA TRANSMISIÓN	07-11	6	3.7		31995	NITRO ENTRADA TRANSMISIÓN	07-11	6	3.7	31995			
RAM 1500	03-06	6	3.7		31077	RAM 1500	03-06	6	3.7	31077			
RAM 1500 EN DIFERENCIAL	03-05	6	3.7		31124	RAM 1500 EN DIFERENCIAL	03-05	6	3.7	31124			
RAM 1500 EN DIFERENCIAL	98-01	6	3.9		31124	RAM 1500 EN DIFERENCIAL	98-01	6	3.9	31124			
RAM 1500 ENTRADA TRANSMISIÓN	02-10	6	3.7		31995	RAM 1500 ENTRADA TRANSMISIÓN	02-10	6	3.7	31995			
RAM 1500 ENTRADA TRANSMISIÓN	02-02	6	3.9		31995	RAM 1500 ENTRADA TRANSMISIÓN	02-02	6	3.9	31995			
RAM 2500 EN DIFERENCIAL	03-05	8	5.7		31124	RAM 2500 EN DIFERENCIAL	03-05	8	5.7	31124			
RAM 2500 EN DIFERENCIAL	98-02	8	5.9		31124	RAM 2500 EN DIFERENCIAL	98-02	8	5.9	31124			
RAM 2500 ENTRADA TRANSMISIÓN	11-13	8	4.7		31995	RAM 2500 ENTRADA TRANSMISIÓN	11-13	8	4.7	31995			
RAM 2500 ENTRADA TRANSMISIÓN	02-05	8	4.7		31995	RAM 2500 ENTRADA TRANSMISIÓN	02-05	8	4.7	31995			
RAM 2500 ENTRADA TRANSMISIÓN	03-17	8	5.7		31995	RAM 2500 ENTRADA TRANSMISIÓN	03-17	8	5.7	31995			
RAM 2500 ENTRADA TRANSMISIÓN	02-02	8	5.9	31995	RAM 2500 ENTRADA TRANSMISIÓN	02-02	8	5.9	31995				
RAM 3500 EN DIFERENCIAL	98-02	8	5.9	31124	RAM 3500 EN DIFERENCIAL	98-02	8	5.9	31124				
RAM 3500 ENTRADA TRANSMISIÓN	02-02	8	5.9	31995	RAM 3500 ENTRADA TRANSMISIÓN	02-02	8	5.9	31995				
RAM VAN 1500 EN DIFERENCIAL	99-03	6	3.9	31124	RAM VAN 1500 EN DIFERENCIAL	99-03	6	3.9	31124				
RAM VAN 1500 ENTRADA TRANSMISIÓN	03-03	6	3.9	31995	RAM VAN 1500 ENTRADA TRANSMISIÓN	03-03	6	3.9	31995				
RAM VAN 2500 ENTRADA TRANSMISIÓN	03-03	8	5.2	31995	RAM VAN 2500 ENTRADA TRANSMISIÓN	03-03	8	5.2	31995				
RAM VAN 3500 ENTRADA TRANSMISIÓN	03-03	8	5.9	31995	RAM VAN 3500 ENTRADA TRANSMISIÓN	03-03	8	5.9	31995				
RAMCHARGER	97-01	8	5.9	31077	RAMCHARGER	97-01	8	5.9	31077				
SHADOW	91-92	4	2.5	31063	SHADOW	91-92	4	2.5	31063				
SHADOW	93-94	4	2.5	31074	SHADOW	93-94	4	2.5	31074				
SHADOW GTS	89-90	4	2.2	31063	SHADOW GTS	89-90	4	2.2	31063				
SPIRIT	91-92	4	2.5	31063	SPIRIT	91-92	4	2.5	31063				
SPIRIT	93-94	4	2.5	31074	SPIRIT	93-94	4	2.5	31074				
STRATUS	95-98	4	2.0	31074	STRATUS	95-98	4	2.0	31074				
STRATUS	95-98	4	2.4	31074	STRATUS	95-98	4	2.4	31074				
STRATUS T/A	95-96	4	2.0	31999	STRATUS T/A	95-96	4	2.0	31999				
STRATUS T/A	01-06	4	2.4	31999	STRATUS T/A	01-06	4	2.4	31999				

CONTINÚA»

<b>CHRYSLER</b>		<b>DODGE</b>			
MODELO	AÑO	CIL.	MOTOR	SISTEMA	No. PARTE
STRATUS T/A	95-96	4	2.4	MPFI	31999
STRATUS T/M	01-06	4	2.4		31077
VERNA	04-06	4	1.5		31996
VERNA	04-06	4	1.6		31996

<b>CHRYSLER</b>		<b>JEEP</b>			
MODELO	AÑO	CIL.	MOTOR	SISTEMA	No. PARTE
CHEROKEE SPORT	94-94	6	4.0	MPFI	31074
COMMANDER ENTRADA TRANSMISIÓN	06-10	8	5.7		31995
GRAND CHEROKEE	93-98	8	5.2		31074
GRAND CHEROKEE	00-03	6	4.0		31077
GRAND CHEROKEE ENTRADA TRANSMISIÓN	11-13	6	3.6		31995
GRAND CHEROKEE ENTRADA TRANSMISIÓN	99-99	6	4.0		31995
GRAND CHEROKEE ENTRADA TRANSMISIÓN	99-09	8	4.7		31995
GRAND CHEROKEE ENTRADA TRANSMISIÓN	05-13	8	5.7		31995
GRAND CHEROKEE	94-98	6	4.0		31074
GRAND CHEROKEE SRT-8 ENTRADA TRANSMISIÓN	06-09	8	6.1		31995
GRAND CHEROKEE SRT-8 ENTRADA TRANSMISIÓN	12-13	8	6.4	31995	
LIBERTY ENTRADA TRANSMISIÓN	02-12	6	3.7	31995	
WRANGLER ENTRADA TRANSMISIÓN	03-06	4	2.4	31995	
WRANGLER ENTRADA TRANSMISIÓN	07-11	6	3.8	31995	
WRANGLER ENTRADA TRANSMISIÓN	03-06	6	4.0	31995	

<b>FORD</b>					
MODELO	AÑO	CIL.	MOTOR	SISTEMA	No. PARTE
AEROSTAR C/ODOMETRO ELECTRONICO	91-95	6	4.0	MPFI	31030
AEROSTAR	91-95	6	3.0		31085
AEROSTAR EN DIFERENCIAL	91-95	6	3.0		31979
AEROSTAR EN DIFERENCIAL	91-95	6	4.0		31979
CONTOUR	95-00	6	2.5		31109
CONTOUR T/A	95-00	4	2.0		31111
CONTOUR T/M	97-98	4	2.0		31072
ECONOLINE E-150 EN DIFERENCIAL	97-03	6	4.2		31979
ECONOLINE E-150 EN DIFERENCIAL	04-06	8	4.6		31979
ECONOLINE E-150 EN DIFERENCIAL	95-96	6	4.9		31979
ECONOLINE E-150 SALIDA TRANSMISIÓN	01-03	6	4.2	31130	
ECONOLINE E-150 SALIDA TRANSMISIÓN	97-00	6	4.2	31300	
ECONOLINE E-150 SALIDA TRANSMISIÓN	95-96	6	4.9	31300	
ECONOLINE E-250 SALIDA TRANSMISIÓN	97-03	6	4.2	31979	
ECONOLINE E-250 SALIDA TRANSMISIÓN	01-03	6	4.2	31130	
ECONOLINE E-250 SALIDA TRANSMISIÓN	01-03	8	5.4	31130	
ECONOLINE E-250 SALIDA TRANSMISIÓN	97-00	6	4.2	31300	
ECONOLINE E-350 SALIDA TRANSMISIÓN	98-06	8	5.4	31979	
ECONOLINE E-350 SALIDA TRANSMISIÓN	01-02	8	5.4	31130	
ECOSPORT ENTRADA T/A	04-12	4	2.0	31983	
ESCAPE ENTRADA TRANSMISIÓN	01-08	6	3.0	31123	
ESCAPE SALIDA TRANSMISIÓN	01-08	6	3.0	31122	
ESCAPE SALIDA TRANSMISIÓN	05-08	4	2.3	31122	
ESCORT	94-96	4	1.9	31033	
ESCORT	98-98	4	2.0	31106	
ESCORT	97-97	4	2.0	31108	
ESCORT GT	94-95	4	1.8	31033	
EXCURSION EN DIFERENCIAL	01-05	10	6.8	31979	
EXPEDITION	01-03	8	4.6	31130	
EXPEDITION	01-03	8	5.4	31130	
EXPEDITION EN DIFERENCIAL	97-02	8	4.6	31979	
EXPEDITION EN DIFERENCIAL	97-02	8	5.4	31979	
EXPEDITION SALIDA TRANSMISIÓN	97-00	8	4.6	31300	
EXPEDITION SALIDA TRANSMISIÓN	97-00	8	5.4	31300	
EXPLORER EN DIFERENCIAL	91-01	6	4.0	31979	
EXPLORER EN DIFERENCIAL	96-01	8	5.0	31979	
EXPLORER SALIDA TRANSMISIÓN	02-10	6	4.0	31129	
EXPLORER SALIDA TRANSMISIÓN	02-10	8	4.6	31129	
EXPLORER SALIDA TRANSMISIÓN T/M	96-01	6	4.0	31300	
EXPLORER SALIDA TRANSMISIÓN T/M	96-01	8	5.0	31300	
F-150	01-03	6	4.2	31130	

<b>FORD</b>					
MODELO	AÑO	CIL.	MOTOR	SISTEMA	No. PARTE
F-150	01-03	8	4.6	MPFI	31130
F-150 EN DIFERENCIAL	97-03	6	4.2		31979
F-150 EN DIFERENCIAL	97-00	8	4.6		31979
F-150 EN DIFERENCIAL	94-97	6	4.9		31979
F-150 SALIDA TRANSMISIÓN	97-00	6	4.2		31300
F-150 SALIDA TRANSMISIÓN	97-00	8	4.6		31300
F-150 SALIDA TRANSMISIÓN	95-97	6	4.9		31300
F-250 EN DIFERENCIAL	98-04	8	4.6		31979
F-250 EN DIFERENCIAL	92-97	8	5.0		31979
F-250 EN DIFERENCIAL	87-97	8	5.8		31979
F-250 SALIDA TRANSMISIÓN	97-00	8	4.6	31300	
F-250 SALIDA TRANSMISIÓN	92-97	8	5.0	31300	
F-250 SALIDA TRANSMISIÓN	92-97	8	5.8	31300	
F-350 EN DIFERENCIAL	95-98	8	5.0	31979	
F-350 SUPER DUTY EN DIFERENCIAL	99-04	8	5.4	31979	
F-450 SUPER DUTY EN DIFERENCIAL	99-04	10	6.8	31979	
F-550 SUPER DUTY EN DIFERENCIAL	99-04	10	6.8	31979	
FIESTA	02-09	4	1.6	31109	
FIESTA	98-01	4	1.3	31109	
FIESTA	98-00	4	1.4	31109	
FOCUS	00-03	4	2.0	31072	
FOCUS	00-04	4	2.0	31135	
FOCUS EJE DE ENTRADA (T/A)	00-11	4	2.0	31983	
FOCUS ST EJE DE ENTRADA (T/A)	07-10	5	2.5	31983	
FREESTAR	04-07	6	4.2	31128	
IKON	02-09	4	1.6	31109	
KA	01-08	4	1.6	31109	
MONDEO EJE DE ENTRADA (T/A)	01-07	4	2.0	31983	
MUSTANG	96-98	8	4.6	31030	
MUSTANG	94-95	8	5.0	31030	
MUSTANG SALIDA TRANSMISIÓN	05-10	6	4.0	31129	
MUSTANG SALIDA TRANSMISIÓN	05-10	8	4.6	31129	
MUSTANG SALIDA TRANSMISIÓN	01-04	8	4.6	31130	
MUSTANG SALIDA TRANSMISIÓN	96-00	8	4.6	31300	
MUSTANG SALIDA TRANSMISIÓN	94-95	8	5.0	31300	
MUSTANG SHELBY GT SALIDA TRANSMISIÓN	08-10	8	5.4	31129	
RANGER	96-97	4	2.3	31030	
RANGER	96-97	6	3.0	31085	
RANGER EN DIFERENCIAL	96-97	4	2.3	31979	
RANGER EN DIFERENCIAL	01-09	4	2.3	31979	
RANGER EN DIFERENCIAL	96-02	6	3.0	31979	
TAURUS	88-91	6	3.8	31030	
THUNDERBIRD	95-95	8	4.6	31030	
THUNDERBIRD	85-95	6	3.8	31031	
THUNDERBIRD SALIDA TRANSMISIÓN	03-03	8	3.9	31129	
THUNDERBIRD SC	89-95	6	3.8	31030	
WINDSTAR	01-03	6	3.8	31128	

<b>FORD</b>		<b>LINCOLN</b>			
MODELO	AÑO	CIL.	MOTOR	SISTEMA	No. PARTE
AVIATOR SALIDA TRANSMISIÓN	03-05	8	4.6	MPFI	31129
LS SALIDA TRANSMISIÓN	06-06	8	3.9		31129
NAVIGATOR EN DIFERENCIAL	98-02	8	5.4		31979

<b>FORD</b>		<b>MERCURY</b>			
MODELO	AÑO	CIL.	MOTOR	SISTEMA	No. PARTE
COUGAR XR7	90-95	6	3.8	MPFI	31030
GRAND MARQUIS	93-01	8	4.6		31030
GRAND MARQUIS C/CONTROL DE VELOCIDAD	92-92	8	4.6		31031
MARINER ENTRADA TRANSMISIÓN	05-08	6	3.0		31123
MARINER SALIDA TRANSMISIÓN	05-08	6	3.0		31122
MYSTIQUE	97-98	4	2.0		31072
MYSTIQUE	95-95	4	2.0		31111
MYSTIQUE T/A	95-00	6	2.5		31109
SABLE	95-98	6	3.0		31030

FORD		MERCURY			
MODELO	AÑO	CIL.	MOTOR	SISTEMA	No. PARTE
SABLE	95-95	6	3.8	MPFI	31030
SABLE	01-04	6	3.0		31128
TOPAZ	90-94	4	2.3		31022

GENERAL MOTORS		BUICK			
MODELO	AÑO	CIL.	MOTOR	SISTEMA	No. PARTE
CENTURY T/A	89-89	6	2.8	MPFI	31013
CENTURY T/A	91-95	6	3.1		31013
CENTURY SALIDA TRANSMISIÓN T/A	94-95	6	3.1		31006
REGAL SALIDA TRANSMISIÓN T/A	94-96	6	3.8		31006

GENERAL MOTORS		CADILLAC			
MODELO	AÑO	CIL.	MOTOR	SISTEMA	No. PARTE
DEVILLE SALIDA TRANSMISIÓN	92-95	8	4.9	MPFI	31006
ESCALADE T/A	02-06	8	6.0		31061

GENERAL MOTORS		CHEVROLET				
MODELO	AÑO	CIL.	MOTOR	SISTEMA	No. PARTE	
ASTRA	00-03	4	1.8	MPFI	31987	
AVALANCHE	02-08	8	5.3		31061	
AVEO T/M	08-17	4	1.6		31984	
BLAZER	96-01	6	4.3	TBI	31061	
BLAZER NEVADA T/A	91-94	6	3.1		31057	
BLAZER NEVADA T/M	91-94	6	3.1	TBI	31113	
C2500	94-98	8	5.7	MPFI	31051	
C35 T/M	90-93	8	5.7		31087	
C3500	94-98	8	5.7	TBI	31051	
C3500	94-95	8	5.7	MPFI	31057	
C3500	96-98	8	5.7		31087	
CAMARO	96-02	8	5.7		31061	
CAMARO T/A	95-96	8	5.7		31057	
CAVALIER T/A	90-94	6	2.8		31013	
CAVALIER T/A	96-04	4	2.2		31047	
CAVALIER T/M	95-01	4	2.2		31029	
CAVALIER T/M	90-94	6	2.8		31029	
CAVALIER ENTRADA TRANSMISIÓN	02-04	4	2.2		31060	
CAVALIER Z24	96-97	4	2.4		31029	
CAVALIER Z24 T/A	92-93	6	3.1		31013	
CAVALIER Z24 T/M	91-94	6	3.1		31029	
CELEBRITY T/A	89-89	6	2.8		31013	
CELEBRITY T/M	89-89	6	2.8		31029	
CHEYENNE CUSTOM	92-99	8	5.7		TBI	31051
CHEYENNE CUSTOM T/A	92-95	8	5.7		MPFI	31057
CORSA	03-05	4	1.8			31987
CORVETTE T/A	94-96	8	5.7			31057
EXPRESS 1500	03-08	8	5.3			31057
EXPRESS 1500	00-01	6	4.3			31061
HHR ENTRADA TRANSMISIÓN	06-06	4	2.4	31060		
LUMINA SALIDA TRANSMISIÓN	96-96	6	3.4	31006		
MALIBU	97-01	4	2.4	31029		
MALIBU	09-12	6	3.6	31116		
MALIBU T/A	97-03	6	3.1	31047		
MALIBU T/A	04-06	6	3.5	31047		
MALIBU ENTRADA TRANSMISIÓN	04-07	6	3.5	31060		
MALIBU ENTRADA TRANSMISIÓN	97-03	6	3.1	31060		
MALIBU ENTRADA TRANSMISIÓN	08-12	4	2.4	31060		
MERIVA	04-05	4	1.8	31987		
MICROBUS	92-99	8	5.7	TBI	31051	
P30	92-99	8	5.7		31051	
S10	96-01	4	2.2	TBI	31087	
S10 MAXICAB T/A	91-93	6	3.1		31057	
S10 MAXICAB T/M	91-98	6	3.1		31113	
SILVERADO 1500	99-14	6	4.3		31061	

GENERAL MOTORS		CHEVROLET				
MODELO	AÑO	CIL.	MOTOR	SISTEMA	No. PARTE	
SILVERADO 2500	03-13	8	4.8	MPFI	31997	
SILVERADO 2500	99-11	8	5.3		31997	
SILVERADO 2500 RWD	01-03	8	5.3		31132	
SILVERADO 3500 RWD	01-05	8	6.0		31132	
SILVERADO 3500 RWD	01-05	8	8.1		31132	
SILVERADO 3500 HD	04-07	8	8.1		31997	
SUBURBAN	92-99	8	5.7		TBI	31051
SUBURBAN	92-95	8	5.7		MPFI	31057
SUBURBAN	96-99	8	5.7			31087
SUBURBAN 1500	00-06	8	5.3			31061
SUBURBAN 1500	07-14	8	5.3	31997		
SUBURBAN 2500	00-06	8	6.0	31061		
SUBURBAN 2500	07-13	8	6.0	31997		
TAHOE	07-14	8	5.3	31061		
TRAIL BLAZER	02-07	6	4.2	31061		
TRAIL BLAZER	02-07	6	4.2	31997		
TRAVERSE	09-15	6	3.6	31116		
VENTURE ENTRADA/SALIDA TRANSMISIÓN	97-98	6	3.4	31006		

GENERAL MOTORS		GMC			
MODELO	AÑO	CIL.	MOTOR	SISTEMA	No. PARTE
ACADIA	09-15	6	3.6	MPFI	31116

GENERAL MOTORS		OLDSMOBILE			
MODELO	AÑO	CIL.	MOTOR	SISTEMA	No. PARTE
88 SALIDA TRANSMISIÓN	92-95	6	3.8	MPFI	31006
CUTLASS	89-96	6	3.1		31013
CUTLASS T/M	89-94	6	3.1		31029
CUTLASS SALIDA TRANSMISIÓN	95-96	6	3.1	TBI	31006
SILHOUETTE T/A	91-94	6	3.1		31057
SILHOUETTE T/A	91-94	6	3.8		31057
SILHOUETTE T/M	91-94	6	3.8		31113
SILHOUETTE T/M	91-94	6	3.1		31113
SILHOUETTE SALIDA TRANSMISIÓN	92-94	6	3.1		31006
SILHOUETTE SALIDA TRANSMISIÓN	94-95	6	3.8	MPFI	31006

GENERAL MOTORS		PONTIAC			
MODELO	AÑO	CIL.	MOTOR	SISTEMA	No. PARTE
BONNEVILLE SALIDA TRANSMISIÓN	94-99	6	3.8	MPFI	31006
G3	07-09	4	1.6		31984
GRAND AM	99-01	6	3.4		31047
GRAND PRIX SALIDA TRANSMISIÓN	97-99	6	3.1		31006
GRAND PRIX SC SALIDA TRANSMISIÓN	97-01	6	3.8		31006
MONTANA ENTRADA TRANSMISIÓN	05-06	6	3.5		31060
MONTANA ENTRADA TRANSMISIÓN	06-06	6	3.9		31060
SUNFIRE	97-05	4	2.2		31047
SUNFIRE T/M	97-01	4	2.4		31029
SUNFIRE ENTRADA TRANSMISIÓN	03-05	4	2.2		31060
SUNFIRE ENTRADA TRANSMISIÓN	02-02	4	2.4		31060

HONDA					
MODELO	AÑO	CIL.	MOTOR	SISTEMA	No. PARTE
ACCORD	96-97	4	2.2	MPFI	31118
ACCORD	98-02	4	2.3		31989
ACCORD ENTRADA TRANSMISIÓN	03-07	4	2.4		31104
ACCORD ENTRADA TRANSMISIÓN	03-07	6	3.0		31104
ACCORD SALIDA TRANSMISIÓN	03-07	4	2.4		31105
CIVIC ENTRADA TRANSMISIÓN	06-11	4	1.8		31992
CIVIC ENTRADA TRANSMISIÓN	01-04	4	1.7		31992
CIVIC EX	97-00	4	1.6		31990
CIVIC EX	98-00	4	1.6		31991
CIVIC HIBRIDO ENTRADA TRANSMISIÓN	06-11	4	1.3		31992
CIVIC SI ENTRADA TRANSMISIÓN	07-09	4	2.0		31992
CR-V ENTRADA TRANSMISIÓN	02-06	4	2.4		31992
ODYSSEY ENTRADA TRANSMISIÓN	05-06	6	3.5		31104
ODYSSEY ENTRADA TRANSMISIÓN	02-04	6	3.5		31992



<b>HONDA</b>					
MODELO	AÑO	CIL.	MOTOR	SISTEMA	No. PARTE
PILOT ENTRADA TRANSMISIÓN	03-05	6	3.5	MPFI	31992

<b>HYUNDAI</b>					
MODELO	AÑO	CIL.	MOTOR	SISTEMA	No. PARTE
ELANTRA	15-16	4	1.8	MPFI	31996

<b>LAND ROVER</b>					
MODELO	AÑO	CIL.	MOTOR	SISTEMA	No. PARTE
LR4 SALIDA TRANSMISIÓN	11-13	8	5.0	MPFI	31129
RANGE ROVER SALIDA TRANSMISIÓN	11-12	8	5.0		31129
RANGE ROVER SALIDA TRANSMISIÓN	11-13	8	5.0		31129

<b>MITSUBISHI</b>					
MODELO	AÑO	CIL.	MOTOR	SISTEMA	No. PARTE
GALANT T/A	03-03	6	3.0	MPFI	31126
LANCER T/M	04-07	4	2.0		31126
LANCER RALLIART T/M	05-06	4	2.4		31126

<b>NISSAN</b>					
MODELO	AÑO	CIL.	MOTOR	SISTEMA	No. PARTE
ALMERA	02-03	4	1.8	MPFI	31137
ALTIMA	07-16	4	2.5		31134
ALTIMA	11-16	6	3.5		31134
ALTIMA T/A	96-97	4	2.4		31137
D21	04-08	4	2.4		31986
FRONTIER	02-02	6	3.3		31986
JUKE TURBO	12-17	4	1.6		31134
MAXIMA	11-15	6	3.5		31134
MURANO	04-14	6	3.5		31134
NP300	09-15	6	2.4		31986
PATHFINDER	13-16	6	3.5		31134
PLATINA	02-10	4	1.6		31127
QUEST ENTRADA TRANSMISIÓN	97-98	6	3.0		31125
QUEST ENTRADA TRANSMISIÓN	99-00	6	3.3		31125
ROGUE	08-14	4	2.5		31134
SENTRA	07-12	4	2.0		31134
SENTRA	13-15	4	1.8		31134
SENTRA T/A	96-99	4	1.6		31136
SENTRA T/A	00-01	4	2.0		31137
SENTRA SE-R	02-06	4	2.5		31117
SENTRA SE-R	07-12	4	2.5	31134	
TIIDA	07-18	4	1.8	31134	
TSURU III T/A	95-99	4	1.6	31136	
VERSA	12-18	4	1.6	31134	
XTERRA	01-01	6	3.3	31986	
X-TRAIL	08-14	4	2.5	31134	

<b>PEUGEOT</b>					
MODELO	AÑO	CIL.	MOTOR	SISTEMA	No. PARTE
206	00-08	4	1.4	MPFI	31982

<b>RENAULT</b>					
MODELO	AÑO	CIL.	MOTOR	SISTEMA	No. PARTE
CLIO T/M	02-10	4	1.6	MPFI	31127
KANGOO	07-13	4	1.6		31127

<b>SEAT</b>					
MODELO	AÑO	CIL.	MOTOR	SISTEMA	No. PARTE
LEON	06-06	4	2.0	MPFI	31978
LEON TURBO	01-06	4	1.8		31978

<b>TOYOTA</b>					
MODELO	AÑO	CIL.	MOTOR	SISTEMA	No. PARTE
4RUNNER	06-09	6	4.0	MPFI	31131
4RUNNER	03-09	8	4.7		31131
CAMRY	04-11	4	2.4		31988

<b>TOYOTA</b>					
MODELO	AÑO	CIL.	MOTOR	SISTEMA	No. PARTE
CAMRY	02-02	6	3.0	MPFI	31988
CAMRY	05-06	6	3.0		31988
CAMRY T/M	02-04	4	2.4		31120
CAMRY T/A	02-04	4	2.4		31119
COROLLA	09-16	4	1.8		31131
COROLLA SALIDA TRANSMISIÓN T/M	03-08	4	1.8		31121
COROLLA XRS	11-13	4	2.4		31131
COROLLA XRS	09-10	4	2.4		31988
FJ CRUISER	08-13	6	4.0		31131
FJ CRUISER SALIDA TRANSMISIÓN T/M	08-09	6	4.0		31121
HILUX SALIDA TRANSMISIÓN	04-08	4	2.7		31121
LAND CRUISER SALIDA TRANSMISIÓN	04-07	8	4.7		31121
MATRIX	03-10	4	1.8		31131
MATRIX SALIDA TRANSMISIÓN T/M	03-08	4	1.8		31121
RAV4	06-08	4	2.4		31988
RAV4 T/M	04-05	4	2.4		31120
RAV4 (T/A)	04-05	4	2.4		31119
SEQUOIA	08-09	8	4.7		31131
SEQUOIA	10-12	8	4.6		31131
SEQUOIA	10-10	8	5.7		31131
TACOMA	06-10	6	4.0	31131	
TACOMA SALIDA TRANSMISIÓN T/M	06-09	6	4.0	31121	
TUNDRA	07-07	6	4.0	31131	
TUNDRA	07-09	8	4.7	31131	
YARIS ENTRADA TRANSMISIÓN T/A	07-17	4	1.5	31131	
YARIS SALIDA TRANSMISIÓN T/A	07-12	4	1.5	31119	
YARIS SALIDA TRANSMISIÓN T/M	07-10	4	1.5	31121	

<b>VOLKSWAGEN</b>					
MODELO	AÑO	CIL.	MOTOR	SISTEMA	No. PARTE
BEETLE T/M	02-05	4	2.0	MPFI	31978
BEETLE T/M	06-10	5	2.5		31978
BEETLE SALIDA TRANSMISIÓN	99-05	4	2.0		31133
BEETLE TURBO T/A	99-05	4	1.8		31978
BEETLE TURBO SALIDA TRANSMISIÓN	99-05	4	1.8		31133
DERBY	03-06	4	1.8		31978
GOLF A4 T/M	00-06	4	2.0		31978
GOLF A4 SALIDA TRANSMISIÓN	00-06	4	2.0		31133
GOLF A4 GTI T/M	00-05	4	1.8		31978
GOLF A4 GTI SALIDA TRANSMISIÓN	00-05	4	1.8		31133
GOLF A4 R32 SALIDA TRANSMISIÓN	04-04	6	3.2		31133
JETTA A3 T/M	93-99	4	1.8		31981
JETTA A3 T/M	93-99	4	2.0		31981
JETTA A4 T/M	99-10	4	2.0		31978
JETTA A4 SALIDA TRANSMISIÓN	99-04	4	2.0		31133
JETTA A4 CLASICO T/M	10-15	4	2.0		31978
JETTA A4 TURBO T/M	99-05	4	1.8		31978
JETTA A4 TURBO SALIDA TRANSMISIÓN	99-04	4	1.8		31133
JETTA A4 VR6 T/M	99-04	6	2.8		31978
JETTA A4 VR6 SALIDA TRANSMISIÓN	99-04	6	2.8		31133



**SENSORES DE VELOCIDAD (VSS)**





**SENSORES DE VELOCIDAD (VSS)**

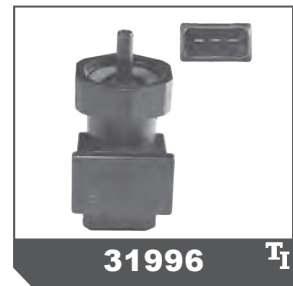
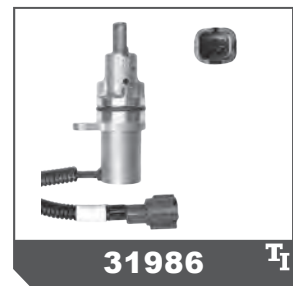

AUDI					
MODELO	AÑO	CIL.	MOTOR	SISTEMA	No. PARTE
A3 TURBO	00-04	4	1.8	MPFI	8750
A4 TURBO	00-06	4	1.8		8750

SEAT					
MODELO	AÑO	CIL.	MOTOR	SISTEMA	No. PARTE
CORDOBA	03-06	4	2.0	MPFI	8750
IBIZA	03-08	4	2.0		8750

VOLKSWAGEN					
MODELO	AÑO	CIL.	MOTOR	SISTEMA	No. PARTE
BEETLE	99-05	4	2.0	MPFI	8750
BEETLE TURBO	99-05	4	1.8		8750
GOLF A4	00-05	4	2.0		8750
GOLF A4 GTI	00-05	4	1.8		8750
JETTA A4	01-05	4	2.0		8750
JETTA A4 TURBO	00-05	4	1.8		8750



## SENSORES DE OXÍGENO

### SU FUNCIÓN:

Medir la cantidad de oxígeno en el escape después de la combustión y mandar la señal a la computadora para ajustar la mezcla de aire/gasolina.

### SÍNTOMAS DE FALLA:

Una baja salida de voltaje o reacción muy lenta, causa un rendimiento y economía muy pobres, alta emisión en hidrocarburos.

### MANTENIMIENTO/SERVICIO:

Hacer chequeos de emisiones periódicos. Reemplazar de acuerdo a las especificaciones de los fabricantes de vehículos a cada 40,000-50,000 kms. Revisar si prende la luz de "chechar motor".

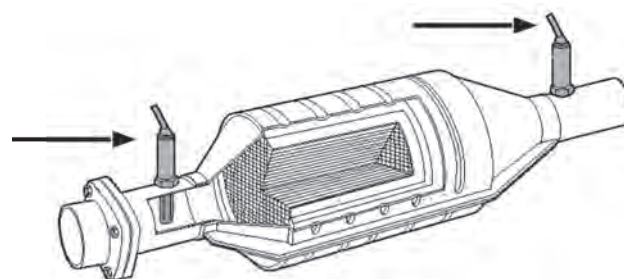

- **A/F** (AIR FUEL RATIO SENSOR)
- **S/C** (SIN CONECTOR)
- **5 CAB.** (5 CABLES)

ACURA					
MODELO	AÑO	CIL.	MOTOR	SISTEMA	No. PARTE
ILX (ANTES DEL C.C.) / <b>A/F</b> / <b>NUEVO</b>	13-15	4	2.0	MPFI	11868
MDX (ANTES DEL C.C.) / <b>A/F</b> / <b>5 CAB.</b>	05-06	6	3.5		11997
MDX (DESPUÉS DEL C.C.) - DELANTERO	10-13	6	3.7		11679
RDX (DESPUÉS DEL C.C.) - DELANTERO	13-17	6	3.5		11681
RDX TURBO (ANTES DEL C.C.) / <b>A/F</b>	07-12	4	2.3		11897
RL (ANTES DEL C.C.) / <b>A/F</b> / <b>5 CAB.</b>	05-08	6	3.5		11997
TL (ANTES DEL C.C.) / <b>A/F</b> / <b>5 CAB.</b>	05-08	6	3.2		11997
TL (DESPUÉS DEL C.C.) - DELANTERO	12-13	6	3.5		11679
TL (DESPUÉS DEL C.C.) - DELANTERO	12-13	6	3.7		11679
TSX (ANTES DEL C.C.) / <b>A/F</b>	09-13	4	2.4		11897
ZDX (DESPUÉS DEL C.C.) - DELANTERO	11-11	6	3.7	11679	

AUDI					
MODELO	AÑO	CIL.	MOTOR	SISTEMA	No. PARTE
A3 (ANTES DEL C.C.) <b>5 CAB.</b>	09-15	4	1.4	MPFI	11904
A3 (ANTES DEL C.C.) <b>5 CAB.</b>	08-15	4	1.8		11904
A3 (ANTES DEL C.C.)	00-01	4	1.8		11923
A3 (ANTES DEL C.C.) <b>5 CAB.</b>	07-13	4	2.0		11904
A3 TURBO DESPUÉS DEL C.C.	00-01	4	1.8		11922
A4 (ANTES DEL C.C.) <b>5 CAB.</b>	06-06	4	1.8		11904
A4 (ANTES DEL C.C.)	97-98	4	1.8		11921
A4 (ANTES DEL C.C.)	99-01	4	1.8		11923
A4 DESPUÉS DEL C.C.	06-06	4	1.8		11980
A4 QUATTRO VR6 DESPUÉS DEL C.C.	98-99	6	2.8		11920
A4 TURBO (DESPUÉS DEL C.C.)	97-98	4	1.8		11920
A4 TURBO (DESPUÉS DEL C.C.)	99-01	4	1.8		11922
A4 VR6 (DESPUÉS DEL C.C.)	01-03	6	2.8		11919

AUDI					
MODELO	AÑO	CIL.	MOTOR	SISTEMA	No. PARTE
A4 VR6 (DESPUÉS DEL C.C.)	96-99	6	2.8	MPFI	11920
A4 VR6 (ANTES DEL C.C.)	98-00	6	2.8		11921
A6 (DESPUÉS DEL C.C.)	99-99	6	2.8		11920
A6 QUATTRO VR6 DESPUÉS DEL C.C.	99-99	6	2.8		11920

BMW					
MODELO	AÑO	CIL.	MOTOR	SISTEMA	No. PARTE
323i (DESPUÉS DEL C.C.)	99-01	4	2.0	MPFI	11917
323i (ANTES DEL C.C.)	99-01	4	2.0		11926
323i (DESPUÉS DEL C.C.)	99-01	6	2.5		11917
323i (ANTES DEL C.C.)	99-01	6	2.5		11918
325i (DESPUÉS DEL C.C.)	01-05	6	2.5		11917
325i (ANTES DEL C.C.)	01-05	6	2.5		11926
328i (DESPUÉS DEL C.C.)	96-01	6	2.8		11917
328i (ANTES DEL C.C.)	96-01	6	2.8		11926
330i (DESPUÉS DEL C.C.)	01-05	6	3.0		11917
330i (ANTES DEL C.C.)	01-05	6	3.0		11926

CHRYSLER					
MODELO	AÑO	CIL.	MOTOR	SISTEMA	No. PARTE
200 (ANTES DEL C.C.)	12-14	4	2.4	MPFI	11901
200 (DESPUÉS DEL C.C.)	15-15	4	2.4		11994
200 (DESPUÉS DEL C.C.)	12-15	6	3.6		11994
300 (ANTES DEL C.C.)	12-14	6	3.6		11901
300 (DESPUÉS DEL C.C.)	12-15	6	3.6		11994
300 (ANTES DEL C.C.)	12-13	8	5.7		11901
300 (DESPUÉS DEL C.C.)	13-15	8	5.7		11994

CONTINÚA»

**SENSORES DE OXÍGENO**

**A/F (AIR FUEL RATIO SENSOR)**

**S/C (SIN CONECTOR)**

**5 CAB. (5 CABLES)**

CATÁLOGO INYECCIÓN 2019

<b>CHRYSLER</b>					
MODELO	AÑO	CIL.	MOTOR	SISTEMA	No. PARTE
300 SRT-8 (DESPUÉS DEL C.C.)	12-14	8	6.4		11994
300C (DESPUÉS DEL C.C.) - DERECHO	05-10	8	5.7		11905
300C (ANTES DEL C.C.)	05-06	8	5.7		11961
300C SRT-8 (DESPUÉS DEL C.C.) - DERECHO	06-08	8	6.1		11905
300C SRT-8 (ANTES DEL C.C.)	06-06	8	6.1		11961
CIRRUS (ANTES DEL C.C.) Y (DESPUÉS DEL C.C.) NUEVO	07-10	4	2.4		11865
CIRRUS (ANTES DEL C.C.) <b>S/C</b>	99-00	6	2.5		11022
CIRRUS (ANTES DEL C.C.) <b>S/C</b>	96-98	6	2.5		11022
CIRRUS (DESPUÉS DEL C.C.) <b>S/C</b>	96-98	6	2.5		11022
CIRRUS (DESPUÉS DEL C.C.) <b>S/C</b>	99-00	6	2.5		11022
CIRRUS (ANTES DEL C.C.)	99-00	6	2.5		11144
CIRRUS (ANTES DEL C.C.)	96-98	6	2.5		11151
CIRRUS (DESPUÉS DEL C.C.)	96-98	6	2.5		11159
CIRRUS (DESPUÉS DEL C.C.)	99-00	6	2.5		11161
CONCORDE (ANTES DEL C.C.) <b>S/C</b>	93-97	6	3.5		11022
CONCORDE (DESPUÉS DEL C.C.) - DERECHO <b>S/C</b>	96-97	6	3.5		11022
CONCORDE (DESPUÉS DEL C.C.) - IZQUIERDO <b>S/C</b>	96-97	6	3.5		11022
CONCORDE (ANTES DEL C.C.)	93-97	6	3.5		11030
CONCORDE (DESPUÉS DEL C.C.) - DERECHO	96-97	6	3.5		11143
CONCORDE (DESPUÉS DEL C.C.) - IZQUIERDO	96-97	6	3.5		11157
CONCORDE (ANTES DEL C.C.)	93-97	6	3.5		11915
GRAND VOYAGER (ANTES DEL C.C.) <b>S/C</b>	91-93	6	3.3		11022
GRAND VOYAGER (ANTES DEL C.C.)	91-93	6	3.3		11030
GRAND VOYAGER (ANTES DEL C.C.) <b>S/C</b>	94-97	6	3.8		11022
GRAND VOYAGER (DESPUÉS DEL C.C.) <b>S/C</b>	01-02	6	3.8		11022
GRAND VOYAGER (ANTES DEL C.C.) <b>S/C</b>	98-02	6	3.8		11022
GRAND VOYAGER (ANTES DEL C.C.)	94-97	6	3.8		11030
GRAND VOYAGER (DESPUÉS DEL C.C.)	01-02	6	3.8		11144
GRAND VOYAGER (ANTES DEL C.C.)	98-00	6	3.8		11151
GRAND VOYAGER (ANTES DEL C.C.)	01-02	6	3.8		11973
LEBARON K (ANTES DEL C.C.)	87-87	4	2.2		11017
LEBARON TURBO (ANTES DEL C.C.) <b>S/C</b>	92-94	4	2.5	MPFI	11022
LEBARON TURBO (ANTES DEL C.C.)	92-94	4	2.5		11030
NEW YORKER (ANTES DEL C.C.) S/C	91-94	4	2.5		11022
NEW YORKER (ANTES DEL C.C.)	91-94	4	2.5		11030
NEW YORKER K (ANTES DEL C.C.)	87-88	4	2.2		11017
NEW YORKER LH (ANTES DEL C.C.) S/C	94-95	6	3.5		11022
NEW YORKER LH (ANTES DEL C.C.)	94-95	6	3.5		11030
PACIFICA (ANTES DEL C.C.) <b>NUEVO</b>	07-07	6	3.8		11865
PACIFICA (ANTES DEL C.C.)	07-08	6	4.0		11955
PHANTOM TURBO (ANTES DEL C.C.) <b>S/C</b>	91-94	4	2.5		11022
PHANTOM TURBO (ANTES DEL C.C.)	91-94	4	2.5		11030
PT CRUISER (ANTES DEL C.C.)	04-09	4	2.4		11955
TOWN & COUNTRY (ANTES DEL C.C.) <b>S/C</b>	93-93	6	3.3		11022
TOWN & COUNTRY (ANTES DEL C.C.)	93-93	6	3.3		11030
TOWN & COUNTRY (ANTES DEL C.C.)	11-16	6	3.6		11901
TOWN & COUNTRY (ANTES DEL C.C.) <b>S/C</b>	94-96	6	3.8		11022
TOWN & COUNTRY (DESPUÉS DEL C.C.) <b>S/C</b>	01-03	6	3.8		11022
TOWN & COUNTRY (ANTES DEL C.C.) <b>S/C</b>	98-00	6	3.8		11022
TOWN & COUNTRY (ANTES DEL C.C.)	94-96	6	3.8		11030
TOWN & COUNTRY (DESPUÉS DEL C.C.)	01-03	6	3.8		11144
TOWN & COUNTRY (ANTES DEL C.C.)	98-00	6	3.8		11151
TOWN & COUNTRY (ANTES DEL C.C.) <b>NUEVO</b>	05-07	6	3.8		11865
TOWN & COUNTRY (DESPUÉS DEL C.C.)	04-07	6	3.8		11905
TOWN & COUNTRY (ANTES DEL C.C.)	01-03	6	3.8		11973
TOWN & COUNTRY (ANTES DEL C.C.) / (DESPUÉS DEL C.C.)	08-10	6	4.0		11955
VOYAGER (ANTES DEL C.C.) <b>S/C</b>	94-00	6	3.3		11022
VOYAGER (DESPUÉS DEL C.C.) <b>S/C</b>	01-03	6	3.3		11022
VOYAGER (ANTES DEL C.C.) <b>S/C</b>	01-03	6	3.3		11022
VOYAGER (ANTES DEL C.C.)	94-95	6	3.3		11030
VOYAGER (DESPUÉS DEL C.C.)	01-03	6	3.3		11144
VOYAGER (ANTES DEL C.C.)	96-00	6	3.3		11151
VOYAGER (ANTES DEL C.C.)	00-00	6	3.3		11915
VOYAGER (ANTES DEL C.C.)	01-03	6	3.3		11973

<b>CHRYSLER</b>		<b>DODGE</b>			
MODELO	AÑO	CIL.	MOTOR	SISTEMA	No. PARTE
ATOS (ANTES DEL C.C.)	01-04	4	1.0		11969
ATOS (ANTES DEL C.C.)	05-12	4	1.1		11969
ATTITUDE (ANTES DEL C.C. / DESPUÉS DEL C.C.)	06-08	4	1.4		11958
ATTITUDE (ANTES DEL C.C. / DESPUÉS DEL C.C.)	06-08	4	1.6		11958
AVENGER (ANTES DEL C.C.)	11-13	4	2.4		11901
AVENGER (ANTES DEL C.C. / DESPUÉS DEL C.C.) <b>NUEVO</b>	08-10	4	2.4		11865
AVENGER (ANTES DEL C.C. / DESPUÉS DEL C.C.)	08-09	6	3.5		11955
CALIBER (ANTES DEL C.C. / DESPUÉS DEL C.C.) <b>NUEVO</b>	07-07	4	2.0		11865
CALIBER (ANTES DEL C.C. / DESPUÉS DEL C.C.) <b>NUEVO</b>	07-10	4	2.4		11865
CALIBER (ANTES DEL C.C.)	11-12	4	2.4		11901
CHALLENGER (DESPUES DEL C.C.)	11-15	6	3.6		11994
CHALLENGER RT (DESPUES DEL C.C.)	13-14	8	5.7		11994
CHALLENGER SRT-8 (DESPUES DEL C.C.)	13-15	8	6.4		11994
CHARGER (DESPUES DEL C.C. / DERECHO)	07-10	6	3.5		11905
CHARGER (DESPUES DEL C.C.)	11-13	6	3.6		11994
CHARGER RT (DESPUES DEL C.C. / DERECHO)	07-14	8	5.7		11905
CHARGER RT (ANTES DEL C.C.)	06-14	8	5.7		11961
CHARGER SRT-8 (DESPUES DEL C.C. / DERECHO)	07-10	8	6.1		11905
CHARGER SRT-8 (ANTES DEL C.C.)	06-07	8	6.1		11994
CHARGER SRT-8 (DESPUES DEL C.C.)	13-14	8	6.4		11994
DAKOTA (ANTES DEL C.C.)	05-05	6	3.7		11961
DAKOTA (DESPUES DEL C.C. / IZQUIERDO)	05-10	6	3.7		11905
DAKOTA (ANTES DEL C.C.)	05-10	6	3.7		11955
DAKOTA (ANTES DEL C.C. / DERECHO / DESPUÉS DEL C.C.)	11-12	6	3.7		11905
DAKOTA (ANTES DEL C.C.)	11-12	6	3.7		11955
DART (DESPUES DEL C.C.)	13-13	4	2.0		11994
DART (DESPUES DEL C.C.)	13-15	4	2.4		11994
DURANGO (ANTES DEL C.C.)	12-14	6	3.6		11901
DURANGO (DESPUES DEL C.C.)	12-15	6	3.6		11994
DURANGO (ANTES DEL C.C.) <b>S/C</b>	99-02	8	5.2		11022
DURANGO (ANTES DEL C.C.)	05-14	8	5.7		11955
DURANGO (DESPUES DEL C.C.)	12-15	8	5.7	MPFI	11994
DURANGO (DESPUES DEL C.C. / IZQUIERDO)	04-04	8	5.7		11684
DURANGO (ANTES DEL C.C. / DERECHO)	05-06	8	5.7		11961
DURANGO (ANTES DEL C.C. / IZQUIERDO)	01-03	8	5.9		11905
DURANGO (ANTES DEL C.C.)	02-03	8	5.9		11955
DURANGO (ANTES DEL C.C.) <b>S/C</b>	99-02	8	5.9		11022
H100 CHASIS (ANTES DEL C.C.)	03-05	4	2.4		11954
i10 (ANTES DEL C.C. / DESPUÉS DEL C.C.)	12-14	4	1.1		11969
INTREPID (ANTES DEL C.C.) <b>S/C</b>	94-97	6	3.5		11022
INTREPID (ANTES DEL C.C.)	94-97	6	3.5		11030
INTREPID (DESPUES DEL C.C. / DERECHO) <b>S/C</b>	96-97	6	3.5		11022
INTREPID (DESPUES DEL C.C. / IZQUIERDO) <b>S/C</b>	96-97	6	3.5		11022
INTREPID (DESPUES DEL C.C. / DERECHO)	96-97	6	3.5		11143
INTREPID (DESPUES DEL C.C. / IZQUIERDO)	96-97	6	3.5		11157
JOURNEY (ANTES DEL C.C.)	09-17	4	2.4		11901
JOURNEY RT (ANTES DEL C.C.)	11-17	6	3.6		11901
JOURNEY RT (DESPUES DEL C.C.)	11-17	6	3.6		11994
NEON ÚNICO <b>S/C</b>	95-95	4	2.0		11022
NEON (ANTES DEL C.C.)	00-02	4	2.0		11151
NEON (DESPUES DEL C.C.) <b>S/C</b>	00-05	4	2.0		11022
NEON (ANTES DEL C.C.) <b>S/C</b>	00-05	4	2.0		11022
NEON (DESPUES DEL C.C.)	00-05	4	2.0		11144
NEON (DESPUES DEL C.C.) <b>S/C</b>	96-97	4	2.0		11022
NEON (ANTES DEL C.C.)	96-97	4	2.0		11030
NEON (DESPUES DEL C.C.)	96-97	4	2.0		11160
NEON (ANTES DEL C.C. / DESPUÉS DEL C.C.) <b>S/C</b>	98-99	4	2.0		11022
NEON (ANTES DEL C.C. / DESPUÉS DEL C.C.)	98-99	4	2.0		11151
NEON SRT-4 (ANTES DEL C.C. / DESPUÉS DEL C.C.)	04-05	4	2.4		11955
NEON ÚNICO ÚNICO	95-95	4	2.0		11030
PROMASTER 1500 (ANTES DEL C.C.)	14-17	6	3.6		11994
PROMASTER 2500 (ANTES DEL C.C.)	14-17	6	3.6		11994
PROMASTER 3500 (ANTES DEL C.C.)	14-17	6	3.6		11994
RAM 1500 (ANTES DEL C.C.)	14-15	6	3.6		11994
RAM 1500 (DESPUES DEL C.C.)	02-03	6	3.7		11684

CONTINÚA



# SENSORES DE OXÍGENO

**A/F** (AIR FUEL RATIO SENSOR)

**S/C** (SIN CONECTOR)

**5 CAB.** (5 CABLES)

<b>CHRYSLER</b>		<b>DODGE</b>				
MODELO	AÑO	CIL.	MOTOR	SISTEMA	No. PARTE	
RAM 1500 (ANTES DEL C.C.) <b>S/C</b>	03-03	6	3.7		11022	
RAM 1500 (DESPUES DEL C.C.) <b>S/C</b>	03-03	6	3.7		11022	
RAM 1500 (ANTES DEL C.C.)	03-03	6	3.7		11960	
RAM 1500 (DESPUES DEL C.C.)	03-03	6	3.7		11962	
RAM 1500 (ANTES DEL C.C.)	05-06	6	3.7		11961	
RAM 1500 (ANTES DEL C.C.)	05-09	6	3.7		11955	
RAM 1500 (ANTES DEL C.C.)	11-11	6	3.7		11905	
RAM 1500 (DESPUES DEL C.C.)	01-02	6	3.9		11684	
RAM 1500 (DESPUES DEL C.C.)	96-01	6	3.9		11161	
RAM 1500 (ANTES DEL C.C.) <b>S/C</b>	96-02	6	3.9		11022	
RAM 1500 (DESPUES DEL C.C.) <b>S/C</b>	96-02	6	3.9		11022	
RAM 1500 (ANTES DEL C.C.)	96-02	6	3.9		11151	
RAM 2500 (ANTES DEL C.C.)	11-13	8	4.7		11901	
RAM 2500 (ANTES DEL C.C.)	05-09	8	4.7		11955	
RAM 2500 (ANTES DEL C.C.) <b>S/C</b>	94-95	8	5.2		11022	
RAM 2500 (ANTES DEL C.C.)	94-95	8	5.2		11028	
RAM 2500 (ANTES DEL C.C. / DESPUES DEL C.C.) / (IZQUIERDO) <b>S/C</b>	96-98	8	5.2		11022	
RAM 2500 (ANTES DEL C.C. / DESPUES DEL C.C. / DERECHO) <b>S/C</b>	96-98	8	5.2		11022	
RAM 2500 (ANTES DEL C.C. / DESPUES DEL C.C.) / (IZQUIERDO)	96-98	8	5.2		11151	
RAM 2500 (ANTES DEL C.C. / DESPUES DEL C.C.) / DERECHO)	96-98	8	5.2		11161	
RAM 2500 (ANTES DEL C.C.) <b>S/C</b>	99-02	8	5.2		11022	
RAM 2500 (DESPUES DEL C.C.)	12-15	8	5.7		11994	
RAM 2500 (DESPUES DEL C.C.)	04-04	8	5.7		11684	
RAM 2500 (ANTES DEL C.C.)	05-09	8	5.7		11961	
RAM 2500 (DESPUES DEL C.C.)	05-10	8	5.7		11905	
RAM 2500 (ANTES DEL C.C. / DESPUES DEL C.C. / DERECHO)	11-11	8	5.7		11905	
RAM 2500 (DESPUES DEL C.C.)	01-02	8	5.9		11684	
RAM 2500 (ANTES DEL C.C.)	02-03	8	5.9		11955	
RAM 2500 (ANTES DEL C.C. / DESPUES DEL C.C.) <b>S/C</b>	03-03	8	5.9		11022	
RAM 2500 (ANTES DEL C.C. / DESPUES DEL C.C.)	03-03	8	5.9		11962	
RAM 2500 (ANTES DEL C.C.) <b>S/C</b>	94-95	8	5.9		11022	
RAM 2500 (ANTES DEL C.C.)	94-95	8	5.9		11028	
RAM 2500 (ANTES DEL C.C. / DESPUES DEL C.C.) / (IZQUIERDO) <b>S/C</b>	96-98	8	5.9		11022	
RAM 2500 (ANTES DEL C.C. / DESPUES DEL C.C. / DERECHO) <b>S/C</b>	96-98	8	5.9	MPFI	11022	
RAM 2500 (ANTES DEL C.C. / DESPUES DEL C.C.) / (IZQUIERDO)	96-98	8	5.9		11151	
RAM 2500 (ANTES DEL C.C. / DESPUES DEL C.C. / DERECHO)	96-98	8	5.9		11161	
RAM 2500 (ANTES DEL C.C.) S/C	99-02	8	5.9		11022	
RAM 3500 (DESPUES DEL C.C.)	01-02	8	5.9		11684	
RAM 3500 (ANTES DEL C.C.) <b>S/C</b>	99-02	8	5.9		11022	
RAM 4000 (ANTES DEL C.C.)	05-09	8	5.7		11955	
RAM 4000 (ANTES DEL C.C.) <b>S/C</b>	99-02	8	5.9		11022	
RAM 4000 (ANTES DEL C.C.)	99-02	8	5.9		11994	
RAM VAN 1500 (ANTES DEL C.C.)	96-01	6	3.9		11151	
RAM VAN 1500 (DESPUES DEL C.C.)	96-01	6	3.9		11161	
RAM VAN 2500 (ANTES DEL C.C. / DESPUES DEL C.C.) / (IZQUIERDO)	96-98	8	5.2		11151	
RAM VAN 2500 (ANTES DEL C.C. / DESPUES DEL C.C.)	96-98	8	5.2		11161	
RAM VAN 3500 (ANTES DEL C.C. / DESPUES DEL C.C.) / (IZQUIERDO)	96-98	8	5.9		11151	
RAM VAN 3500 (ANTES DEL C.C. / DESPUES DEL C.C.)	96-98	8	5.9		11161	
RAMCHARGER (ANTES DEL C.C.)	99-01	8	5.2		11994	
RAMCHARGER (ANTES DEL C.C.)	99-01	8	5.9		11994	
SHADOW (ANTES DEL C.C.) <b>S/C</b>	91-94	4	2.5		11022	
SHADOW (ANTES DEL C.C.)	91-94	4	2.5		11030	
SHADOW GTS (ANTES DEL C.C.) <b>S/C</b>	89-90	4	2.2		11022	
SHADOW GTS (ANTES DEL C.C.)	89-90	4	2.2		11030	
SPIRIT (ANTES DEL C.C.)	91-94	4	2.5		11030	
STRATUS (ANTES DEL C.C.)	06-06	4	2.0		11905	
STRATUS ÚNICO <b>S/C</b>	95-95	4	2.0		11022	
STRATUS (ANTES DEL C.C.) <b>S/C</b>	96-98	4	2.0		11022	
STRATUS (DESPUES DEL C.C.) <b>S/C</b>	96-98	4	2.0		11022	
STRATUS (ANTES DEL C.C.)	96-98	4	2.0		11030	
STRATUS (DESPUES DEL C.C.)	96-98	4	2.0		11158	
STRATUS (ANTES DEL C.C.) <b>S/C</b>	99-00	4	2.0		11022	
STRATUS (DESPUES DEL C.C.) <b>S/C</b>	99-00	4	2.0		11022	
STRATUS (ANTES DEL C.C.)	99-00	4	2.0		11144	
STRATUS (DESPUES DEL C.C.)	99-00	4	2.0		11161	
STRATUS (ANTES DEL C.C.) <b>S/C</b>	01-04	4	2.4		11022	

<b>CHRYSLER</b>		<b>DODGE</b>				
MODELO	AÑO	CIL.	MOTOR	SISTEMA	No. PARTE	
STRATUS (ANTES DEL C.C.)	01-04	4	2.4		11973	
STRATUS (ANTES DEL C.C.)	04-06	4	2.4		11905	
STRATUS (ANTES DEL C.C.)	96-98	4	2.4		11030	
STRATUS (DESPUES DEL C.C.)	96-98	4	2.4		11158	
STRATUS (DESPUES DEL C.C.) <b>S/C</b>	99-00	4	2.4		11022	
STRATUS (ANTES DEL C.C.)	99-00	4	2.4	MPFI	11144	
STRATUS (DESPUES DEL C.C.)	99-00	4	2.4		11161	
STRATUS UNICO ÚNICO	95-95	4	2.0		11030	
VERNA (ANTES DEL C.C.)	04-06	4	1.5		11958	
VERNA (ANTES DEL C.C.)	04-06	4	1.6		11958	
VIPER (DESPUES DEL C.C.)	03-06	10	8.3		11684	

<b>CHRYSLER</b>		<b>JEEP</b>				
MODELO	AÑO	CIL.	MOTOR	SISTEMA	No. PARTE	
CHEROKEE (DESPUES DEL C.C.)	14-15	4	2.4		11994	
CHEROKEE (ANTES DEL C.C.)	14-15	6	3.2		11994	
COMMANDER (ANTES DEL C.C.)	06-06	8	5.7		11961	
COMMANDER (ANTES DEL C.C.)	06-06	8	5.7		11994	
COMPASS (ANTES DEL C.C.) Y DESPUES DEL C.C.) <b>NUEVO</b>	07-10	4	2.4		11865	
COMPASS (ANTES DEL C.C.)	11-17	4	2.4		11901	
GRAND CHEROKEE (ANTES DEL C.C.)	11-15	6	3.6		11901	
GRAND CHEROKEE (DESPUES DEL C.C.)	11-15	6	3.6		11994	
GRAND CHEROKEE (ANTES DEL C.C.)	05-06	6	3.7		11961	
GRAND CHEROKEE (ANTES DEL C.C.) - BANCO 2	01-01	6	4.0		11144	
GRAND CHEROKEE (DESPUES DEL C.C.) - BANCO 1	01-03	6	4.0		11960	
GRAND CHEROKEE (ANTES DEL C.C.) - DERECHO	04-04	6	4.0		11961	
GRAND CHEROKEE (ANTES DEL C.C.) - BANCO 1	01-03	6	4.0		11962	
GRAND CHEROKEE (ANTES DEL C.C.) - BANCO 2	02-03	6	4.0		11962	
GRAND CHEROKEE (DESPUES DEL C.C.) - BANCO 2	01-03	6	4.0		11962	
GRAND CHEROKEE (DESPUES DEL C.C.)	04-04	6	4.0		11963	
GRAND CHEROKEE (DESPUES DEL C.C.)	99-00	8	4.7		11144	
GRAND CHEROKEE (ANTES DEL C.C.)	99-00	8	4.7		11151	
GRAND CHEROKEE (ANTES DEL C.C.) / (DESPUES DEL C.C.)	01-04	8	4.7		11960	
GRAND CHEROKEE (ANTES DEL C.C.)	93-95	8	5.2		11030	
GRAND CHEROKEE (DESPUES DEL C.C.)	96-98	8	5.2	MPFI	11144	
GRAND CHEROKEE (ANTES DEL C.C.)	96-98	8	5.2		11151	
GRAND CHEROKEE (ANTES DEL C.C.)	05-06	8	5.7		11961	
GRAND CHEROKEE (DESPUES DEL C.C.)	12-15	8	5.7		11994	
GRAND CHEROKEE (DESPUES DEL C.C.)	98-98	8	5.9		11144	
GRAND CHEROKEE (ANTES DEL C.C.)	98-98	8	5.9		11151	
GRAND CHEROKEE SRT-8 (ANTES DEL C.C.)	12-15	8	6.4		11901	
GRAND CHEROKEE SRT-8 (ANTES DEL C.C.)	06-06	8	6.1		11961	
GRAND CHEROKEE SRT-8 (DESPUES DEL C.C.)	14-15	8	6.4		11994	
LIBERTY (ANTES DEL C.C.) - DERECHO	02-04	6	3.7		11960	
LIBERTY (ANTES DEL C.C.) - IZQUIERDO	02-04	6	3.7		11961	
LIBERTY (ANTES DEL C.C.)	05-06	6	3.7		11961	
LIBERTY (DESPUES DEL C.C.) - DERECHO	02-04	6	3.7		11962	
LIBERTY (DESPUES DEL C.C.) - IZQUIERDO	02-04	6	3.7		11963	
PATRIOT (ANTES DEL C.C.) Y (DESPUES DEL C.C.) <b>NUEVO</b>	07-10	4	2.4		11865	
PATRIOT (ANTES DEL C.C.)	11-17	4	2.4		11901	
WRANGLER (ANTES DEL C.C.) / (DESPUES DEL C.C.)	05-06	4	2.4		11905	
WRANGLER (ANTES DEL C.C.)	93-93	4	2.5		11030	
WRANGLER (DESPUES DEL C.C.)	12-15	6	3.6		11994	
WRANGLER (ANTES DEL C.C.) <b>NUEVO</b>	07-10	6	3.8		11865	
WRANGLER (DESPUES DEL C.C.)	01-04	6	4.0		11684	
WRANGLER (DESPUES DEL C.C.) - DERECHO	05-06	6	4.0		11961	

<b>FIAT</b>						
MODELO	AÑO	CIL.	MOTOR	SISTEMA	No. PARTE	
PALIO (ANTES DEL C.C.)	04-06	4	1.6	MPFI	11956	
UNO (ANTES DEL C.C.)	13-13	4	1.4		11956	

<b>FORD</b>						
MODELO	AÑO	CIL.	MOTOR	SISTEMA	No. PARTE	
AEROSTAR (DESPUES DEL C.C.)	92-93	6	3.0	MPFI	11021	
AEROSTAR (DESPUES DEL C.C.) <b>S/C</b>	92-93	6	3.0		11022	

CONTINÚA»



**A/F (AIR FUEL RATIO SENSOR)**

**S/C (SIN CONECTOR)**

**5 CAB. (5 CABLES)**

<b>FORD</b>					
MODELO	AÑO	CIL.	MOTOR	SISTEMA	No. PARTE
AEROSTAR (DESPUÉS DEL C.C.)	92-94	6	4.0		11047
CONTOUR (ANTES DEL C.C.) S/C	96-98	4	2.0		11022
CONTOUR (DESPUÉS DEL C.C.) S/C	96-98	4	2.0		11022
CONTOUR (ANTES DEL C.C.)	96-98	4	2.0		11091
CONTOUR (DESPUÉS DEL C.C.)	96-98	4	2.0		11224
CONTOUR (ANTES DEL C.C.) S/C	95-98	6	2.5		11022
CONTOUR (ANTES DEL C.C.) S/C	99-00	6	2.5		11022
CONTOUR (DESPUÉS DEL C.C.) S/C	96-00	6	2.5		11022
CONTOUR (ANTES DEL C.C.)	95-98	6	2.5		11091
CONTOUR (ANTES DEL C.C.)	99-00	6	2.5		11210
CONTOUR (DESPUÉS DEL C.C.)	96-00	6	2.5		11224
COURIER (ANTES DEL C.C.) S/C	01-12	4	1.6		11022
COURIER (ANTES DEL C.C.)	01-03	4	1.6		11089
COURIER (ANTES DEL C.C.)	04-12	4	1.6		11900
ECONOLINE E-150 (ANTES DEL C.C.) S/C	97-00	6	4.2		11022
ECONOLINE E-150 (ANTES DEL C.C.)	97-00	6	4.2		11023
ECONOLINE E-150 (ANTES DEL C.C.) 5 CAB.	09-14	8	4.6		11904
ECONOLINE E-250 (DESPUÉS DEL C.C.) S/C	97-99	6	4.2		11022
ECONOLINE E-250 (DESPUÉS DEL C.C.)	97-99	6	4.2		11023
ECOSPORT (ANTES DEL C.C.) S/C	04-05	4	2.0		11022
ECOSPORT (ANTES DEL C.C.)	04-05	4	2.0		11089
EDGE (ANTES DEL C.C.) BANDA ANCHA <b>NUEVO</b>	11-14	6	3.5		11872
EDGE (DESPUÉS DEL C.C.)	11-14	6	3.5		11884
EDGE (ANTES DEL C.C.) 5 CAB.	10-10	6	3.5		11904
ESCAPE (DESPUÉS DEL C.C.) <b>NUEVO</b>	14-16	4	2.0		11870
ESCAPE (ANTES DEL C.C.) 5 CAB.	14-15	4	2.0		11904
ESCAPE (ANTES DEL C.C.)	05-08	4	2.3		11210
ESCAPE (DESPUÉS DEL C.C.)	05-08	4	2.3		11222
ESCAPE (DESPUÉS DEL C.C.)	11-12	4	2.5		11670
ESCAPE (DESPUÉS DEL C.C.)	13-17	4	2.5		11682
ESCAPE (ANTES DEL C.C.)	11-12	4	2.5		11885
ESCAPE ANTES DEL C.C. - FRONTAL S/C	01-10	6	3.0		11022
ESCAPE (ANTES DEL C.C.) - TRASERO S/C	01-10	6	3.0		11022
ESCAPE (DESPUÉS DEL C.C.) - TRASERO S/C	01-10	6	3.0	MPFI	11022
ESCAPE (DESPUÉS DEL C.C.) - FRONTAL S/C	01-10	6	3.0		11022
ESCAPE (ANTES DEL C.C.) - FRONTAL	01-10	6	3.0		11210
ESCAPE (ANTES DEL C.C.) - TRASERO	01-10	6	3.0		11222
ESCAPE (DESPUÉS DEL C.C.) - TRASERO	01-10	6	3.0		11224
ESCAPE (DESPUÉS DEL C.C.)	11-12	6	3.0		11670
ESCAPE (ANTES DEL C.C.) BANDA ANCHA / 5 CAB. <b>NUEVO</b>	10-12	6	3.0		11872
ESCAPE (DESPUÉS DEL C.C.) - FRONTAL	01-10	6	3.0		11986
ESCAPE TA (ANTES DEL C.C.) BANDA ANCHA / 5 CAB. <b>NUEVO</b>	10-13	4	2.5		11872
ESCORT (ANTES DEL C.C.) S/C	95-95	4	1.9		11022
ESCORT (ANTES DEL C.C.)	95-95	4	1.9		11047
ESCORT (ANTES DEL C.C.)	98-99	4	2.0		11021
ESCORT (ANTES DEL C.C.) S/C	97-99	4	2.0		11022
ESCORT (ANTES DEL C.C.) S/C	00-01	4	2.0		11022
ESCORT (DESPUÉS DEL C.C.) S/C	98-99	4	2.0		11022
ESCORT (DESPUÉS DEL C.C.) S/C	00-01	4	2.0		11022
ESCORT (DESPUÉS DEL C.C.) S/C	00-01	4	2.0		11022
ESCORT (DESPUÉS DEL C.C.) S/C	97-99	4	2.0		11022
ESCORT (DESPUÉS DEL C.C.)	98-99	4	2.0		11047
ESCORT (ANTES DEL C.C.)	97-99	4	2.0		11097
ESCORT (DESPUÉS DEL C.C.)	00-01	4	2.0		11217
ESCORT (DESPUÉS DEL C.C.)	97-99	4	2.0		11221
ESCORT (DESPUÉS DEL C.C.)	00-01	4	2.0		11221
ESCORT (ANTES DEL C.C.)	00-01	4	2.0		11995
ESCORT (ANTES DEL C.C.)	00-01	4	2.0		11995
EXPEDITION (ANTES DEL C.C.) S/C	97-07	8	5.4		11022
EXPEDITION (DESPUÉS DEL C.C.) S/C	97-07	8	5.4		11022
EXPEDITION (ANTES DEL C.C.)	97-07	8	5.4		11139
EXPEDITION (DESPUÉS DEL C.C.)	97-07	8	5.4		11210
EXPEDITION (DESPUÉS DEL C.C.)	12-14	8	5.4		11673
EXPEDITION (ANTES DEL C.C.) 5 CAB.	09-14	8	5.4		11904
EXPLORER (DESPUÉS DEL C.C.)	13-15	6	3.5		11670
EXPLORER (ANTES DEL C.C.) BANDA ANCHA / 5 CAB. <b>NUEVO</b>	14-15	6	3.5		11872

<b>FORD</b>					
MODELO	AÑO	CIL.	MOTOR	SISTEMA	No. PARTE
EXPLORER (DESPUÉS DEL C.C.)	15-17	6	3.5		11884
EXPLORER (DESPUÉS DEL C.C.) S/C	97-99	6	4.0		11022
EXPLORER (DESPUÉS DEL C.C.) S/C	00-07	6	4.0		11022
EXPLORER (ANTES DEL C.C.) S/C	97-99	6	4.0		11022
EXPLORER (DESPUÉS DEL C.C.)	91-94	6	4.0		11047
EXPLORER (ANTES DEL C.C.)	97-99	6	4.0		11139
EXPLORER (DESPUÉS DEL C.C.)	00-07	6	4.0		11139
EXPLORER (ANTES DEL C.C.)	00-07	6	4.0		11210
EXPLORER (DESPUÉS DEL C.C.)	97-99	6	4.0		11217
F-150 (DESPUÉS DEL C.C.)	10-14	6	3.7		11670
F-150 (ANTES DEL C.C.) BANDA ANCHA / 5 CAB. <b>NUEVO</b>	11-14	6	3.7		11872
F-150 (ANTES DEL C.C.)	92-93	6	3.8		11021
F-150 (ANTES DEL C.C.) S/C	92-93	6	3.8		11022
F-150 (ANTES DEL C.C.) / (DESPUÉS DEL C.C.) S/C	97-07	6	4.2		11022
F-150 (ANTES DEL C.C.) / (DESPUÉS DEL C.C.)	97-07	6	4.2		11210
F-150 (ANTES DEL C.C.)	10-10	8	4.6		11023
F-150 (ANTES DEL C.C.)	97-98	8	4.6		11139
F-150 (ANTES DEL C.C.) 5 CAB.	09-10	8	4.6		11904
F-150 (ANTES DEL C.C.) S/C	96-97	6	4.9		11022
F-150 (ANTES DEL C.C.)	96-97	6	4.9		11139
F-150 (DESPUÉS DEL C.C.)	11-14	8	5.0		11666
F-250 (ANTES DEL C.C.)	92-95	8	5.0		11021
F-250 (ANTES DEL C.C.) S/C	96-97	8	5.0		11022
F-250 (ANTES DEL C.C.)	96-97	8	5.0		11139
F-250 (DESPUÉS DEL C.C.)	92-94	8	5.8		11047
F-250 (ANTES DEL C.C.)	96-97	8	5.8		11139
F-350 (ANTES DEL C.C.)	92-95	8	5.0		11021
F-350 (ANTES DEL C.C.) S/C	96-98	8	5.0		11022
F-350 (ANTES DEL C.C.)	96-98	8	5.0		11139
F-350 (DESPUÉS DEL C.C.)	92-94	8	5.8		11047
F-350 (ANTES DEL C.C.)	95-98	8	5.8		11139
F-350 SUPER DUTY (DESPUÉS DEL C.C.) S/C	00-07	8	5.4		11022
F-350 SUPER DUTY (ANTES DEL C.C.) / (DESPUÉS DEL C.C.) S/C	98-07	8	5.4	MPFI	11022
F-350 SUPER DUTY (DESPUÉS DEL C.C.)	00-07	8	5.4		11209
F-350 SUPER DUTY (ANTES DEL C.C.)	98-07	8	5.4		11210
F-350 SUPER DUTY (DESPUÉS DEL C.C.)	12-15	8	6.2		11673
F-350 SUPER DUTY (ANTES DEL C.C.) 5 CAB.	11-13	8	6.2		11904
F-450 SUPER DUTY (DESPUÉS DEL C.C.) S/C	00-05	10	6.8		11022
F-450 SUPER DUTY (ANTES DEL C.C.) S/C	00-05	10	6.8		11022
F-450 SUPER DUTY (DESPUÉS DEL C.C.)	00-05	10	6.8		11209
F-450 SUPER DUTY (ANTES DEL C.C.)	00-05	10	6.8		11210
F-450 SUPER DUTY (DESPUÉS DEL C.C.)	13-13	10	6.8		11673
F-550 SUPER DUTY (DESPUÉS DEL C.C.)	13-13	10	6.8		11673
F-550 SUPER DUTY (ANTES DEL C.C.) 5 CAB.	11-14	10	6.8		11904
FIESTA (ANTES DEL C.C.) S/C	98-01	4	1.3		11022
FIESTA (ANTES DEL C.C.)	98-01	4	1.3		11986
FIESTA (ANTES DEL C.C.) S/C	98-00	4	1.4		11022
FIESTA (ANTES DEL C.C.)	98-00	4	1.4		11986
FIESTA (ANTES DEL C.C.)	11-13	4	1.6		11210
FIESTA (DESPUÉS DEL C.C.)	14-17	4	1.6		11220
FIESTA (DESPUÉS DEL C.C.)	11-13	4	1.6		11224
FIESTA (ANTES DEL C.C.)	03-07	4	1.6		11900
FIESTA (ANTES DEL C.C.) A/F 5 CAB.	14-17	4	1.6		11913
FIVE HUNDRED (DESPUÉS DEL C.C.) S/C	05-07	6	3.0		11022
FIVE HUNDRED (ANTES DEL C.C.) S/C	05-07	6	3.0		11022
FIVE HUNDRED (DESPUÉS DEL C.C.)	05-07	6	3.0		11224
FIVE HUNDRED (ANTES DEL C.C.) - TRASERO	05-07	6	3.0		11995
FOCUS (DESPUÉS DEL C.C.)	00-02	4	2.0		11021
FOCUS (ANTES DEL C.C.) / (DESPUÉS DEL C.C.) S/C	00-05	4	2.0		11022
FOCUS (DESPUÉS DEL C.C.)	03-05	4	2.0		11220
FOCUS (ANTES DEL C.C.)	05-06	4	2.0		11650
FOCUS (DESPUÉS DEL C.C.)	05-07	4	2.0		11662
FOCUS (DESPUÉS DEL C.C.)	09-11	4	2.0		11667
FOCUS (ANTES DEL C.C.)	06-11	4	2.0		11675
FOCUS (DESPUÉS DEL C.C.) <b>NUEVO</b>	12-17	4	2.0		11870
FOCUS (ANTES DEL C.C.) 5 CAB.	12-15	4	2.0		11904

# SENSORES DE OXÍGENO

**A/F** (AIR FUEL RATIO SENSOR)

**S/C** (SIN CONECTOR)

**5 CAB.** (5 CABLES)

FORD					
MODELO	AÑO	CIL.	MOTOR	SISTEMA	No. PARTE
FOCUS (ANTES DEL C.C.)	00-05	4	2.0		11995
FOCUS EN C.C. (DESPUÉS DEL C.C.) - EN CATALIZADOR	05-08	4	2.0		11667
FOCUS STATION WAGON (ANTES DEL C.C.) <b>S/C</b>	00-05	4	2.0		11022
FOCUS STATION WAGON (ANTES DEL C.C.)	00-05	4	2.0		11995
FOCUS TURBO (DESPUÉS DEL C.C.) <b>NUEVO</b>	13-17	4	2.0		11870
FOCUS ZX3 (ANTES DEL C.C.) <b>S/C</b>	00-04	4	2.0		11022
FOCUS ZX3 (ANTES DEL C.C.)	00-04	4	2.0		11995
FREESTAR (ANTES DEL C.C.) / (DESPUÉS DEL C.C.) <b>S/C</b>	04-07	6	4.2		11022
FREESTAR (ANTES DEL C.C.) / (DESPUÉS DEL C.C.)	04-07	6	4.2		11222
FUSION (ANTES DEL C.C.) / (DESPUÉS DEL C.C.) <b>S/C</b>	06-07	4	2.3		11022
FUSION (ANTES DEL C.C.)	06-07	4	2.3		11098
FUSION (DESPUÉS DEL C.C.)	06-07	4	2.3		11217
FUSION (DESPUÉS DEL C.C.)	11-12	4	2.5		11670
FUSION (DESPUÉS DEL C.C.)	13-17	4	2.5		11682
FUSION (ANTES DEL C.C.) BANDA ANCHA / <b>5 CAB. NUEVO</b>	13-13	4	2.5		11860
FUSION (DESPUÉS DEL C.C.) - FRONTAL	11-12	6	3.0		11670
FUSION (ANTES DEL C.C.) BANDA ANCHA / <b>5 CAB. NUEVO</b>	10-12	6	3.0		11872
FUSION (DESPUÉS DEL C.C.)	11-12	6	3.0		11884
FUSION HIBRIDO (DESPUÉS DEL C.C.)	17-17	4	2.0		11682
FUSION SPORT (ANTES DEL C.C.) BANDA ANCHA / <b>5 CAB. NUEVO</b>	10-10	6	3.5		11872
FUSION SPORT (DESPUÉS DEL C.C.)	11-12	6	3.5		11884
FUSION SPORT (ANTES DEL C.C.)	11-12	6	3.5		11885
FUSION TA (ANTES DEL C.C.) BANDA ANCHA / <b>5 CAB. NUEVO</b>	10-12	4	2.5		11872
FUSION TURBO (DESPUÉS DEL C.C.) <b>NUEVO</b>	14-16	4	2.0		11870
FUSION TURBO (ANTES DEL C.C.) <b>5 CAB.</b>	13-16	4	2.0		11904
GHIA (ANTES DEL C.C.) <b>S/C</b>	91-91	4	2.3		11022
GHIA (ANTES DEL C.C.)	91-91	4	2.3		11023
GHIA (ANTES DEL C.C.)	93-94	6	3.0		11021
GHIA (ANTES DEL C.C.) <b>S/C</b>	93-94	6	3.0		11022
IKON (ANTES DEL C.C.) <b>S/C</b>	01-03	4	1.6		11022
IKON (ANTES DEL C.C.)	01-03	4	1.6		11089
KA (ANTES DEL C.C.) <b>S/C</b>	01-08	4	1.6		11022
KA (ANTES DEL C.C.)	01-08	4	1.6		11089
MUSTANG (DESPUÉS DEL C.C.)	11-14	6	3.7	MPFI	11670
MUSTANG (ANTES DEL C.C.) BANDA ANCHA / <b>5 CAB. NUEVO</b>	11-14	6	3.7		11872
MUSTANG (ANTES DEL C.C.) <b>S/C</b>	05-10	6	4.0		11022
MUSTANG (DESPUÉS DEL C.C.) <b>S/C</b>	05-07	6	4.0		11022
MUSTANG (ANTES DEL C.C.)	05-10	6	4.0		11220
MUSTANG (DESPUÉS DEL C.C.)	05-07	6	4.0		11222
MUSTANG (ANTES DEL C.C.) <b>S/C</b>	96-07	8	4.6		11022
MUSTANG (DESPUÉS DEL C.C.) <b>S/C</b>	96-10	8	4.6		11022
MUSTANG (ANTES DEL C.C.)	96-10	8	4.6		11220
MUSTANG (DESPUÉS DEL C.C.)	96-10	8	4.6		11222
MUSTANG (DESPUÉS DEL C.C.) <b>S/C</b>	94-95	8	5.0		11022
MUSTANG (DESPUÉS DEL C.C.)	94-95	8	5.0		11210
MUSTANG (DESPUÉS DEL C.C.)	11-14	8	5.0		11670
MUSTANG (ANTES DEL C.C.) <b>5 CAB.</b>	11-14	8	5.0		11904
MUSTANG SHELBY GT (DESPUÉS DEL C.C.)	11-12	8	5.4		11670
MUSTANG SHELBY GT (ANTES DEL C.C.) <b>5 CAB.</b>	11-12	8	5.4		11904
RANGER (ANTES DEL C.C.) / (DESPUÉS DEL C.C.) <b>S/C</b>	01-07	4	2.3		11022
RANGER (ANTES DEL C.C.) / (DESPUÉS DEL C.C.)	01-07	4	2.3		11139
RANGER (ANTES DEL C.C.)	10-13	4	2.3		11220
RANGER (DESPUÉS DEL C.C.)	11-13	4	2.3		11986
RANGER (ANTES DEL C.C.) / (DESPUÉS DEL C.C.) <b>S/C</b>	98-02	6	3.0		11022
RANGER (DESPUÉS DEL C.C.)	98-02	6	3.0		11047
RANGER (ANTES DEL C.C.)	98-02	6	3.0		11210
TAURUS (DESPUÉS DEL C.C.)	91-91	6	3.8		11021
TAURUS (ANTES DEL C.C.) <b>S/C</b>	91-91	6	3.8		11022
TAURUS (ANTES DEL C.C.)	91-91	6	3.8		11023
THUNDERBIRD (DESPUÉS DEL C.C.)	91-94	6	3.8		11021
THUNDERBIRD (DESPUÉS DEL C.C.)	94-94	6	3.8		11098
THUNDERBIRD (ANTES DEL C.C.)	95-95	8	4.6		11021
THUNDERBIRD (ANTES DEL C.C.) <b>S/C</b>	95-95	8	4.6		11022
THUNDERBIRD (DESPUÉS DEL C.C.) <b>S/C</b>	95-95	8	4.6		11022
THUNDERBIRD (DESPUÉS DEL C.C.)	95-95	8	4.6		11209
THUNDERBIRD (ANTES DEL C.C.)	91-93	8	5.0		11021

FORD					
MODELO	AÑO	CIL.	MOTOR	SISTEMA	No. PARTE
THUNDERBIRD (ANTES DEL C.C.) <b>S/C</b>	91-93	8	5.0		11022
THUNDERBIRD SC (DESPUÉS DEL C.C.)	91-93	6	3.8		11021
THUNDERBIRD SC (DESPUÉS DEL C.C.)	94-94	6	3.8		11097
WINDSTAR (ANTES DEL C.C.) <b>S/C</b>	95-03	6	3.8	MPFI	11022
WINDSTAR (DESPUÉS DEL C.C.) <b>S/C</b>	95-03	6	3.8		11022
WINDSTAR (ANTES DEL C.C.)	95-03	6	3.8		11139
WINDSTAR (DESPUÉS DEL C.C.)	95-03	6	3.8		11209

FORD						LINCOLN					
MODELO	AÑO	CIL.	MOTOR	SISTEMA	No. PARTE	MODELO	AÑO	CIL.	MOTOR	SISTEMA	No. PARTE
MKS (DESPUÉS DEL C.C.)	13-14	6	3.7		11670						
MKS (ANTES DEL C.C.) BANDA ANCHA / <b>5 CAB. NUEVO</b>	13-16	6	3.7		11872						
MKS (DESPUÉS DEL C.C.)	11-12	6	3.7		11884						
MKS (ANTES DEL C.C.) <b>5 CAB.</b>	09-12	6	3.7		11904						
MKS TURBO (ANTES DEL C.C.) <b>5 CAB.</b>	11-11	6	3.5		11904						
MKX (ANTES DEL C.C.) <b>5 CAB.</b>	10-10	6	3.5		11904						
MKX (ANTES DEL C.C.) BANDA ANCHA / <b>5 CAB. NUEVO</b>	11-15	6	3.7		11872						
MKX (DESPUÉS DEL C.C.)	11-15	6	3.7		11884						
MKX (ANTES DEL C.C.) <b>5 CAB.</b>	11-11	6	3.7		11904						
MKZ (ANTES DEL C.C.) <b>5 CAB.</b>	13-16	4	2.0		11904						
MKZ (DESPUÉS DEL C.C.)	11-12	6	3.5		11884						
MKZ (ANTES DEL C.C.)	11-12	6	3.5		11885						
MKZ (DESPUÉS DEL C.C.)	13-16	6	3.7		11670						
MKZ TURBO (DESPUÉS DEL C.C.) <b>NUEVO</b>	13-14	4	2.0		11870						
NAVIGATOR (DESPUÉS DEL C.C.)	12-14	8	5.4		11673						
NAVIGATOR (ANTES DEL C.C.) <b>5 CAB.</b>	09-14	8	5.4		11904						

FORD						MERCURY					
MODELO	AÑO	CIL.	MOTOR	SISTEMA	No. PARTE	MODELO	AÑO	CIL.	MOTOR	SISTEMA	No. PARTE
COUGAR XR7 (DESPUÉS DEL C.C.)	91-94	6	3.8		11021						
COUGAR XR7 (DESPUÉS DEL C.C.) <b>S/C</b>	91-94	6	3.8		11022						
COUGAR XR7 (DESPUÉS DEL C.C.)	91-94	6	3.8		11047						
GRAND MARQUIS (ANTES DEL C.C.)	92-94	8	4.6		11021						
GRAND MARQUIS (ANTES DEL C.C.) <b>S/C</b>	92-94	8	4.6		11022						
GRAND MARQUIS (ANTES DEL C.C.) <b>S/C</b>	95-04	8	4.6		11022						
GRAND MARQUIS (DESPUÉS DEL C.C.) <b>S/C</b>	96-04	8	4.6		11022						
GRAND MARQUIS (DESPUÉS DEL C.C.)	92-93	8	4.6		11047						
GRAND MARQUIS (DESPUÉS DEL C.C.)	95-04	8	4.6		11098						
GRAND MARQUIS (DESPUÉS DEL C.C.) <b>S/C</b>	80-85	8	5.0		11022						
MARINER (ANTES DEL C.C.) <b>S/C</b>	05-07	6	3.0		11022						
MARINER (DESPUÉS DEL C.C.) <b>S/C</b>	05-07	6	3.0		11022						
MARINER (ANTES DEL C.C.)	05-08	6	3.0		11210						
MARINER (ANTES DEL C.C.) BANDA ANCHA / <b>5 CAB. NUEVO</b>	10-11	6	3.0		11872						
MARINER (DESPUÉS DEL C.C.)	05-07	6	3.0		11986						
MONTEGO (DESPUÉS DEL C.C.) <b>S/C</b>	05-07	6	3.0		11022						
MONTEGO (ANTES DEL C.C.) <b>S/C</b>	05-07	6	3.0		11022						
MONTEGO (DESPUÉS DEL C.C.)	05-07	6	3.0		11986						
MONTEGO (ANTES DEL C.C.)	05-07	6	3.0		11995						
MYSTIQUE (ANTES DEL C.C.) <b>S/C</b>	96-98	4	2.0		11022						
MYSTIQUE (DESPUÉS DEL C.C.) <b>S/C</b>	96-98	4	2.0		11022						
MYSTIQUE (ANTES DEL C.C.) <b>S/C</b>	00-00	4	2.0		11022						
MYSTIQUE (ANTES DEL C.C.) <b>S/C</b>	00-00	4	2.0		11022						
MYSTIQUE (ANTES DEL C.C.)	96-98	4	2.0		11091						
MYSTIQUE (DESPUÉS DEL C.C.)	96-98	4	2.0		11224						
MYSTIQUE (ANTES DEL C.C.)	00-00	4	2.0		11995						
MYSTIQUE (ANTES DEL C.C.) <b>S/C</b>	95-98	6	2.5		11022						
MYSTIQUE (DESPUÉS DEL C.C.) <b>S/C</b>	96-00	6	2.5		11022						
MYSTIQUE (ANTES DEL C.C.)	95-98	6	2.5		11091						
MYSTIQUE (DESPUÉS DEL C.C.)	96-00	6	2.5		11224						
SABLE (DESPUÉS DEL C.C.)	94-95	6	3.0		11021						
SABLE (DESPUÉS DEL C.C.)	96-04	6	3.0		11098						
SABLE (ANTES DEL C.C.)	96-04	6	3.0		11224						
SABLE (ANTES DEL C.C.) <b>S/C</b>	94-95	6	3.8		11022						
SABLE (ANTES DEL C.C.)	94-95	6	3.8		11023						

CONTINUA

**A/F (AIR FUEL RATIO SENSOR)**

**S/C (SIN CONECTOR)**

**5 CAB. (5 CABLES)**

FORD		MERCURY			
MODELO	AÑO	CIL.	MOTOR	SISTEMA	No. PARTE
SABLE (DESPUÉS DEL C.C.)	94-94	6	3.8		11098
TOPAZ (ANTES DEL C.C.) <b>S/C</b>	91-94	4	2.3	MPFI	11022
TOPAZ (ANTES DEL C.C.)	91-94	4	2.3		11023

GENERAL MOTORS		BUICK			
MODELO	AÑO	CIL.	MOTOR	SISTEMA	No. PARTE
CENTURY (ANTES DEL C.C.)	91-95	6	3.1		11001
ENCLAVE (ANTES DEL C.C.) Y (DESPUÉS DEL C.C.) <b>NUEVO</b>	10-11	6	3.6		11871
LACROSSE (ANTES DEL C.C.) Y (DESPUÉS DEL C.C.) <b>NUEVO</b>	10-16	6	3.6		11871
REGAL (ANTES DEL C.C.) / (DESPUÉS DEL C.C.)	13-13	4	2.0	MPFI	11879
VERANO (ANTES DEL C.C.)	14-16	4	2.4		11879
VERANO TURBO (ANTES DEL C.C.)	13-16	4	2.0		11879

GENERAL MOTORS		CADILLAC			
MODELO	AÑO	CIL.	MOTOR	SISTEMA	No. PARTE
CTS (DESPUÉS DEL C.C.) <b>NUEVO</b>	04-04	6	3.6		11871
CTS (DESPUÉS DEL C.C.) <b>NUEVO</b>	12-15	8	6.2		11866
DEVILLE (ANTES DEL C.C.)	92-94	8	4.9		11000
DEVILLE (ANTES DEL C.C.) <b>S/C</b>	92-94	8	4.9		11012
ESCALADE (ANTES DEL C.C.) / (DESPUÉS DEL C.C.)	03-05	8	5.3		11280
ESCALADE (ANTES DEL C.C.)	02-02	8	5.3		11636
ESCALADE (ANTES DEL C.C.)	03-06	8	6.0		11283
ESCALADE (DESPUÉS DEL C.C.)	03-06	8	6.0		11625
ESCALADE (ANTES DEL C.C.)	08-11	8	6.0	MPFI	11894
ESCALADE ESV (ANTES DEL C.C.)	03-06	8	6.2		11283
ESCALADE EXT (ANTES DEL C.C.)	03-06	8	6.0		11283
SRX (ANTES DEL C.C.) Y (DESPUÉS DEL C.C.) <b>NUEVO</b>	10-11	6	3.0		11871
SRX (ANTES DEL C.C.) / (DESPUÉS DEL C.C.)	12-16	6	3.6		11283
SRX (ANTES DEL C.C.) Y (DESPUÉS DEL C.C.) <b>NUEVO</b>	12-16	6	3.6		11871
SRX (DESPUÉS DEL C.C.) <b>NUEVO</b>	04-04	6	3.6		11871
SRX (DESPUÉS DEL C.C.) <b>NUEVO</b>	04-04	8	4.6		11871
XLR (DESPUÉS DEL C.C.) <b>NUEVO</b>	04-05	8	4.6		11871

GENERAL MOTORS		CHEVROLET			
MODELO	AÑO	CIL.	MOTOR	SISTEMA	No. PARTE
ASTRA (ANTES DEL C.C.) / (DESPUÉS DEL C.C.)	00-03	4	1.8		11971
ASTRA (DESPUÉS DEL C.C.)	04-06	4	2.0		11965
ASTRA (DESPUÉS DEL C.C.)	01-03	4	2.2		11966
ASTRA (ANTES DEL C.C.) / (DESPUÉS DEL C.C.)	01-03	4	2.2		11967
ASTRA (ANTES DEL C.C.)	04-06	4	2.4		11066
ASTRA (DESPUÉS DEL C.C.)	04-06	4	2.4		11965
AVALANCHE (ANTES DEL C.C.) / (DESPUÉS DEL C.C.)	02-05	8	5.3		11280
AVALANCHE (ANTES DEL C.C.)	08-11	8	5.3	MPFI	11894
AVEO (ANTES DEL C.C.)	08-17	4	1.6		11964
AVEO (DESPUÉS DEL C.C.)	08-17	4	1.6		11996
BEAT (DESPUÉS DEL C.C.)	18-18	4	1.2		11964
BEAT (ANTES DEL C.C.)	18-18	4	1.2		11996
BLAZER (ANTES DEL C.C.) / (DESPUÉS DEL C.C.)	95-01	6	4.3		11066
BLAZER (ANTES DEL C.C.) / (DESPUÉS DEL C.C.)	01-02	6	4.3		11280
BLAZER (ANTES DEL C.C.) / (DESPUÉS DEL C.C.) <b>S/C</b>	95-01	6	4.3		11979
BLAZER NEVADA (ANTES DEL C.C.)	91-94	6	3.1	TBI	11001
BLAZER NEVADA (ANTES DEL C.C.) <b>S/C</b>	91-94	6	3.1		11011
C2500 (ANTES DEL C.C.)	96-98	8	5.0	MPFI	11173
C2500 (ANTES DEL C.C.)	94-98	8	5.7	TBI	11001
C2500 (ANTES DEL C.C.)	96-00	8	5.7		11173
C2500 (ANTES DEL C.C.) / IZQUIERDO Y DERECHO	96-98	8	5.7	MPFI	11646
C3500 (ANTES DEL C.C.)	94-98	8	5.7	TBI	11001
C3500 (ANTES DEL C.C.) / IZQUIERDO Y DERECHO	96-00	8	5.7		11646
CAMARO (ANTES DEL C.C.)	95-98	8	5.7		11066
CAMARO (ANTES DEL C.C.) / (DESPUÉS DEL C.C.)	99-02	8	5.7		11281
CAMARO (ANTES DEL C.C.) <b>S/C</b>	95-98	8	5.7	MPFI	11979
CAPTIVA SPORT (ANTES DEL C.C.) Y (DESPUÉS DEL C.C.) <b>NUEVO</b>	12-12	6	3.0		11871
CAPTIVA SPORT (ANTES DEL C.C.)	08-10	6	3.6		11280
CAVALIER (ANTES DEL C.C.)	95-98	4	2.2		11001

GENERAL MOTORS		CHEVROLET			
MODELO	AÑO	CIL.	MOTOR	SISTEMA	No. PARTE
CAVALIER (ANTES DEL C.C.) <b>S/C</b>	95-98	4	2.2		11011
CAVALIER (ANTES DEL C.C.)	02-04	4	2.2		11172
CAVALIER (ANTES DEL C.C.)	99-99	4	2.2		11282
CAVALIER (ANTES DEL C.C.)	00-01	4	2.2		11627
CAVALIER (ANTES DEL C.C.)	91-94	6	2.8	MPFI	11001
CAVALIER (ANTES DEL C.C.) <b>S/C</b>	91-94	6	2.8		11011
CAVALIER Z24 (ANTES DEL C.C.)	91-94	6	3.1		11001
CAVALIER Z24 (ANTES DEL C.C.) <b>S/C</b>	91-94	6	3.1		11011
CHEVY (ANTES DEL C.C.)	94-95	4	1.4		11001
CHEVY (ANTES DEL C.C.)	96-03	4	1.4	TBI	11001
CHEVY (ANTES DEL C.C.) <b>S/C</b>	94-95	4	1.4	MPFI	11011
CHEVY (ANTES DEL C.C.) <b>S/C</b>	96-03	4	1.4	TBI	11011
CHEVY (ANTES DEL C.C.)	96-03	4	1.6	MPFI	11001
CHEVY (ANTES DEL C.C.)	96-03	4	1.6	TBI	11001
CHEVY (ANTES DEL C.C.) <b>S/C</b>	96-03	4	1.6	MPFI	11011
CHEVY (ANTES DEL C.C.) <b>S/C</b>	96-03	4	1.6	TBI	11011
CHEVY (ANTES DEL C.C.) / (DESPUÉS DEL C.C.)	09-12	4	1.6		11170
CHEVY C2 (ANTES DEL C.C.) / (DESPUÉS DEL C.C.)	04-08	4	1.6	MPFI	11625
CHEVY MONZA (ANTES DEL C.C.)	96-03	4	1.6		11001
CHEVY MONZA (ANTES DEL C.C.)	96-03	4	1.6	TBI	11001
CHEVY MONZA (ANTES DEL C.C.) <b>S/C</b>	96-03	4	1.6	MPFI	11011
CHEVY MONZA (ANTES DEL C.C.) <b>S/C</b>	96-03	4	1.6	TBI	11011
CHEVY PICK UP (ANTES DEL C.C.)	99-03	4	1.6		11001
CHEVY PICK UP (ANTES DEL C.C.) <b>S/C</b>	99-03	4	1.6	MPFI	11011
CHEVY WAGON (ANTES DEL C.C.)	00-03	4	1.6		11001
CHEVY WAGON (ANTES DEL C.C.) <b>S/C</b>	00-03	4	1.6		11011
CHEYENNE CUSTOM (ANTES DEL C.C.) <b>S/C</b>	93-99	8	5.7	TBI	11011
COLORADO (ANTES DEL C.C.) Y (DESPUÉS DEL C.C.) <b>NUEVO</b>	15-15	6	3.6		11871
CORSA (ANTES DEL C.C.)	02-02	4	1.4		11971
CORSA (ANTES DEL C.C.)	03-05	4	1.8		11001
CORSA (ANTES DEL C.C.) <b>S/C</b>	03-05	4	1.8		11011
CORSA (ANTES DEL C.C.)	06-06	4	1.8		11066
CORSA (ANTES DEL C.C.) <b>A/F</b>	07-08	4	1.8		11898
CORVETTE (ANTES DEL C.C.)	93-04	8	5.7		11066
CORVETTE (ANTES DEL C.C.) <b>S/C</b>	93-04	8	5.7		11979
CORVETTE (ANTES DEL C.C.) - DERECHO / IZQUIERDO	05-07	8	6.0		11879
CORVETTE (ANTES DEL C.C.) - DERECHO / IZQUIERDO	08-13	8	6.2		11879
CRUZE (DESPUÉS DEL C.C.)	10-15	4	1.8		11903
CRUZE (ANTES DEL C.C.)	10-15	4	1.8		11971
EQUINOX (ANTES DEL C.C.)	05-08	6	3.4		11280
EQUINOX (DESPUÉS DEL C.C.)	05-08	6	3.4		11281
EXPRESS 1500 (ANTES DEL C.C.) / (DESPUÉS DEL C.C.)	00-02	6	4.3		11066
EXPRESS 1500 (ANTES DEL C.C.) - DERECHO	03-06	6	4.3		11170
EXPRESS 1500 (DESPUÉS DEL C.C.)	00-02	6	4.3		11173
EXPRESS 1500 (ANTES DEL C.C.)	96-02	6	4.3		11173
EXPRESS 1500 (ANTES DEL C.C.) / (DESPUÉS DEL C.C.) - IZQUIERDO	03-06	6	4.3		11625
EXPRESS 1500 (ANTES DEL C.C.) / (DESPUÉS DEL C.C.) <b>S/C</b>	00-02	6	4.3	MPFI	11979
EXPRESS 1500 (ANTES DEL C.C.) / (DESPUÉS DEL C.C.) - DERECHO	03-07	8	5.3		11170
EXPRESS 1500 (ANTES DEL C.C.)	07-14	8	5.3		11895
EXPRESS 1500 (ANTES DEL C.C.)	07-14	8	5.3		11895
EXPRESS 2500 (ANTES DEL C.C.)	96-02	8	5.7		11173
EXPRESS 2500 (ANTES DEL C.C.)	08-10	8	6.0		11895
EXPRESS 2500 (ANTES DEL C.C.)	13-15	8	6.0		11895
EXPRESS 3500 (ANTES DEL C.C.)	96-02	8	5.7		11173
EXPRESS 3500 (ANTES DEL C.C.) / (DESPUÉS DEL C.C.) - DERECHO	03-07	8	6.0		11170
EXPRESS 3500 (ANTES DEL C.C.)	08-10	8	6.0		11895
EXPRESS 3500 (ANTES DEL C.C.)	13-15	8	6.0		11895
EXPRESS CARGO VAN (ANTES DEL C.C.)	07-14	6	4.3		11895
EXPRESS CARGO VAN (ANTES DEL C.C.)	07-14	8	6.0		11895
HHR (DESPUÉS DEL C.C.)	06-09	4	2.4		11170
HHR (ANTES DEL C.C.)	06-07	4	2.4		11879
IMPALA (DESPUÉS DEL C.C.)	00-03	6	3.4		11170
IMPALA (ANTES DEL C.C.)	00-00	6	3.4		11172
IMPALA (ANTES DEL C.C.)	01-03	6	3.4		11280
IMPALA (DESPUÉS DEL C.C.)	00-03	6	3.8		11170
IMPALA (ANTES DEL C.C.)	00-03	6	3.8		11172

CONTINÚA»



# SENSORES DE OXÍGENO

**A/F** (AIR FUEL RATIO SENSOR)

**S/C** (SIN CONECTOR)

**5 CAB.** (5 CABLES)

GENERAL MOTORS		CHEVROLET				
MODELO	AÑO	CIL.	MOTOR	SISTEMA	No. PARTE	
LUMINA (DESPUÉS DEL C.C.)	96-96	6	3.4		11170	
LUV (ANTES DEL C.C.)	98-05	4	2.2		11066	
LUV (ANTES DEL C.C.) <b>S/C</b>	98-05	4	2.2		11979	
MALIBU (DESPUÉS DEL C.C.)	04-07	4	2.2		11170	
MALIBU (ANTES DEL C.C.)	04-06	4	2.2		11172	
MALIBU (ANTES DEL C.C.)	07-07	4	2.2		11280	
MALIBU (ANTES DEL C.C.)	97-00	4	2.4		11282	
MALIBU (ANTES DEL C.C.)	97-00	6	3.1		11172	
MALIBU (ANTES DEL C.C.)	01-03	6	3.1	MPFI	11280	
MALIBU (ANTES DEL C.C.)	04-07	6	3.5		11280	
MALIBU (DESPUÉS DEL C.C.)	04-07	6	3.5		11625	
MALIBU (ANTES DEL C.C.)	08-11	6	3.6		11280	
MALIBU (DESPUÉS DEL C.C.) <b>NUEVO</b>	08-12	6	3.6		11866	
MALIBU LT (ANTES DEL C.C.)	10-10	4	2.4		11879	
MATIZ (ANTES DEL C.C.)	11-15	4	1.0		11964	
MATIZ (DESPUÉS DEL C.C.)	11-15	4	1.0		11996	
MERIVA (ANTES DEL C.C.)	04-04	4	1.8		11001	
MERIVA (ANTES DEL C.C.) <b>S/C</b>	04-04	4	1.8		11011	
MICROBUS (ANTES DEL C.C.)	93-99	8	5.7	TBI	11001	
MICROBUS (ANTES DEL C.C.) <b>S/C</b>	93-99	8	5.7		11011	
OPTRA (ANTES DEL C.C.)	06-10	4	2.0	MPFI	11964	
P30 (ANTES DEL C.C.)	93-99	8	5.7	TBI	11001	
P30 (ANTES DEL C.C.) <b>S/C</b>	93-99	8	5.7		11011	
P30 (ANTES DEL C.C.) / IZQUIERDO Y DERECHO	96-99	8	5.7		11646	
S10 (ANTES DEL C.C.)	96-01	4	2.2	MPFI	11001	
S10 (ANTES DEL C.C.) <b>S/C</b>	96-01	4	2.2		11011	
S10 (DESPUÉS DEL C.C.)	97-03	4	2.2		11170	
S10 MAXICAB (ANTES DEL C.C.)	91-93	6	3.1	TBI	11001	
S10 MAXICAB (ANTES DEL C.C.) <b>S/C</b>	91-93	6	3.1		11011	
SILVERADO 1500 (ANTES DEL C.C.)	00-02	6	4.3		11066	
SILVERADO 1500 (ANTES DEL C.C.) <b>S/C</b>	00-02	6	4.3		11979	
SILVERADO 2500 (ANTES DEL C.C.)	99-02	8	5.3		11173	
SILVERADO 2500 (ANTES DEL C.C.) / (DESPUÉS DEL C.C.)	03-09	8	5.3		11280	
SILVERADO 2500 (ANTES DEL C.C.)	01-02	8	5.3		11636	
SILVERADO 3500 (ANTES DEL C.C.)	99-02	8	5.7		11645	
SILVERADO 3500 (ANTES DEL C.C.)	01-01	8	6.0		11173	
SILVERADO 3500 (ANTES DEL C.C.) - DERECHO / IZQUIERDO	03-06	8	6.0		11283	
SILVERADO 3500 (ANTES DEL C.C.) - DERECHO / IZQUIERDO	03-06	8	8.1		11283	
SILVERADO 3500 (DESPUÉS DEL C.C.) - IZQUIERDO	03-06	8	8.1	MPFI	11879	
SILVERADO 3500 HD (ANTES DEL C.C.)	01-02	8	8.1		11645	
SILVERADO 3500 HD CAB Y CHASIS (DESPUÉS DEL C.C.) <b>NUEVO</b>	08-10	8	6.0		11866	
SONIC (DESPUÉS DEL C.C.)	12-17	4	1.6		11903	
SONIC (ANTES DEL C.C.)	12-17	4	1.6		11966	
SONORA (ANTES DEL C.C.) / (DESPUÉS DEL C.C.)	03-05	8	5.7		11280	
SONORA (ANTES DEL C.C.)	00-02	8	5.7		11645	
SPARK CLASSIC (DESPUÉS DEL C.C.)	11-17	4	1.2		11964	
SPARK CLASSIC (ANTES DEL C.C.)	11-17	4	1.2		11996	
SUBURBAN (ANTES DEL C.C.)	08-11	8	5.3		11894	
SUBURBAN (ANTES DEL C.C.)	93-99	8	5.7	TBI	11001	
SUBURBAN (ANTES DEL C.C.) <b>S/C</b>	93-99	8	5.7		11011	
SUBURBAN (ANTES DEL C.C.)	99-99	8	5.7		11645	
SUBURBAN 1500 (ANTES DEL C.C.)	00-02	8	5.3		11173	
SUBURBAN 1500 (ANTES DEL C.C.) / (DESPUÉS DEL C.C.)	03-07	8	5.3		11280	
SUBURBAN 2500 (ANTES DEL C.C.)	00-01	8	6.0		11173	
SUBURBAN 2500 (ANTES DEL C.C.)	07-08	8	6.0		11280	
SUBURBAN 2500 (ANTES DEL C.C.) - DERECHO / IZQUIERDO	03-06	8	6.0		11283	
SUBURBAN 2500 (ANTES DEL C.C.)	08-11	8	6.0		11894	
TAHOE (ANTES DEL C.C.)	07-11	8	5.3		11894	
TORNADO (ANTES DEL C.C.)	11-14	4	1.8	MPFI	11956	
TRACKER (ANTES DEL C.C.) / (DESPUÉS DEL C.C.)	98-98	4	1.6		11916	
TRACKER (ANTES DEL C.C.) / (DESPUÉS DEL C.C.)	99-00	4	2.0		11916	
TRACKER (ANTES DEL C.C.) - DERECHO / IZQUIERDO	02-04	6	2.5		11883	
TRAIL BLAZER (DESPUÉS DEL C.C.)	02-06	6	4.2		11170	
TRAIL BLAZER (ANTES DEL C.C.)	02-03	6	4.2		11284	
TRAIL BLAZER (ANTES DEL C.C.)	04-05	6	4.2		11285	
TRAIL BLAZER (ANTES DEL C.C.) <b>S/C</b>	02-03	6	4.2		11979	

GENERAL MOTORS		CHEVROLET				
MODELO	AÑO	CIL.	MOTOR	SISTEMA	No. PARTE	
TRAIL BLAZER (DESPUÉS DEL C.C.) <b>S/C</b>	02-06	6	4.2		11979	
TRAIL BLAZER (DESPUÉS DEL C.C.)	06-06	8	5.3		11170	
TRAIL BLAZER (ANTES DEL C.C.)	03-05	8	5.3		11279	
TRAIL BLAZER (DESPUÉS DEL C.C.)	03-05	8	5.3		11281	
TRAIL BLAZER EXT (DESPUÉS DEL C.C.)	02-05	6	4.2		11170	
TRAIL BLAZER EXT (DESPUÉS DEL C.C.)	06-06	8	5.3		11170	
TRAIL BLAZER EXT (ANTES DEL C.C.)	03-05	8	5.3		11280	
TRAVERSE (ANTES DEL C.C.) / (DESPUÉS DEL C.C.)	12-15	6	3.6		11170	
TRAVERSE (ANTES DEL C.C.) Y (DESPUÉS DEL C.C.) <b>NUEVO</b>	09-11	6	3.6		11871	
TRAX (ANTES DEL C.C.) / (DESPUÉS DEL C.C.)	13-16	4	1.8		11968	
UPLANDER (DESPUÉS DEL C.C.)	05-06	6	3.5		11170	
UPLANDER (ANTES DEL C.C.)	05-06	6	3.5	MPFI	11280	
UPLANDER (ANTES DEL C.C.)	07-09	6	3.9		11280	
VECTRA (ANTES DEL C.C.)	03-05	6	3.2		11968	
VENTURE (DESPUÉS DEL C.C.)	97-04	6	3.4		11170	
VENTURE (ANTES DEL C.C.)	97-00	6	3.4		11172	
VENTURE (ANTES DEL C.C.)	02-04	6	3.4		11280	
VENTURE (ANTES DEL C.C.) S/C	97-01	6	3.4		11979	
ZAFIRA (ANTES DEL C.C.) / (DESPUÉS DEL C.C.)	02-05	4	1.8		11971	
ZAFIRA (DESPUÉS DEL C.C.)	02-05	4	2.2		11966	
ZAFIRA (ANTES DEL C.C.) / (DESPUÉS DEL C.C.)	02-05	4	2.2		11967	
COLORADO (DESPUÉS DEL C.C.)	07-12	4	2.9		11283	
COLORADO (ANTES DEL C.C.)	07-12	4	2.9		11285	

GENERAL MOTORS		GEO				
MODELO	AÑO	CIL.	MOTOR	SISTEMA	No. PARTE	
TRACKER (ANTES DEL C.C.)	93-95	4	1.6	MPFI	11657	

GENERAL MOTORS		GMC				
MODELO	AÑO	CIL.	MOTOR	SISTEMA	No. PARTE	
ACADIA (ANTES DEL C.C.) / (DESPUÉS DEL C.C.)	12-15	6	3.6		11170	
ACADIA (ANTES DEL C.C.)	07-08	6	3.6		11280	
ACADIA (ANTES DEL C.C.) Y (DESPUÉS DEL C.C.) <b>NUEVO</b>	09-11	6	3.6		11871	
TERRAIN (ANTES DEL C.C.) Y (DESPUÉS DEL C.C.) <b>NUEVO</b>	12-12	6	3.0	MPFI	11871	
TERRAIN (ANTES DEL C.C.) Y (DESPUÉS DEL C.C.) <b>NUEVO</b>	13-15	6	3.6		11871	
YUKON (ANTES DEL C.C.)	08-09	8	5.3		11894	
YUKON (ANTES DEL C.C.)	08-11	8	6.2		11894	

GENERAL MOTORS		HUMMER				
MODELO	AÑO	CIL.	MOTOR	SISTEMA	No. PARTE	
H2 (ANTES DEL C.C.)	03-06	8	6.0	MPFI	11283	
H2 (DESPUÉS DEL C.C.) <b>NUEVO</b>	09-09	8	6.2		11866	

GENERAL MOTORS		OLDSMOBILE				
MODELO	AÑO	CIL.	MOTOR	SISTEMA	No. PARTE	
88 (ANTES DEL C.C.)	92-94	6	3.8		11001	
88 (ANTES DEL C.C.) <b>S/C</b>	92-94	6	3.8	MPFI	11011	
CUTLASS (ANTES DEL C.C.)	91-95	6	3.1		11001	
CUTLASS (ANTES DEL C.C.) <b>S/C</b>	91-95	6	3.1		11011	
SILHOUETTE (ANTES DEL C.C.)	91-94	6	3.1		11001	
SILHOUETTE (ANTES DEL C.C.) <b>S/C</b>	91-94	6	3.1	TBI	11011	
SILHOUETTE (ANTES DEL C.C.) <b>S/C</b>	91-94	6	3.8		11001	
SILHOUETTE (ANTES DEL C.C.) <b>S/C</b>	91-94	6	3.8		11011	

GENERAL MOTORS		PONTIAC				
MODELO	AÑO	CIL.	MOTOR	SISTEMA	No. PARTE	
AZTEK (DESPUÉS DEL C.C.)	01-04	6	3.4		11170	
AZTEK (ANTES DEL C.C.)	01-05	6	3.4		11279	
BONNEVILLE (ANTES DEL C.C.)	94-96	6	3.8		11066	
BONNEVILLE (DESPUÉS DEL C.C.)	96-99	6	3.8		11170	
BONNEVILLE (ANTES DEL C.C.)	97-99	6	3.8	MPFI	11172	
BONNEVILLE (ANTES DEL C.C.) <b>S/C</b>	94-96	6	3.8		11979	
BONNEVILLE (DESPUÉS DEL C.C.) <b>S/C</b>	96-99	6	3.8		11979	
G3 (ANTES DEL C.C.)	07-09	4	1.6		11964	
G5 GT (ANTES DEL C.C.)	07-08	4	2.4		11280	
G6 (DESPUÉS DEL C.C.)	06-06	6	3.5		11170	

CONTINUÁ

**A/F (AIR FUEL RATIO SENSOR)**

**S/C (SIN CONECTOR)**

**5 CAB. (5 CABLES)**

GENERAL MOTORS		PONTIAC			
MODELO	AÑO	CIL.	MOTOR	SISTEMA	No. PARTE
G6 (ANTES DEL C.C.) / (DESPUÉS DEL C.C.) - DERECHO	05-09	6	3.5		11280
G6 (ANTES DEL C.C.)	08-09	6	3.6		11280
G6 (DESPUÉS DEL C.C.) <b>NUEVO</b>	08-09	6	3.6		11866
GRAND AM (DESPUÉS DEL C.C.)	99-04	6	3.4		11170
GRAND AM (ANTES DEL C.C.)	99-00	6	3.4		11172
GRAND AM (ANTES DEL C.C.)	01-04	6	3.4		11280
GRAND AM (ANTES DEL C.C.) <b>S/C</b>	99-04	6	3.4		11979
GRAND PRIX (DESPUÉS DEL C.C.)	97-01	6	3.1		11170
GRAND PRIX S/C (ANTES DEL C.C.)	97-01	6	3.8		11172
GRAND PRIX (DESPUÉS DEL C.C.)	97-01	6	3.8	MPFI	11170
MATIZ (ANTES DEL C.C.)	04-10	4	1.0		11964
MATIZ (DESPUÉS DEL C.C.)	04-10	4	1.0		11996
MONTANA (ANTES DEL C.C.)	05-06	6	3.5		11280
MONTANA (ANTES DEL C.C.)	06-06	6	3.9		11280
SOLSTICE (ANTES DEL C.C.)	06-07	4	2.4		11280
SUNFIRE (ANTES DEL C.C.) <b>S/C</b>	97-00	4	2.4		11011
SUNFIRE (ANTES DEL C.C.)	97-00	4	2.4		11282
SUNFIRE (ANTES DEL C.C.)	01-02	4	2.4		11627
TORRENT (ANTES DEL C.C.)	06-09	6	3.4		11280

HONDA					
MODELO	AÑO	CIL.	MOTOR	SISTEMA	No. PARTE
ACCORD (DESPUÉS DEL C.C.) <b>S/C</b>	98-01	4	2.3		11503
ACCORD (ANTES DEL C.C.) <b>A/F</b>	98-02	4	2.3		11655
ACCORD (DESPUÉS DEL C.C.)	98-01	4	2.3		11953
ACCORD (ANTES DEL C.C.) <b>S/C A/F</b>	03-07	4	2.4		11550
ACCORD (DESPUÉS DEL C.C.)	03-07	4	2.4		11656
ACCORD (ANTES DEL C.C.) <b>A/F</b>	08-12	4	2.4		11897
ACCORD (ANTES DEL C.C.) <b>A/F</b>	03-07	4	2.4		11999
ACCORD (DESPUÉS DEL C.C.) <b>S/C</b>	98-99	6	3.0		11503
ACCORD (ANTES DEL C.C.) <b>S/C</b>	98-02	6	3.0		11503
ACCORD (ANTES DEL C.C.)	00-02	6	3.0		11663
ACCORD (ANTES DEL C.C.)	98-99	6	3.0		11949
ACCORD (DESPUÉS DEL C.C.) CONECTOR MACHO	98-99	6	3.0		11952
ACCORD (DESPUÉS DEL C.C.)	00-02	6	3.0		11953
ACCORD (ANTES DEL C.C.) BANDA ANCHA / 5 CAB.	03-08	6	3.0		11997
CITY (ANTES DEL C.C.) <b>A/F</b>	10-16	4	1.5		11897
CIVIC (ANTES DEL C.C.) / (DESPUÉS DEL C.C.) <b>S/C</b>	97-00	4	1.6		11503
CIVIC (ANTES DEL C.C.)	97-00	4	1.6		11949
CIVIC (DESPUÉS DEL C.C.)	97-00	4	1.6		11950
CIVIC (ANTES DEL C.C.) <b>A/F</b>	01-03	4	1.7		11951
CIVIC (ANTES DEL C.C.) <b>S/C A/F</b>	06-11	4	1.8		11550
CIVIC (ANTES DEL C.C.)	06-15	4	1.8		11873
CIVIC HIBRIDO (DESPUÉS DEL C.C.)	12-13	4	1.5	MPFI	11681
CIVIC HIBRIDO (ANTES DEL C.C.) <b>A/F</b>	12-13	4	1.5		11897
CIVIC SI (ANTES DEL C.C.) <b>S/C A/F</b>	07-09	4	2.0		11550
CIVIC SI (DESPUÉS DEL C.C.)	12-13	4	2.4		11681
CIVIC SI (ANTES DEL C.C.) <b>A/F</b>	12-15	4	2.4		11897
CR-V (ANTES DEL C.C.) <b>S/C A/F</b>	07-11	4	2.4		11550
CR-V (DESPUÉS DEL C.C.)	10-14	4	2.4		11681
CR-V (ANTES DEL C.C.) <b>A/F</b> <b>NUEVO</b>	07-09	4	2.4		11868
CR-V (ANTES DEL C.C.) <b>A/F</b>	10-14	4	2.4		11897
CR-V (ANTES DEL C.C.) <b>A/F</b>	02-06	4	2.4		11951
CR-V (DESPUÉS DEL C.C.)	02-06	4	2.4		11953
CR-Z HIBRIDO (ANTES DEL C.C.) <b>A/F</b>	13-15	4	1.5		11897
FIT (ANTES DEL C.C.) <b>A/F</b>	06-14	4	1.5		11897
ODYSSEY (ANTES DEL C.C.) / (DESPUÉS DEL C.C.) <b>S/C</b>	01-04	6	3.5		11503
ODYSSEY (ANTES DEL C.C.)	03-04	6	3.5		11663
ODYSSEY (ANTES DEL C.C.)	01-02	6	3.5		11949
ODYSSEY (DESPUÉS DEL C.C.)	01-03	6	3.5		11953
ODYSSEY (ANTES DEL C.C.) BANDA ANCHA / 5 CAB.	05-06	6	3.5		11997
ODYSSEY TOURING (DESPUÉS DEL C.C.) - DELANTERO	11-13	6	3.5		11679
PILOT (ANTES DEL C.C.) BANDA ANCHA / 5 CAB.	05-08	6	3.5		11997
RIDGELINE (ANTES DEL C.C.) BANDA ANCHA / 5 CAB.	07-08	6	3.5		11997

MAZDA					
MODELO	AÑO	CIL.	MOTOR	SISTEMA	No. PARTE
2 (DESPUÉS DEL C.C.)	12-15	4	1.5		11661
3 (DESPUÉS DEL C.C.)	06-09	4	2.0		11661
3 (DESPUÉS DEL C.C.)	10-13	4	2.0		11683
3 (DESPUÉS DEL C.C.) <b>NUEVO</b>	14-14	4	2.0		11861
3 (ANTES DEL C.C.) BANDA ANCHA / 5 CAB <b>NUEVO</b>	06-13	4	2.0		11863
3 (ANTES DEL C.C.) BANDA ANCHA <b>NUEVO</b>	14-14	4	2.0		11867
3 (DESPUÉS DEL C.C.)	06-09	4	2.3		11661
3 (ANTES DEL C.C.) BANDA ANCHA <b>NUEVO</b>	06-09	4	2.3		11863
3 (DESPUÉS DEL C.C.)	11-13	4	2.5		11669
3 (DESPUÉS DEL C.C.)	10-10	4	2.5		11683
3 (DESPUÉS DEL C.C.) <b>NUEVO</b>	14-14	4	2.5		11861
3 (ANTES DEL C.C.) BANDA ANCHA / 5 CAB. <b>NUEVO</b>	14-14	4	2.5		11867
5 (ANTES DEL C.C.)	06-07	4	2.3		11665
5 (ANTES DEL C.C.) BANDA ANCHA / 5 CAB. <b>NUEVO</b>	08-10	4	2.3		11863
5 (DESPUÉS DEL C.C.)	08-10	4	2.3		11876
5 (DESPUÉS DEL C.C.)	12-15	4	2.5		11669
6 (DESPUÉS DEL C.C.)	06-08	4	2.3		11661
6 (ANTES DEL C.C.) BANDA ANCHA / 5 CAB. <b>NUEVO</b>	06-08	4	2.3		11862
6 (DESPUÉS DEL C.C.) <b>NUEVO</b>	14-15	4	2.5		11861
6 (ANTES DEL C.C.) BANDA ANCHA / 5 CAB. <b>NUEVO</b>	09-13	4	2.5		11864
6 (ANTES DEL C.C.) BANDA ANCHA / 5 CAB. <b>NUEVO</b>	14-15	4	2.5		11867
6 (DESPUÉS DEL C.C.)	09-13	4	2.5	MPFI	11891
6 (ANTES DEL C.C.) - TRASERO	06-08	6	3.0		11674
6 (DESPUÉS DEL C.C.) - TRASERO	06-08	6	3.0		11874
6 (ANTES DEL C.C.) FRONT.	06-08	6	3.0		11881
6 (ANTES DEL C.C.) BANDA ANCHA / 5 CAB. <b>NUEVO</b>	11-13	6	3.7		11872
6 (DESPUÉS DEL C.C.)	11-13	6	3.7		11884
CX-3 (ANTES DEL C.C.) BANDA ANCHA / 5 CAB. <b>NUEVO</b>	16-17	4	2.0		11867
CX-5 (DESPUÉS DEL C.C.) <b>NUEVO</b>	13-15	4	2.0		11861
CX-5 (ANTES DEL C.C.) BANDA ANCHA / 5 CAB. <b>NUEVO</b>	13-15	4	2.0		11867
CX-5 (DESPUÉS DEL C.C.) <b>NUEVO</b>	14-15	4	2.5		11861
CX-5 (ANTES DEL C.C.) BANDA ANCHA / 5 CAB. <b>NUEVO</b>	14-15	4	2.5		11867
CX-7 (DESPUÉS DEL C.C.)	10-12	4	2.5		11668
CX-7 (ANTES DEL C.C.) BANDA ANCHA / 5 CAB. <b>NUEVO</b>	10-12	4	2.5		11869
CX-7 TURBO (DESPUÉS DEL C.C.)	07-12	4	2.3		11671
CX-9 (ANTES DEL C.C.) / (DESPUÉS DEL C.C.)	07-07	6	3.5		11098
CX-9 (ANTES DEL C.C.) / (DESPUÉS DEL C.C.)	08-10	6	3.7		11098
CX-9 (ANTES DEL C.C.) BANDA ANCHA / 5 CAB. <b>NUEVO</b>	11-14	6	3.7		11872
CX-9 (DESPUÉS DEL C.C.)	11-14	6	3.7		11884
MX-5 MIATA (DESPUÉS DEL C.C.)	06-12	4	2.0		11888

MERCEDES BENZ					
MODELO	AÑO	CIL.	MOTOR	SISTEMA	No. PARTE
C200 (ANTES DEL C.C.) - (DESPUÉS DEL C.C.)	01-04	4	2.0		11945
C230 (ANTES DEL C.C.)	97-00	4	2.3		11945
C280 (ANTES DEL C.C.) - DERECHO	98-00	6	2.8		11940
C280 (DESPUÉS DEL C.C.)	98-00	6	2.8		11941
C280 (ANTES DEL C.C.) - IZQUIERDO	98-00	6	2.8		11942
C280 (ANTES DEL C.C.)	95-97	6	2.8		11943
C280 (DESPUÉS DEL C.C.) <b>NUEVO</b>	06-07	6	3.0		11865
C320 (ANTES DEL C.C.) - DERECHO	01-03	6	3.2		11937
C320 (DESPUÉS DEL C.C.) - IZQUIERDO	01-03	6	3.2		11938
C320 (ANTES DEL C.C.) - IZQUIERDO	01-03	6	3.2		11941
C350 (DESPUÉS DEL C.C.) <b>NUEVO</b>	06-11	6	3.5	MPFI	11865
CLK320 (DESPUÉS DEL C.C.) - IZQUIERDO	98-00	6	3.2		11939
CLK320 (ANTES DEL C.C.) - DERECHO	98-00	6	3.2		11940
CLK320 (ANTES DEL C.C.) - IZQUIERDO	98-00	6	3.2		11942
CLK350 (DESPUÉS DEL C.C.) <b>NUEVO</b>	06-09	6	3.5		11865
CLS350 (DESPUÉS DEL C.C.) <b>NUEVO</b>	07-11	6	3.5		11865
E350 (DESPUÉS DEL C.C.) <b>NUEVO</b>	06-11	6	3.5		11865
GL450 (DESPUÉS DEL C.C.) <b>NUEVO</b>	07-09	8	4.6		11865
GLK350 (DESPUÉS DEL C.C.) <b>NUEVO</b>	10-12	6	3.5		11865
ML350 (DESPUÉS DEL C.C.) <b>NUEVO</b>	06-11	6	3.5		11865
SLK350 (DESPUÉS DEL C.C.) <b>NUEVO</b>	06-11	6	3.5		11865

# SENSORES DE OXÍGENO

**A/F** (AIR FUEL RATIO SENSOR)

**S/C** (SIN CONECTOR)

**5 CAB.** (5 CABLES)

MINI					
MODELO	AÑO	CIL.	MOTOR	SISTEMA	No. PARTE
MINI COOPER (DESPUÉS DEL C.C.)	07-15	4	1.6	MPFI	11678
MINI COOPER (ANTES DEL C.C.) / (DESPUÉS DEL C.C.)	02-08	4	1.6		11685
MINI COOPER COUNTRYMAN (DESPUÉS DEL C.C.)	11-15	4	1.6		11678
MINI COOPER PACEMAN (DESPUÉS DEL C.C.)	13-15	4	1.6		11678

MITSUBISHI					
MODELO	AÑO	CIL.	MOTOR	SISTEMA	No. PARTE
ECLIPSE (ANTES DEL C.C.)	03-05	6	3.0	MPFI	11936
ECLIPSE (ANTES DEL C.C.) - FRONTAL / TRASERO	06-12	6	3.8		11892
ENDEAVOR (ANTES DEL C.C.)	04-11	6	3.8		11892
ENDEAVOR (ANTES DEL C.C.)	04-11	6	3.8		11936
GALANT (ANTES DEL C.C.)	03-03	6	3.0		11936
GALANT (ANTES DEL C.C.) - FRONTAL / TRASERO	04-09	6	3.8		11892
LANCER (DESPUÉS DEL C.C.)	04-07	4	2.0		11882
LANCER (ANTES DEL C.C.)	04-07	4	2.0		11936
LANCER RALLIART (ANTES DEL C.C.)	05-06	4	2.4		11677
MONTERO (ANTES DEL C.C.) - DERECHO	03-06	6	3.8		11936
MONTERO SPORT (ANTES DEL C.C.) - DERECHO	03-04	6	3.5		11936
OUTLANDER (ANTES DEL C.C.)	04-06	4	2.4		11875
OUTLANDER (DESPUÉS DEL C.C.)	07-11	6	3.0		11880
OUTLANDER (ANTES DEL C.C.) FRONTAL	07-11	6	3.0		11892

NISSAN		INFINITI			
MODELO	AÑO	CIL.	MOTOR	SISTEMA	No. PARTE
I30 (DESPUÉS DEL C.C.)	00-01	6	3.0	MPFI	11977
Q45 (ANTES DEL C.C.) / (DESPUÉS DEL C.C.)	02-06	8	4.5		11957

NISSAN		INFINITI			
MODELO	AÑO	CIL.	MOTOR	SISTEMA	No. PARTE
350Z (ANTES DEL C.C.) A/F	08-08	6	3.5	MPFI	11896
370Z (ANTES DEL C.C.) A/F	11-15	6	3.7		11660
370Z (ANTES DEL C.C.) A/F	09-10	6	3.7		11896
ALMERA (ANTES DEL C.C.)	04-05	4	1.8		11909
ALMERA (ANTES DEL C.C.)	02-03	4	1.8		11976
ALTIMA (ANTES DEL C.C.) 5 CAB.	04-06	4	2.5		11501
ALTIMA (ANTES DEL C.C.)	07-10	4	2.5		11902
ALTIMA (ANTES DEL C.C.) 5 CAB.	04-06	4	2.5		11908
ALTIMA DESPUÉS DEL C.C.	07-10	4	2.5		11909
ALTIMA DESPUÉS DEL C.C.	04-06	4	2.5		11957
ALTIMA DESPUÉS DEL C.C.	02-03	4	2.5		11959
ALTIMA (ANTES DEL C.C.) 5 CAB.	04-06	6	3.5		11501
ALTIMA (ANTES DEL C.C.) - FRONTAL DELANTERO A/F	14-16	6	3.5		11660
ALTIMA (ANTES DEL C.C.)	11-12	6	3.5		11896
ALTIMA (ANTES DEL C.C.)	07-10	6	3.5		11902
ALTIMA (ANTES DEL C.C.) 5 CAB.	04-06	6	3.5		11908
ALTIMA (DESPUÉS DEL C.C.)	07-12	6	3.5		11909
ALTIMA (DESPUÉS DEL C.C.)	05-06	6	3.5		11957
ALTIMA (DESPUÉS DEL C.C.)	02-04	6	3.5		11959
ARMADA (ANTES DEL C.C.) 5 CAB.	05-06	8	5.6		11501
ARMADA (ANTES DEL C.C.)	14-15	8	5.6		11660
ARMADA (ANTES DEL C.C.)	07-13	8	5.6		11902
ARMADA (ANTES DEL C.C.) 5 CAB.	05-06	8	5.6		11908
ARMADA (DESPUÉS DEL C.C.)	05-15	8	5.6		11957
D21 (ANTES DEL C.C.) S/C	87-96	4	2.4		11011
D21 (DESPUÉS DEL C.C.)	97-08	4	2.4		11957
D21 (ANTES DEL C.C.)	04-08	4	2.4		11959
D21 (ANTES DEL C.C.)	97-03	4	2.4		11983
D21 (ANTES DEL C.C.)	94-96	4	2.4		11993
FRONTIER (ANTES DEL C.C.)	06-10	4	2.4		11501
FRONTIER DESPUÉS DEL C.C.	02-04	4	2.4		11654
FRONTIER (ANTES DEL C.C.) 5 CAB.	06-10	4	2.4		11908
FRONTIER (DESPUÉS DEL C.C.)	06-10	4	2.4		11957
FRONTIER (ANTES DEL C.C.)	02-05	4	2.4		11976
FRONTIER (ANTES DEL C.C.)	13-14	6	4.0		11660
FRONTIER (ANTES DEL C.C.) A/F	11-12	6	4.0		11896
FRONTIER (ANTES DEL C.C.) A/F	08-10	6	4.0		11902

NISSAN		INFINITI			
MODELO	AÑO	CIL.	MOTOR	SISTEMA	No. PARTE
MARCH (ANTES DEL C.C.) A/F	12-18	4	1.6	MPFI	11660
MARCH (DESPUÉS DEL C.C.)	12-18	4	1.6		11998
MAXIMA (DESPUÉS DEL C.C.) - FRONTAL	01-01	6	3.0		11977
MAXIMA (ANTES DEL C.C.) A/F	14-15	6	3.5		11660
MAXIMA (ANTES DEL C.C.) A/F	10-13	6	3.5		11896
MAXIMA (DESPUÉS DEL C.C.)	04-08	6	3.5		11959
MURANO (ANTES DEL C.C.) S/C 5 CAB.	06-07	6	3.5		11501
MURANO (ANTES DEL C.C.) - IZQUIERDO A/F	11-14	6	3.5		11660
MURANO (ANTES DEL C.C.) A/F	09-10	6	3.5		11902
MURANO (ANTES DEL C.C.) 5 CAB.	04-08	6	3.5		11908
MURANO (DESPUÉS DEL C.C.)	09-10	6	3.5		11909
MURANO (DESPUÉS DEL C.C.)	07-08	6	3.5		11957
MURANO (DESPUÉS DEL C.C.)	04-06	6	3.5		11959
NOTE (ANTES DEL C.C.) A/F	14-18	4	1.6		11660
NOTE (DESPUÉS DEL C.C.)	14-18	4	1.6		11998
NP300 (ANTES DEL C.C.)	09-15	4	2.4		11959
NV2500 (ANTES DEL C.C.) - DERECHO / IZQUIERDO A/F	13-14	6	4.0		11660
PATHFINDER (ANTES DEL C.C.) - DERECHO / IZQUIERDO A/F	13-16	6	3.5		11660
PATHFINDER (DESPUÉS DEL C.C.) - DERECHO	03-03	6	3.5		11877
PATHFINDER (DESPUÉS DEL C.C.)	01-02	6	3.5		11957
PATHFINDER (ANTES DEL C.C.)	03-04	6	3.5		11957
PATHFINDER (ANTES DEL C.C.) - DERECHO	00-02	6	3.5		11976
PATHFINDER (ANTES DEL C.C.) S/C 5 CAB.	05-06	6	4.0		11501
PATHFINDER (ANTES DEL C.C.) A/F	11-12	6	4.0		11896
PATHFINDER (ANTES DEL C.C.) A/F	07-10	6	4.0		11902
PATHFINDER (ANTES DEL C.C.) 5 CAB.	05-06	6	4.0		11908
PATHFINDER (DESPUÉS DEL C.C.)	05-12	6	4.0		11957
PLATINA (ANTES DEL C.C.) / (DESPUÉS DEL C.C.)	02-10	4	1.6		11972
QUEST (DESPUÉS DEL C.C.)	99-02	6	3.3		11659
QUEST (ANTES DEL C.C.) S/C 5 CAB.	06-09	6	3.5		11501
QUEST (ANTES DEL C.C.) 5 CAB.	04-09	6	3.5		11908
QUEST (DESPUÉS DEL C.C.)	04-09	6	3.5		11959
ROGUE (ANTES DEL C.C.) A/F	11-14	4	2.5		11896
ROGUE (ANTES DEL C.C.) A/F	08-10	4	2.5	11902	
ROGUE (DESPUÉS DEL C.C.)	08-14	4	2.5	11909	
SENTRA (ANTES DEL C.C.) S/C	92-92	4	1.6	11011	
SENTRA (ANTES DEL C.C.) S/C	96-00	4	1.6	11011	
SENTRA (ANTES DEL C.C.)	92-92	4	1.6	11058	
SENTRA (ANTES DEL C.C.)	96-00	4	1.6	11991	
SENTRA (ANTES DEL C.C.) A/F	13-15	4	1.8	11660	
SENTRA (DESPUÉS DEL C.C.)	01-06	4	1.8	11957	
SENTRA (ANTES DEL C.C.)	01-06	4	1.8	11976	
SENTRA (ANTES DEL C.C.) A/F	10-12	4	2.0	11896	
SENTRA (ANTES DEL C.C.) A/F	07-09	4	2.0	11902	
SENTRA (DESPUÉS DEL C.C.)	07-12	4	2.0	11909	
SENTRA SE-R (ANTES DEL C.C.) A/F	07-12	4	2.5	11902	
SENTRA SE-R (ANTES DEL C.C.) 5 CAB.	05-06	4	2.5	11908	
SENTRA SE-R (DESPUÉS DEL C.C.)	07-12	4	2.5	11909	
SENTRA SE-R (ANTES DEL C.C.)	02-04	4	2.5	11957	
TIIDA (ANTES DEL C.C.) A/F	13-18	4	1.6	11660	
TIIDA (DESPUÉS DEL C.C.)	13-18	4	1.6	11998	
TIIDA (ANTES DEL C.C.) / (DESPUÉS DEL C.C.)	07-18	4	1.8	11909	
TITAN (ANTES DEL C.C.) A/F	13-15	8	5.6	11660	
TITAN (ANTES DEL C.C.) A/F	08-12	8	5.6	11902	
TITAN (ANTES DEL C.C.) 5 CAB.	04-06	8	5.6	11908	
TITAN (DESPUÉS DEL C.C.)	04-15	8	5.6	11957	
TSUBAME (ANTES DEL C.C.) S/C	93-96	4	1.6	11011	
TSUBAME (ANTES DEL C.C.)	93-96	4	1.6	11991	
TSURU III (ANTES DEL C.C.) S/C	93-02	4	1.6	11011	
TSURU III (ANTES DEL C.C.)	93-96	4	1.6	11019	
TSURU III (ANTES DEL C.C.) / (DESPUÉS DEL C.C.)	05-16	4	1.6	11957	
TSURU III (ANTES DEL C.C.)	03-04	4	1.6	11983	
TSURU III (ANTES DEL C.C.)	93-96	4	1.6	11991	
TSURU III (ANTES DEL C.C.)	96-02	4	1.6	11991	
TSURU III GSR 2000 (ANTES DEL C.C.)	94-96	4	2.0	11992	
URVAN (ANTES DEL C.C.)	02-06	4	2.4	11976	

CONTINÚA >>>



**A/F (AIR FUEL RATIO SENSOR)**

**S/C (SIN CONECTOR)**

**5 CAB. (5 CABLES)**

NISSAN		INFINITI			
MODELO	AÑO	CIL.	MOTOR	SISTEMA	No. PARTE
URVAN (ANTES DEL C.C.) / (DESPUÉS DEL C.C.)	08-13	4	2.5	MPFI	11909
URVAN NV350 (DESPUÉS DEL C.C.) - BANCO 1	14-17	4	2.5		11893
VERSA (ANTES DEL C.C.) <b>A/F</b>	12-18	4	1.6		11660
VERSA (DESPUÉS DEL C.C.)	12-18	4	1.6		11998
XTERRA (DESPUÉS DEL C.C.)	00-04	4	2.4		11654
XTERRA (ANTES DEL C.C.)	00-00	4	2.4		11978
XTERRA (ANTES DEL C.C.) <b>S/C 5 CAB.</b>	06-07	6	4.0		11501
XTERRA (ANTES DEL C.C.)	06-07	6	4.0		11908
XTERRA (DESPUÉS DEL C.C.)	05-07	6	4.0		11957
X-TRAIL (DESPUÉS DEL C.C.)	03-03	4	2.5		11877
X-TRAIL (ANTES DEL C.C.)	08-14	4	2.5		11909
X-TRAIL (ANTES DEL C.C.)	02-07	4	2.5		11959

PEUGEOT					
MODELO	AÑO	CIL.	MOTOR	SISTEMA	No. PARTE
206 ANTES DEL C.C.	00-04	4	1.4	MPFI	11907
206 ANTES DEL C.C.	01-04	4	1.6		11907
307 ANTES DEL C.C.	03-04	4	2.0		11907
607 ANTES DEL C.C.	04-04	6	3.0		11907
206 XT ANTES DEL C.C.	00-04	4	1.4		11970

RENAULT					
MODELO	AÑO	CIL.	MOTOR	SISTEMA	No. PARTE
CLIO (ANTES DEL C.C.) / (DESPUÉS DEL C.C.)	02-10	4	1.6	MPFI	11972
KANGOO (ANTES DEL C.C.)	04-11	4	1.6		11972
MEGANE (ANTES DEL C.C.) / (DESPUÉS DEL C.C.)	02-03	4	2.0		11972

SEAT					
MODELO	AÑO	CIL.	MOTOR	SISTEMA	No. PARTE
IBIZA ANTES DEL C.C.	09-15	4	2.0	MPFI	11980
IBIZA (DESPUÉS DEL C.C.)	09-15	4	2.0		11984
LEON ANTES DEL C.C. <b>A/F 5 CAB.</b>	07-07	4	2.0		11913

SMART					
MODELO	AÑO	CIL.	MOTOR	SISTEMA	No. PARTE
FORTWO (DESPUÉS DEL C.C.) <b>NUEVO</b>	08-15	3	1.0	MPFI	11865

SUZUKI					
MODELO	AÑO	CIL.	MOTOR	SISTEMA	No. PARTE
AERIO ANTES DEL C.C.	06-07	4	2.3	MPFI	11883
GRAND VITARA (DESPUÉS DEL C.C.)	09-13	4	2.4		11890
GRAND VITARA (DESPUÉS DEL C.C.)	06-08	6	2.7		11676
GRAND VITARA (DESPUÉS DEL C.C.) - DERECHO / IZQUIERDO	09-10	6	3.2		11886

TOYOTA					
MODELO	AÑO	CIL.	MOTOR	SISTEMA	No. PARTE
4RUNNER (ANTES DEL C.C.) <b>A/F</b>	06-09	6	4.0	MPFI	11653
4RUNNER (DESPUÉS DEL C.C.)	06-09	6	4.0		11946
4RUNNER (ANTES DEL C.C.) <b>A/F</b>	05-09	8	4.7		11653
4RUNNER (ANTES DEL C.C.) <b>NUEVO</b>	03-04	8	4.7		11859
4RUNNER (DESPUÉS DEL C.C.) S/C ALTA RESISTENCIA	03-09	8	4.7		11924
4RUNNER (DESPUÉS DEL C.C.)	03-09	8	4.7		11946
4RUNNER (ANTES DEL C.C.)	03-04	8	4.7		11947
AVANZA (ANTES DEL C.C.) <b>NUEVO</b>	07-15	4	1.5		11859
CAMRY (ANTES DEL C.C.) <b>A/F</b>	02-03	4	2.4		11647
CAMRY (DESPUÉS DEL C.C.)	02-03	4	2.4		11648
CAMRY (ANTES DEL C.C.) <b>A/F</b>	04-11	4	2.4		11899
CAMRY (DESPUÉS DEL C.C.)	04-11	4	2.4		11925
CAMRY (ANTES DEL C.C.) <b>A/F</b>	10-16	4	2.5		11899
CAMRY (DESPUÉS DEL C.C.)	10-16	4	2.5		11910
CAMRY (ANTES DEL C.C.) - FRONTAL / TRASERO <b>A/F</b>	02-06	6	3.0		11899
CAMRY (DESPUÉS DEL C.C.) S/C ALTA RESISTENCIA	02-06	6	3.0		11924
CAMRY (DESPUÉS DEL C.C.) - FRONTAL	02-06	6	3.0		11946
CAMRY (DESPUÉS DEL C.C.) - TRASERO	02-06	6	3.0		11947
CAMRY (ANTES DEL C.C.) <b>A/F</b>	07-16	6	3.5		11647
CAMRY (DESPUÉS DEL C.C.) - IZQUIERDO	07-16	6	3.5		11946

TOYOTA					
MODELO	AÑO	CIL.	MOTOR	SISTEMA	No. PARTE
CAMRY (DESPUÉS DEL C.C.) - DERECHO	07-16	6	3.5	MPFI	11947
COROLLA (DESPUÉS DEL C.C.)	05-08	4	1.8		11649
COROLLA (ANTES DEL C.C.) <b>A/F</b>	05-16	4	1.8		11653
COROLLA (DESPUÉS DEL C.C.)	09-16	4	1.8		11680
COROLLA (DESPUÉS DEL C.C.) S/C ALTA RESISTENCIA	03-04	4	1.8		11924
COROLLA (ANTES DEL C.C.)	03-04	4	1.8		11947
COROLLA (DESPUÉS DEL C.C.)	03-04	4	1.8		11948
HIACE (ANTES DEL C.C.) <b>A/F</b>	06-16	4	2.7		11653
HIACE (DESPUÉS DEL C.C.)	06-16	4	2.7		11946
HIGHLANDER (ANTES DEL C.C.) <b>A/F</b>	08-16	6	3.5		11647
HIGHLANDER (DESPUÉS DEL C.C.) TRAS.	08-16	6	3.5		11887
LAND CRUISER (ANTES DEL C.C.) <b>A/F</b>	07-07	8	4.7		11653
LAND CRUISER (ANTES DEL C.C.) <b>NUEVO</b>	04-05	8	4.7		11859
LAND CRUISER (ANTES DEL C.C.) <b>A/F</b>	13-16	8	5.7		11653
MATRIX (DESPUÉS DEL C.C.)	03-08	4	1.8		11649
MATRIX (ANTES DEL C.C.) <b>A/F</b>	04-10	4	1.8		11653
MATRIX (DESPUÉS DEL C.C.)	09-10	4	1.8		11680
MATRIX (DESPUÉS DEL C.C.) S/C ALTA RESISTENCIA	05-06	4	1.8		11924
PRIUS (ANTES DEL C.C.) <b>A/F</b>	10-16	4	1.8		11653
PRIUS HIBRIDO (DESPUÉS DEL C.C.)	10-16	4	1.8		11648
RAV4 (ANTES DEL C.C.) <b>A/F</b>	04-08	4	2.4		11899
RAV4 (DESPUÉS DEL C.C.)	04-05	4	2.4		11906
RAV4 (DESPUÉS DEL C.C.)	06-08	4	2.4		11946
SEQUOIA (ANTES DEL C.C.) <b>A/F</b>	10-12	8	4.6		11653
SEQUOIA (ANTES DEL C.C.) <b>A/F</b>	08-09	8	4.7	11653	
SEQUOIA (ANTES DEL C.C.) <b>A/F</b>	08-16	8	5.7	11653	
SIENNA (DESPUÉS DEL C.C.)	04-06	6	3.3	11648	
SIENNA (DESPUÉS DEL C.C.)	04-06	6	3.3	11672	
SIENNA (ANTES DEL C.C.) <b>A/F</b>	04-06	6	3.3	11899	
SIENNA (ANTES DEL C.C.) <b>A/F</b>	07-16	6	3.5	11647	
SIENNA (DESPUÉS DEL C.C.)	07-16	6	3.5	11648	
SIENNA (DESPUÉS DEL C.C.)	07-10	6	3.5	11672	
SIENNA (DESPUÉS DEL C.C.) - DERECHO	11-14	6	3.5	11878	
SOLARA (ANTES DEL C.C.) <b>A/F</b>	05-06	6	3.3	11647	
TACOMA (ANTES DEL C.C.) <b>A/F</b>	06-15	6	4.0	11653	
TUNDRA (ANTES DEL C.C.) <b>A/F</b>	07-07	6	4.0	11653	
TUNDRA (ANTES DEL C.C.) <b>A/F</b>	07-09	8	4.7	11653	
TUNDRA (ANTES DEL C.C.) <b>A/F</b>	11-14	8	5.7	11653	
YARIS (ANTES DEL C.C.) <b>A/F</b>	07-17	4	1.5	11653	

VOLKSWAGEN						
MODELO	AÑO	CIL.	MOTOR	SISTEMA	No. PARTE	
BEETLE (ANTES DEL C.C.)	99-03	4	2.0	MPFI	11980	
BEETLE (DESPUÉS DEL C.C.)	99-03	4	2.0		11984	
BEETLE TURBO (ANTES DEL C.C.) <b>5 CAB.</b>	99-02	4	1.8		11974	
BEETLE TURBO (DESPUÉS DEL C.C.)	12-16	4	2.0		11912	
BEETLE TURBO (ANTES DEL C.C.) <b>S/C 5 CAB.</b>	99-02	4	1.8		11501	
BEETLE TURBO (DESPUÉS DEL C.C.)	99-02	4	1.8		11984	
BORA (ANTES DEL C.C.) <b>S/C 5 CAB.</b>	06-10	5	2.5		11501	
BORA (DESPUÉS DEL C.C.)	06-10	5	2.5		11911	
BORA (ANTES DEL C.C.) <b>A/F 5 CAB.</b>	06-10	5	2.5		11913	
BORA GLI (DESPUÉS DEL C.C.)	06-10	4	2.0		11912	
DERBY (ANTES DEL C.C.)	95-97	4	1.8		TBI	11982
DERBY (ANTES DEL C.C.)	98-09	4	1.8		MPFI	11989
DERBY (ANTES DEL C.C.)	01-03	4	2.0	11989		
EUROVAN (DESPUÉS DEL C.C.)	01-04	5	2.5	11984		
EUROVAN (ANTES DEL C.C.)	01-04	5	2.5	11988		
EUROVAN VR6 (ANTES DEL C.C.) <b>5 CAB.</b>	01-04	6	2.8	11975		
EUROVAN VR6 (ANTES DEL C.C.) <b>S/C 5 CAB.</b>	01-04	6	2.8	11501		
EUROVAN VR6 (DESPUÉS DEL C.C.)	01-04	6	2.8	11984		
GOL (ANTES DEL C.C.)	09-17	4	1.6	11980		
GOL (DESPUÉS DEL C.C.)	09-17	4	1.6	11984		
GOLF A2 (ANTES DEL C.C.)	90-92	4	1.8	11988		
GOLF A3 (ANTES DEL C.C.)	93-94	4	1.8	TBI		11982
GOLF A3 (ANTES DEL C.C.)	93-98	4	1.8	MPFI		11989
GOLF A3 (ANTES DEL C.C.)	93-98	4	2.0		11989	

CONTINÚA»

# SENSORES DE OXÍGENO

**A/F** (AIR FUEL RATIO SENSOR)

**S/C** (SIN CONECTOR)

**5 CAB.** (5 CABLES)

VOLKSWAGEN					
MODELO	AÑO	CIL.	MOTOR	SISTEMA	No. PARTE
GOLF A4 (ANTES DEL C.C.)	00-03	4	2.0	MPFI	11980
GOLF A4 (DESPUÉS DEL C.C.)	00-03	4	2.0		11984
GOLF A5 GTI (DESPUÉS DEL C.C.)	07-09	4	2.0		11912
JETTA A2 (ANTES DEL C.C.)	90-92	4	1.8	TBI	11988
JETTA A3 (ANTES DEL C.C.)	93-94	4	1.8		11982
JETTA A3 (ANTES DEL C.C.)	93-99	4	1.8	MPFI	11989
JETTA A3 (ANTES DEL C.C.)	93-99	4	2.0		11989
JETTA A3 VR6 (DESPUÉS DEL C.C.)	96-98	6	2.8		11985
JETTA A3 VR6 (ANTES DEL C.C.)	96-98	6	2.8		11990
JETTA A4 (ANTES DEL C.C.)	99-10	4	2.0		11980
JETTA A4 (DESPUÉS DEL C.C.)	99-10	4	2.0		11984
JETTA A4 CLASICO (ANTES DEL C.C.)	10-15	4	2.0		11980
JETTA A4 CLASICO (DESPUÉS DEL C.C.)	10-15	4	2.0		11984
JETTA A4 TURBO (ANTES DEL C.C.) 5 CAB.	99-05	4	1.8		11974
JETTA A4 TURBO (DESPUÉS DEL C.C.)	99-05	4	1.8		11984
JETTA A4 VR6 (ANTES DEL C.C.) 5 CAB.	99-02	6	2.8		11975
JETTA A4 VR6 (DESPUÉS DEL C.C.)	99-02	6	2.8		11984
JETTA A4 VR6 (ANTES DEL C.C.) S/C 5 CAB.	99-02	6	2.8		11501
JETTA A6 (DESPUÉS DEL C.C.)	13-16	4	2.0		11912
JETTA A6 (ANTES DEL C.C.) A/F 5 CAB.	13-16	4	2.0		11913
JETTA A6 (DESPUÉS DEL C.C.)	11-16	5	2.5		11912
JETTA A6 (ANTES DEL C.C.) A/F 5 CAB.	11-16	5	2.5		11913
JETTA A6 GLI (DESPUÉS DEL C.C.)	12-16	4	2.0		11912
PASSAT TURBO (ANTES DEL C.C.) 5 CAB.	99-02	4	1.8		11974
PASSAT TURBO (ANTES DEL C.C.) S/C 5 CAB.	99-02	4	1.8		11501
PASSAT TURBO (DESPUÉS DEL C.C.)	99-02	4	1.8	11984	
PASSAT VR6 (DESPUÉS DEL C.C.)	98-99	6	2.8	11920	
PASSAT VR6 (DESPUÉS DEL C.C.)	00-02	6	2.8	11984	
POINTER (DESPUÉS DEL C.C.)	04-09	4	1.8	11980	
POINTER (ANTES DEL C.C.)	98-03	4	1.8	11981	
POINTER (ANTES DEL C.C.)	04-09	4	1.8	11984	
POINTER GTI (ANTES DEL C.C.)	00-02	4	2.0	11981	
POINTER GTI (ANTES DEL C.C.)	03-03	4	2.0	11980	
POINTER GTI (DESPUÉS DEL C.C.)	00-03	4	2.0	11980	
POINTER PICK UP (ANTES DEL C.C.)	99-02	4	1.8	11981	
POLO (ANTES DEL C.C.)	03-07	4	1.6	11980	
POLO (DESPUÉS DEL C.C.)	03-07	4	1.6	11984	
ROUTAN (ANTES DEL C.C.) <b>NUEVO</b>	09-10	6	3.8	11865	
SEDAN (ANTES DEL C.C.) S/C	93-96	4	1.6	11014	
SEDAN (ANTES DEL C.C.)	00-04	4	1.6	11981	
SEDAN (ANTES DEL C.C.)	93-96	4	1.6	11987	
SEDAN (ANTES DEL C.C.)	97-99	4	1.6	11990	
VENTO (ANTES DEL C.C.)	14-17	4	1.6	11651	
VENTO (DESPUÉS DEL C.C.)	14-17	4	1.6	11652	

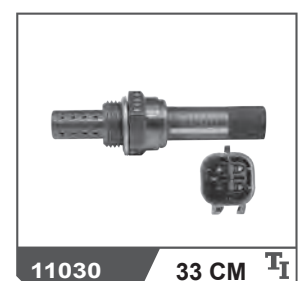
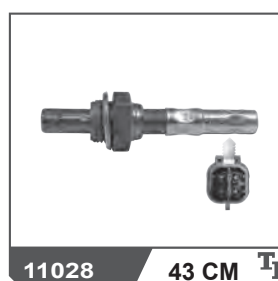
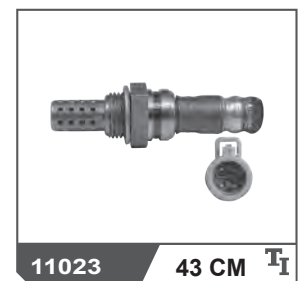
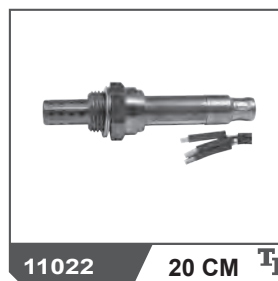
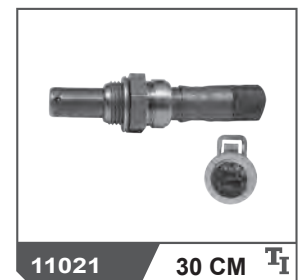
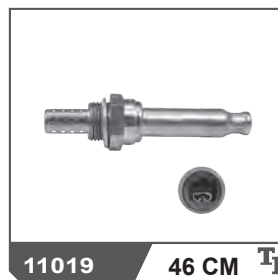
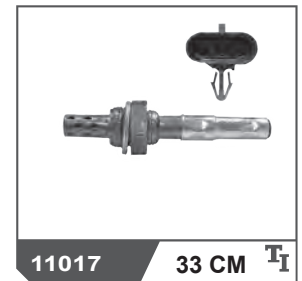
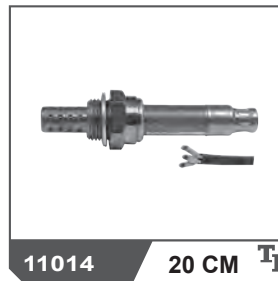
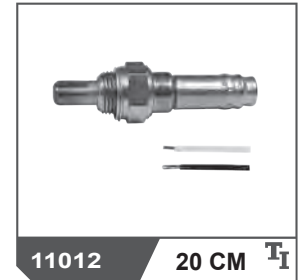
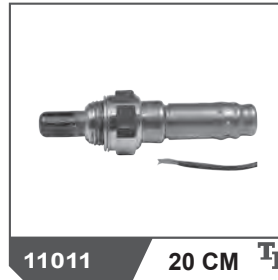
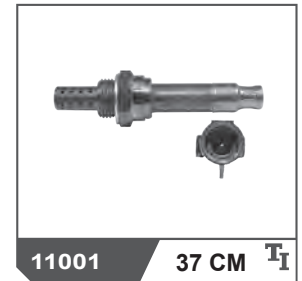
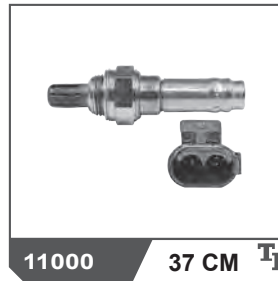

**SENSORES DE OXÍGENO**



**11047**    **61 CM** <sup>TI</sup>



**11058**    **61 CM** <sup>TI</sup>

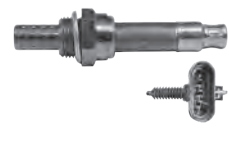

**11066**    **34 CM** <sup>TI</sup>



**11089**    **66 CM** <sup>TI</sup>



**11091**    **38 CM** <sup>TI</sup>



**11097**    **30 CM** <sup>TI</sup>

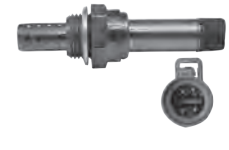

**11098**    **42 CM** <sup>TI</sup>



**11139**    **30 CM** <sup>TI</sup>



**11143**    **59 CM** <sup>TI</sup>

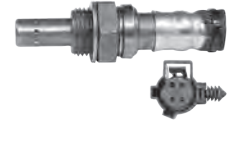

**11144**    **33 CM** <sup>TI</sup>



**11151**    **48 CM** <sup>TI</sup>



**11157**    **46 CM** <sup>TI</sup>



**11158**    **46 CM** <sup>TI</sup>



**11159**    **33 CM** <sup>TI</sup>



**11160**    **92 CM** <sup>TI</sup>



**11161**    **48 CM** <sup>TI</sup>



**11170**    **35 CM** <sup>TI</sup>

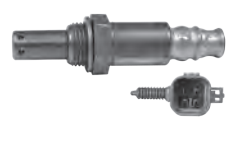

**11172**    **35 CM** <sup>TI</sup>



**11173**    **40 CM** <sup>TI</sup>



**11209**    **32 CM** <sup>TI</sup>



**11210**    **48 CM** <sup>TI</sup>

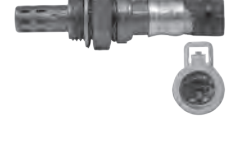

**11217**    **54 CM** <sup>TI</sup>



**11220**    **33 CM** <sup>TI</sup>



**11221**    **64 CM** <sup>TI</sup>

# SENSORES DE OXÍGENO

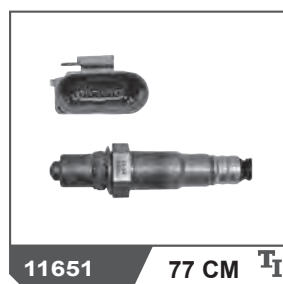
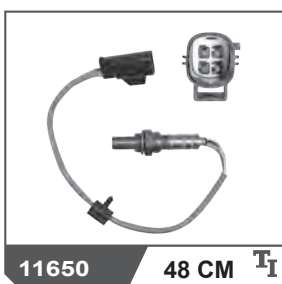
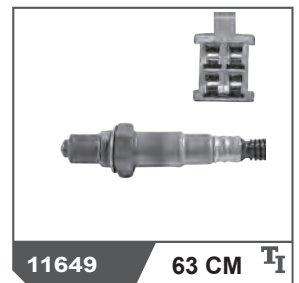
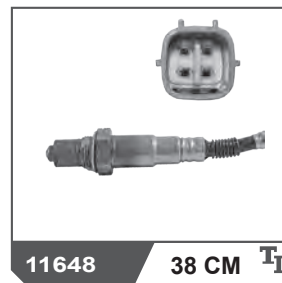
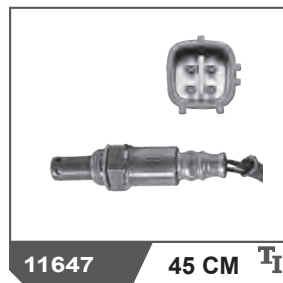
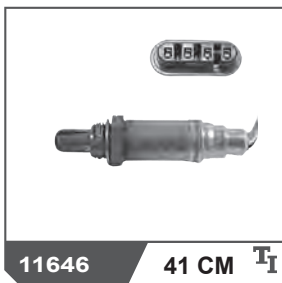
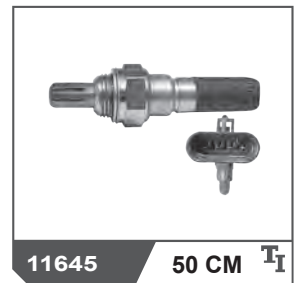
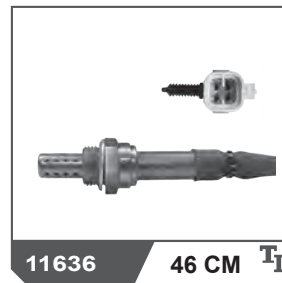
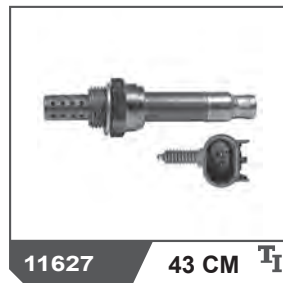
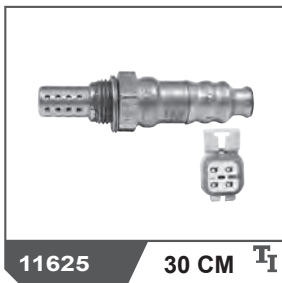
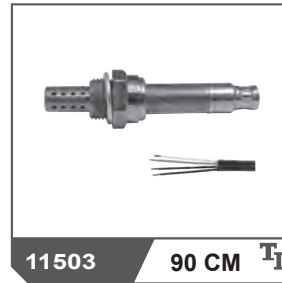
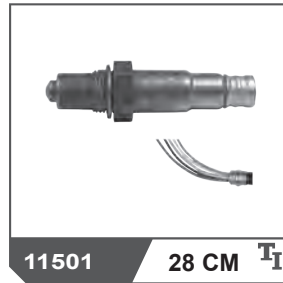
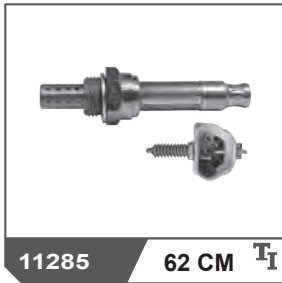
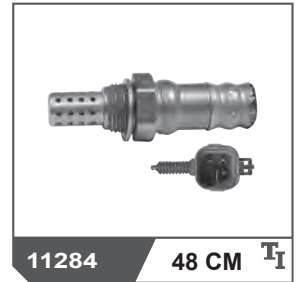
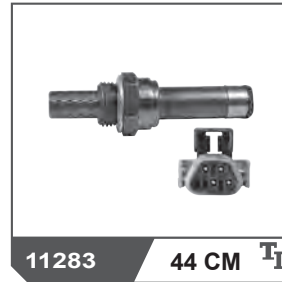
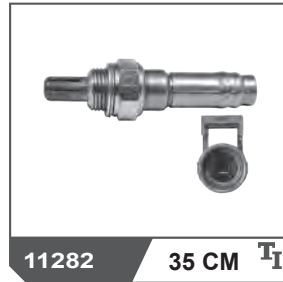
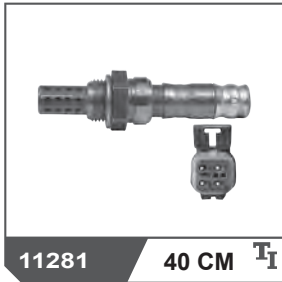
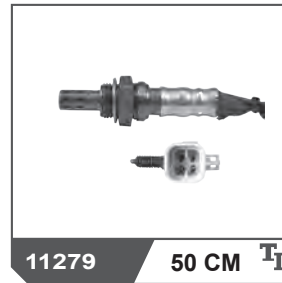
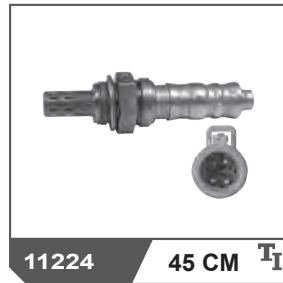
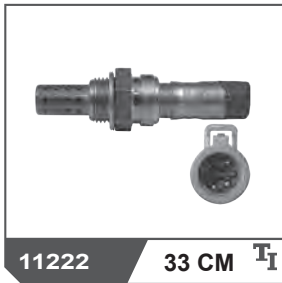

**SENSORES DE OXÍGENO**



11654 112 CM <sup>TI</sup>

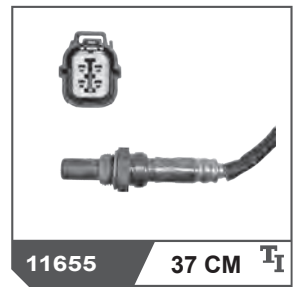

11655 37 CM <sup>TI</sup>



11656 113 CM <sup>TI</sup>

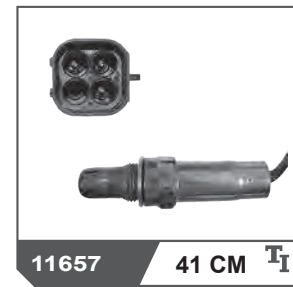

11657 41 CM <sup>TI</sup>



11659 85 CM <sup>TI</sup>

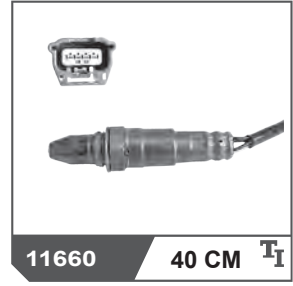

11660 40 CM <sup>TI</sup>

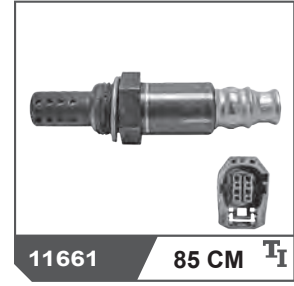

11661 85 CM <sup>TI</sup>

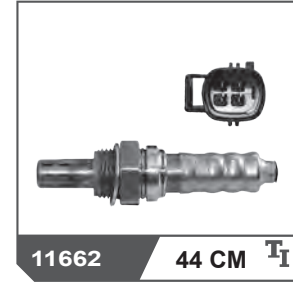

11662 44 CM <sup>TI</sup>

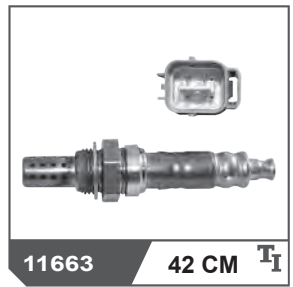

11663 42 CM <sup>TI</sup>



11665 49 CM <sup>TI</sup>

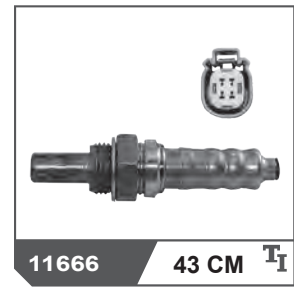

11666 43 CM <sup>TI</sup>

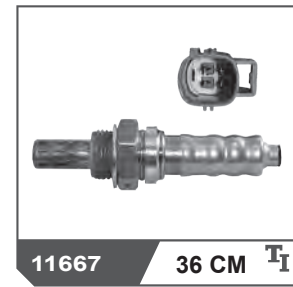

11667 36 CM <sup>TI</sup>



11668 76 CM <sup>TI</sup>

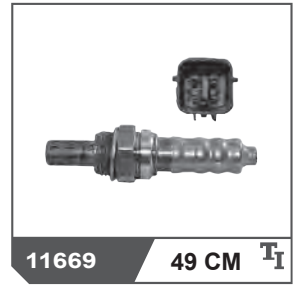

11669 49 CM <sup>TI</sup>

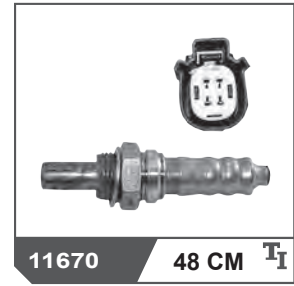

11670 48 CM <sup>TI</sup>

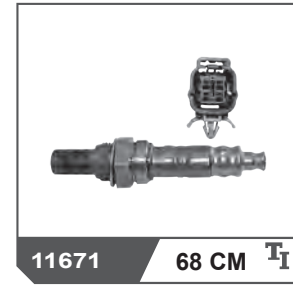

11671 68 CM <sup>TI</sup>



11672 56 CM <sup>TI</sup>

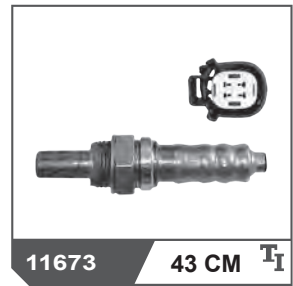

11673 43 CM <sup>TI</sup>



11674 48 CM <sup>TI</sup>

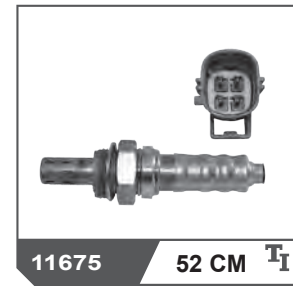

11675 52 CM <sup>TI</sup>



11676 57 CM <sup>TI</sup>



11677 60 CM <sup>TI</sup>

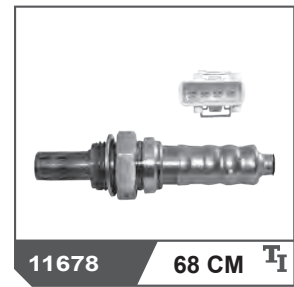

11678 68 CM <sup>TI</sup>

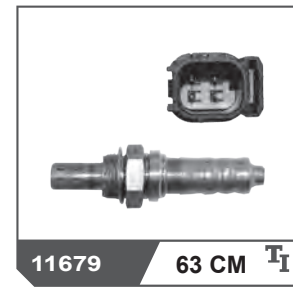

11679 63 CM <sup>TI</sup>



# SENSORES DE OXÍGENO

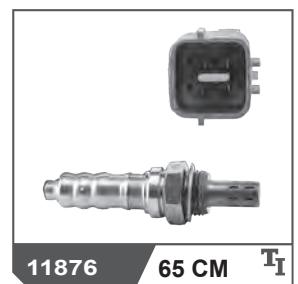
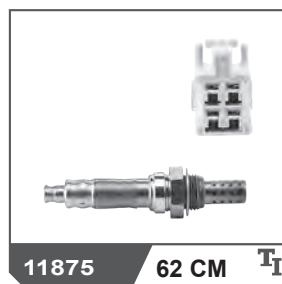
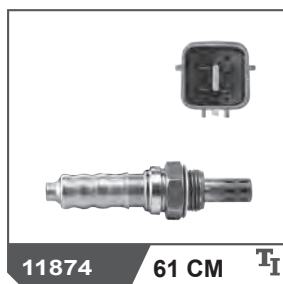
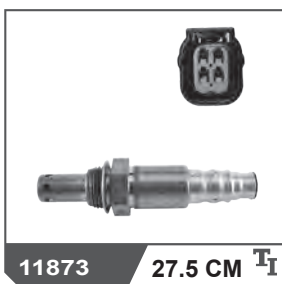
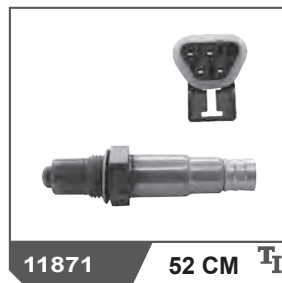
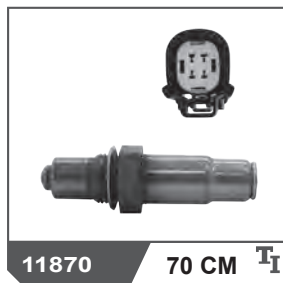
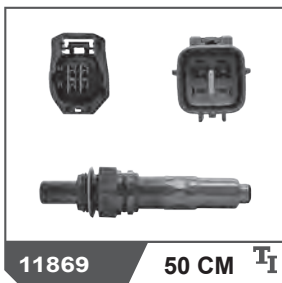
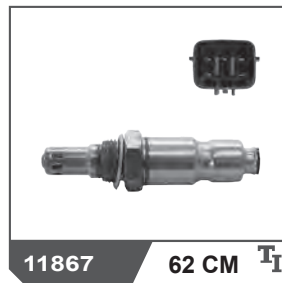
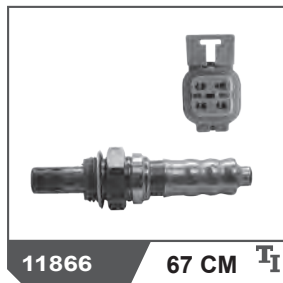
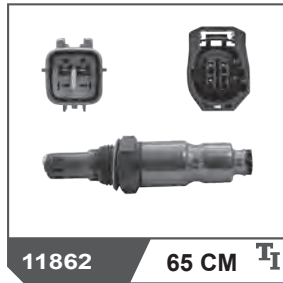
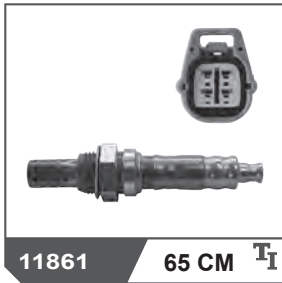
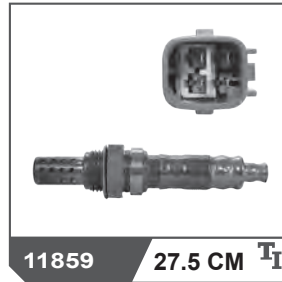
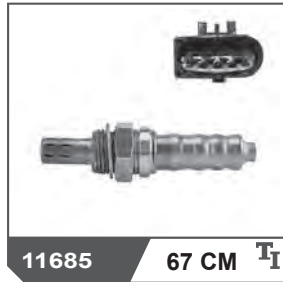
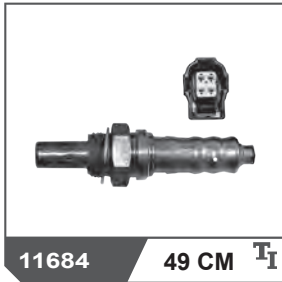
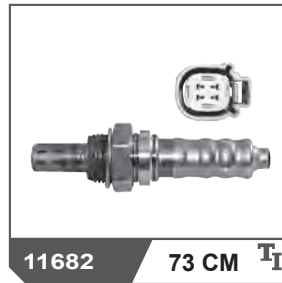
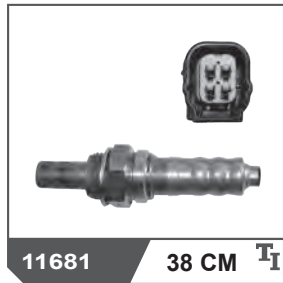
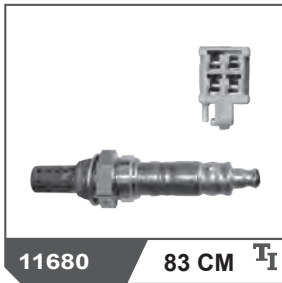

**SENSORES DE OXÍGENO**

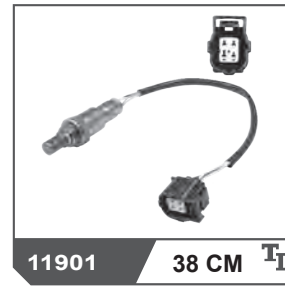
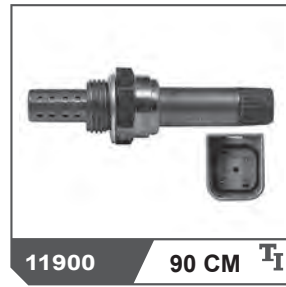
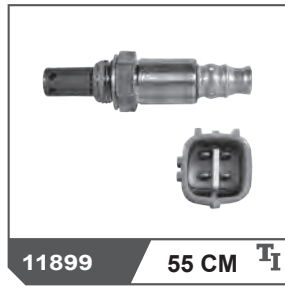
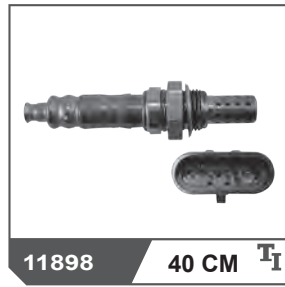
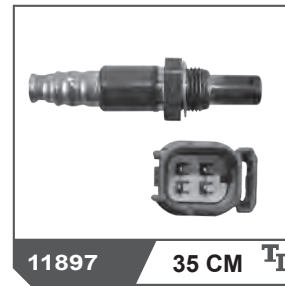
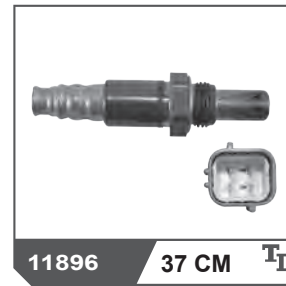
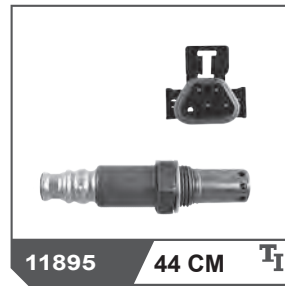
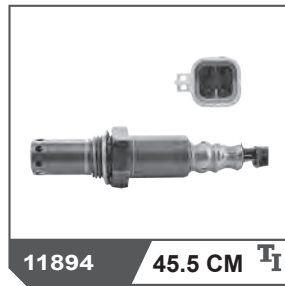
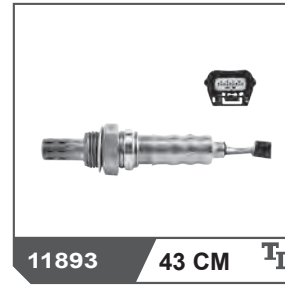
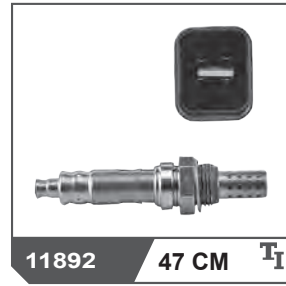
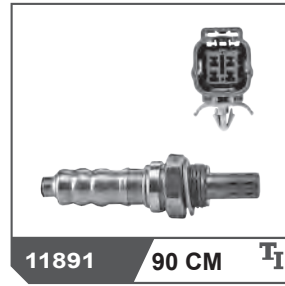
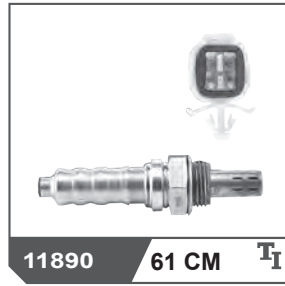
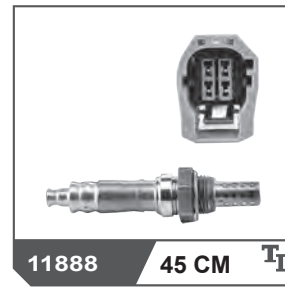
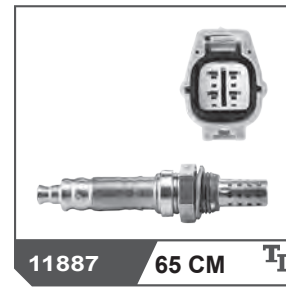
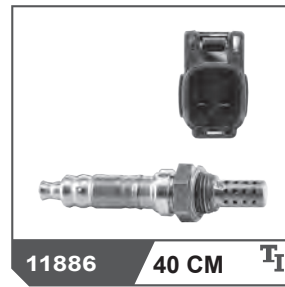
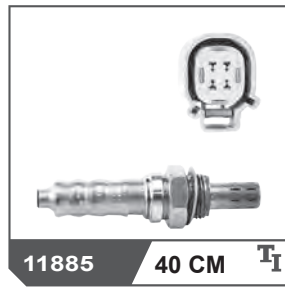
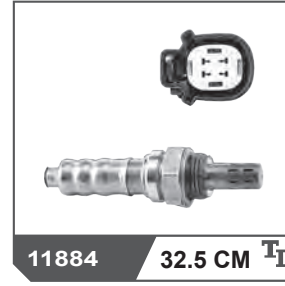
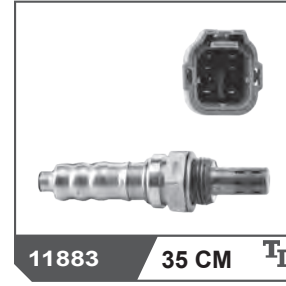
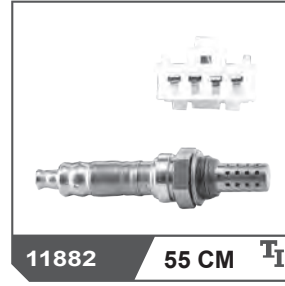
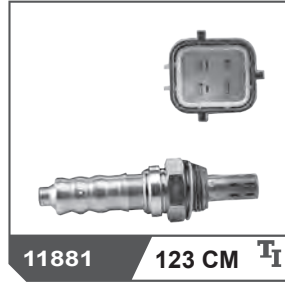
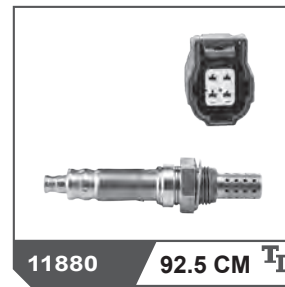
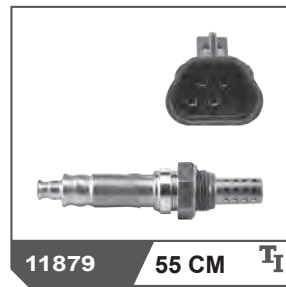
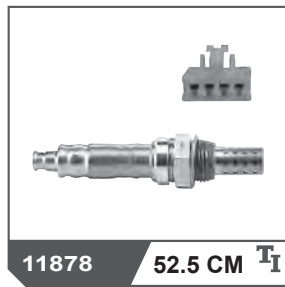
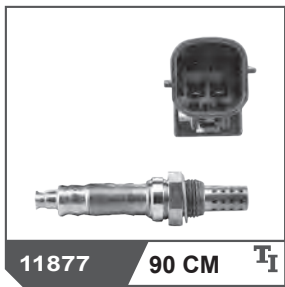

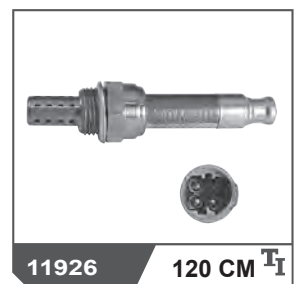
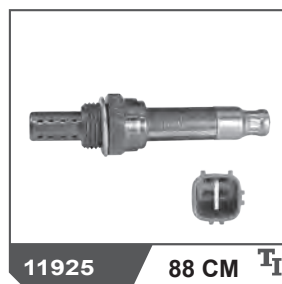
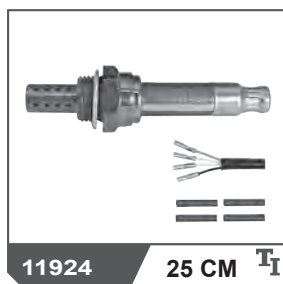
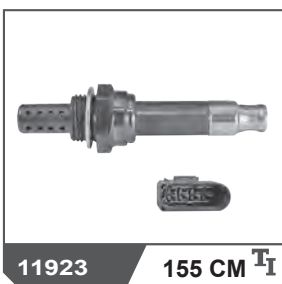
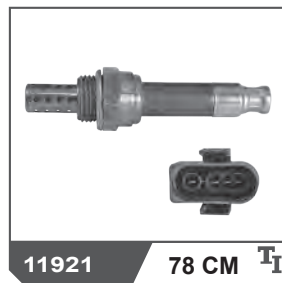
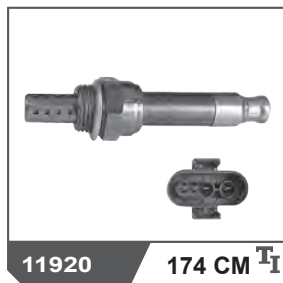
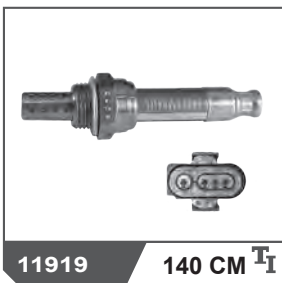
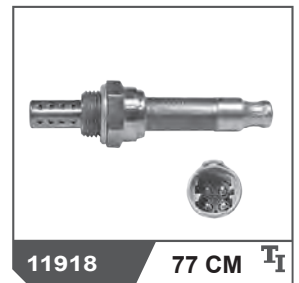
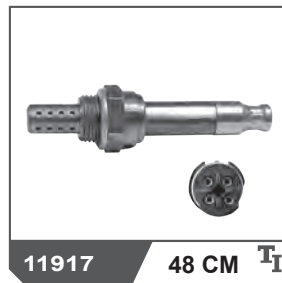
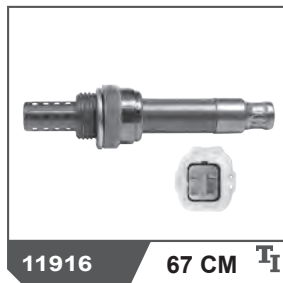
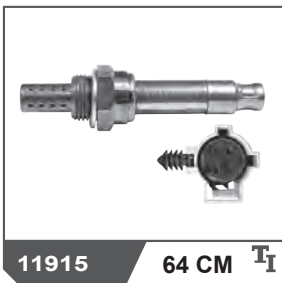
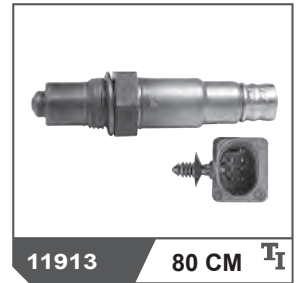
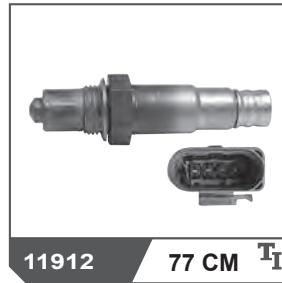
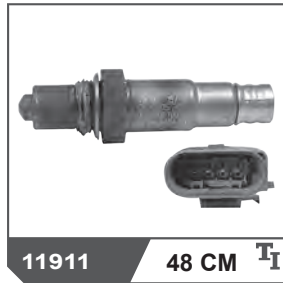
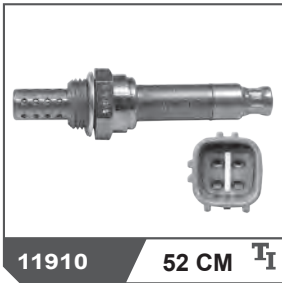
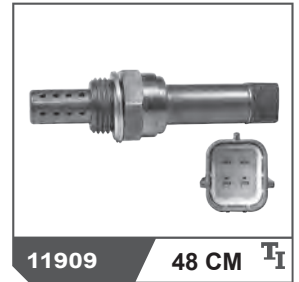
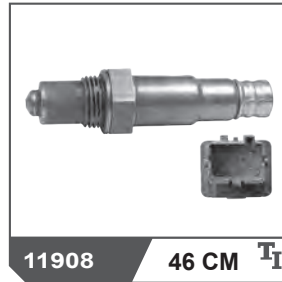
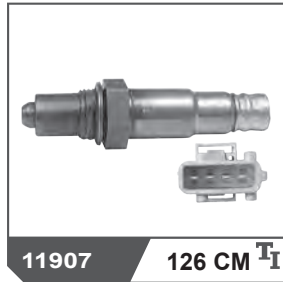
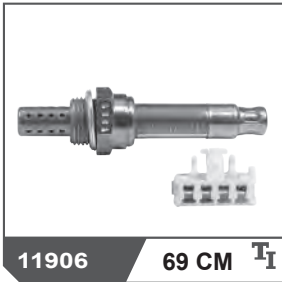
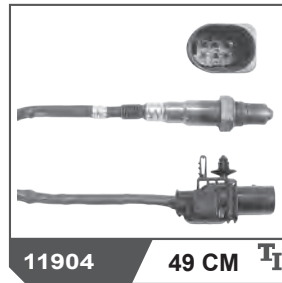
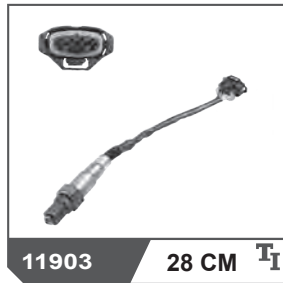
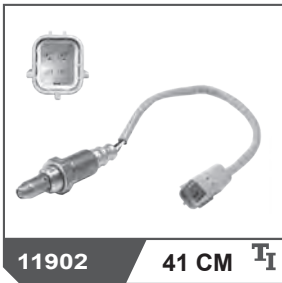

**SENSORES DE OXÍGENO**



**11936**    **73 CM** **T<sub>I</sub>**



**11937**    **68 CM** **T<sub>I</sub>**



**11938**    **35 CM** **T<sub>I</sub>**

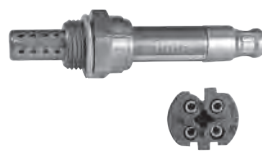

**11939**    **35 CM** **T<sub>I</sub>**



**11940**    **70 CM** **T<sub>I</sub>**

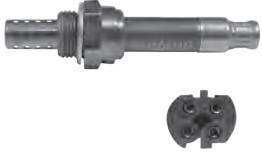

**11941**    **46 CM** **T<sub>I</sub>**



**11942**    **85 CM** **T<sub>I</sub>**

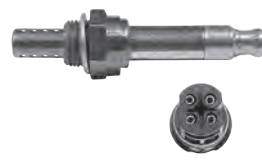

**11943**    **41 CM** **T<sub>I</sub>**



**11945**    **120 CM** **T<sub>I</sub>**

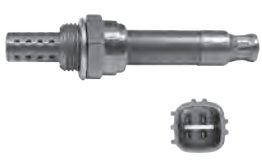

**11946**    **39 CM** **T<sub>I</sub>**

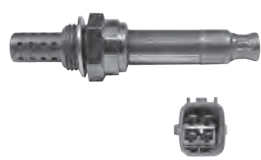

**11947**    **52 CM** **T<sub>I</sub>**



**11948**    **57 CM** **T<sub>I</sub>**

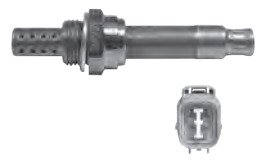

**11949**    **53 CM** **T<sub>I</sub>**

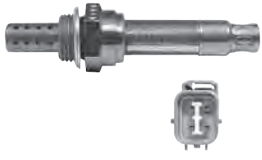

**11950**    **61 CM** **T<sub>I</sub>**

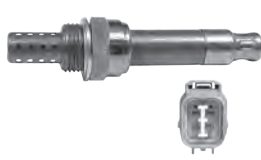

**11951**    **46 CM** **T<sub>I</sub>**



**11952**    **90 CM** **T<sub>I</sub>**



**11953**    **55 CM** **T<sub>I</sub>**

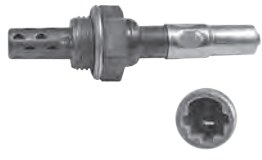

**11954**    **54 CM** **T<sub>I</sub>**



**11955**    **46 CM** **T<sub>I</sub>**



**11956**    **85 CM** **T<sub>I</sub>**



**11957**    **40 CM** **T<sub>I</sub>**



**11958**    **47 CM** **T<sub>I</sub>**

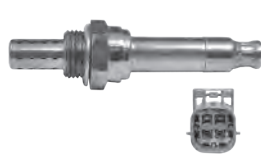

**11959**    **43 CM** **T<sub>I</sub>**



**11960**    **34 CM** **T<sub>I</sub>**

# SENSORES DE OXÍGENO

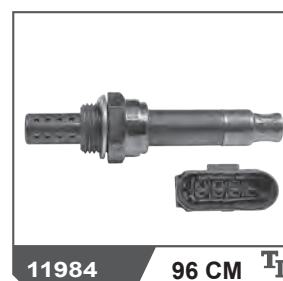
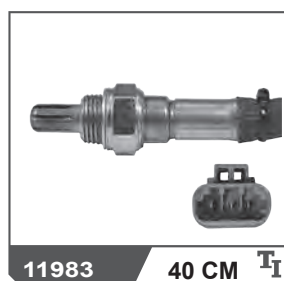
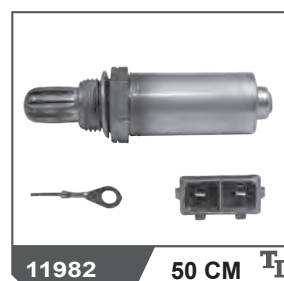
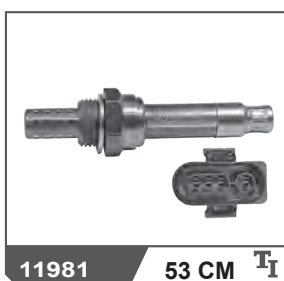
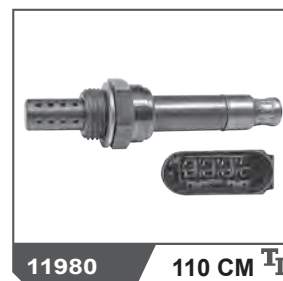
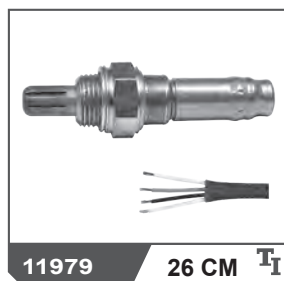
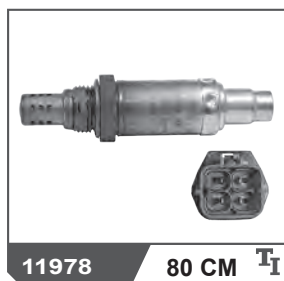
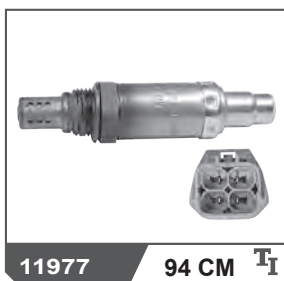
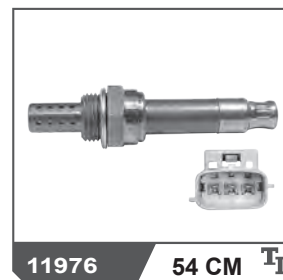
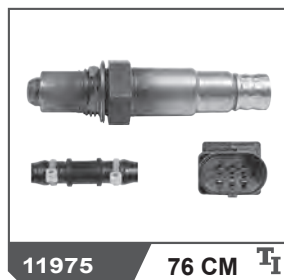
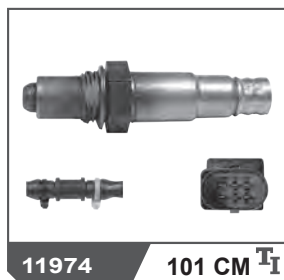
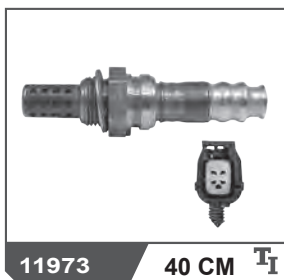
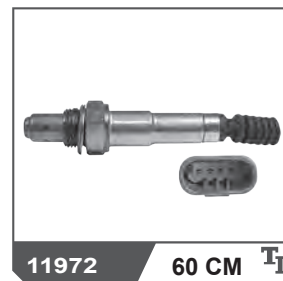
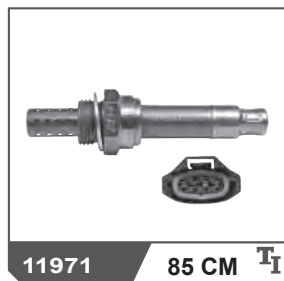
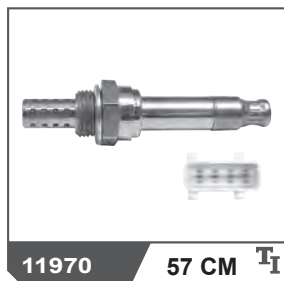
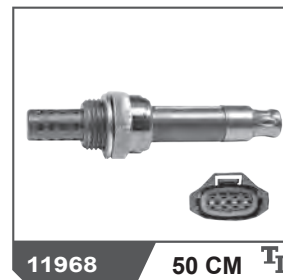
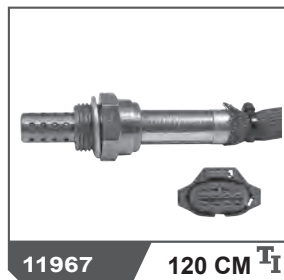
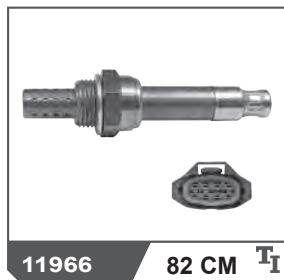
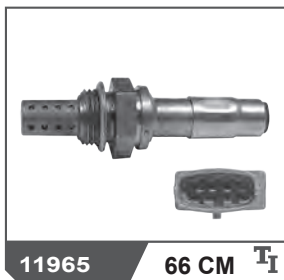
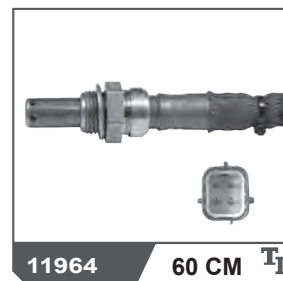
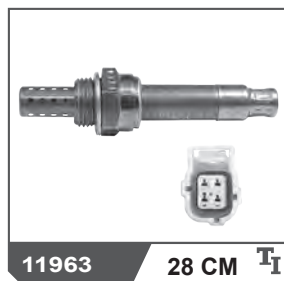
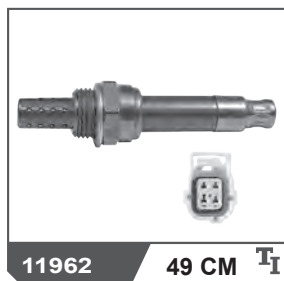
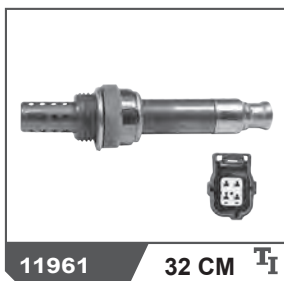



**SENSORES DE OXÍGENO**



**11985**    **117 CM** <sup>TI</sup>



**11986**    **66 CM** <sup>TI</sup>



**11987**    **70 CM** <sup>TI</sup>

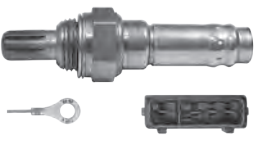

**11988**    **61 CM** <sup>TI</sup>



**11989**    **65 CM** <sup>TI</sup>



**11990**    **172 CM** <sup>TI</sup>



**11991**    **25 CM** <sup>TI</sup>



**11992**    **40 CM** <sup>TI</sup>

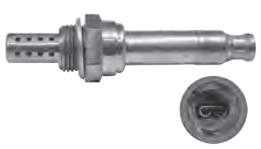

**11993**    **22 CM** <sup>TI</sup>



**11994**    **49 CM** <sup>TI</sup>



**11995**    **47 CM** <sup>TI</sup>



**11996**    **60 CM** <sup>TI</sup>



**11997**    **33 CM** <sup>TI</sup>



**11998**    **30 CM** <sup>TI</sup>



**11999**    **43 CM** <sup>TI</sup>

NISSAN					
MODELO	AÑO	CIL.	MOTOR	SISTEMA	No. PARTE
TSURU III GSR 2000	94-96	4	2.0	MPFI	10694



**VÁLVULAS DE CONTROL DE AIRE EN MARCHA MÍNIMA (IAC)**

**SU FUNCIÓN:**

Ajustar el flujo de masa de aire en el circuito de marcha mínima para mantener la velocidad en diversas condiciones de carga en vehículos de inyección de combustible.

**SÍNTOMAS DE FALLA:**

El vehículo se detiene, velocidad mínima, alta o baja, la luz de "chechar motor" se enciende continuamente.

**MANTENIMIENTO/SERVICIO:**

Checar si hay carbón en la punta y limpiar cada 40,000 kms. Reemplazar de acuerdo a las especificaciones del fabricante.

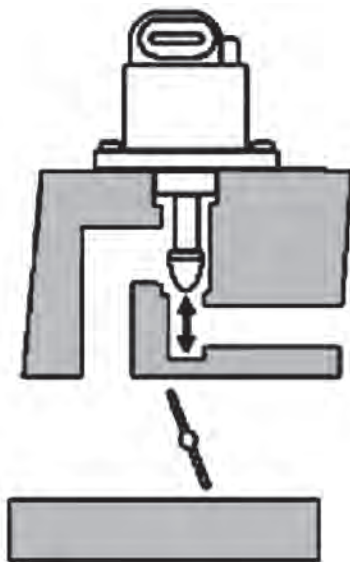

CHRYSLER					
MODELO	AÑO	CIL.	MOTOR	SISTEMA	No. PARTE
300M	99-99	6	3.5	MPFI	8433
300M	02-04	6	3.5		84990
CIRRUS	96-97	4	2.4		8466
CIRRUS	96-00	6	2.5		8468
CIRRUS	01-02	4	2.4		84995
CONCORDE	93-97	6	3.5		8469
CONCORDE	02-02	6	3.5		84990
GRAND VOYAGER	98-99	6	3.8		8433
GRAND VOYAGER	97-97	6	3.8		8468
GRAND VOYAGER	91-93	6	3.3		8469
GRAND VOYAGER	94-96	6	3.8		8469
GRAND VOYAGER	01-02	6	3.8		84990

CHRYSLER					
MODELO	AÑO	CIL.	MOTOR	SISTEMA	No. PARTE
LEBARON K	87-87	4	2.2	MPFI	8466
LEBARON TURBO	92-94	4	2.5		8466
NEW YORKER K	87-88	4	2.2		8466
NEW YORKER LH	94-96	6	3.5		8469
NEW YORKER TURBO	91-94	4	2.5		8466
PACIFICA	04-06	6	3.5		84990
PHANTOM TURBO	89-89	4	2.2		8466
PHANTOM TURBO	90-94	4	2.5		8466
PT CRUISER	01-02	4	2.4		84995
TOWN & COUNTRY	98-00	6	3.8		8433
TOWN & COUNTRY	97-97	6	3.8		8468
TOWN & COUNTRY	93-93	6	3.3		8469
TOWN & COUNTRY	94-96	6	3.8		8469
TOWN & COUNTRY	01-07	6	3.8		84990
VOYAGER	00-00	6	3.3		8433
VOYAGER	97-99	6	3.3		8468
VOYAGER	95-95	6	3.3		8469
VOYAGER	01-06	6	3.3		84990

CHRYSLER DODGE					
MODELO	AÑO	CIL.	MOTOR	SISTEMA	No. PARTE
ATOS	01-04	4	1.0	MPFI	84998
ATOS	05-12	4	1.1		84998
ATTITUDE	06-11	4	1.6		84974
ATTITUDE	06-11	4	1.4		84974
DAKOTA	05-07	6	3.7		84977
DAKOTA	07-07	8	4.7		84977
DURANGO	98-00	8	5.2		8420
DURANGO	98-03	8	5.9		8420
DURANGO	04-06	8	5.7		84977
DURANGO	02-09	8	4.7		84977
DURANGO	00-02	8	4.7		84981
H100 VAN	12-14	4	2.4		84955
i10	12-14	4	1.1		84959
INTREPID	98-99	6	3.2		8433
INTREPID	94-97	6	3.5		8469
INTREPID	01-02	6	3.5		84990
MAGNUM K	87-88	4	2.2		8466
MICROBUS	91-94	8	5.9		TBI
NEON	95-97	4	2.0	MPFI	8417
NEON	95-97	4	2.0		8434
NEON	95-99	4	2.0		8464
NEON	01-04	4	2.0		84997
NEON	01-04	4	2.0		84997
RAM 1500	94-99	6	3.9		8420
RAM 1500	00-02	6	3.9		8421
RAM 1500	04-07	6	3.7		84977
RAM 1500	02-03	6	3.7		84981
RAM 2500	94-02	8	5.9		8420

CONTINÚA»

CHRYSLER		DODGE				
MODELO	AÑO	CIL.	MOTOR	SISTEMA	No. PARTE	
RAM 2500	94-96	8	5.2	MPFI	8420	
RAM 2500	03-06	8	4.7		84977	
RAM 2500	05-05	8	5.7		84977	
RAM 3500	94-02	8	5.9		8420	
RAM 4000	94-02	8	5.9		8420	
RAM VAN 2500	98-02	8	5.2		8420	
RAM VAN 3500	99-02	8	5.9		8420	
RAMCHARGER	99-01	8	5.9		8420	
RAMCHARGER	91-94	8	5.9		TBI	8425
SHADOW	91-94	4	2.5		MPFI	8466
SHADOW GTS	89-90	4	2.2	8466		
SPIRIT	91-94	4	2.5	8466		
STRATUS	95-97	4	2.0	8417		
STRATUS	98-00	4	2.0	8464		
STRATUS	95-96	4	2.4	8466		
STRATUS	03-06	4	2.4	84990		
STRATUS	01-06	4	2.0	84995		
STRATUS	01-02	4	2.4	84995		
VERNA	04-06	4	1.5	84974		
VERNA	04-06	4	1.6	84998		

CHRYSLER		JEEP			
MODELO	AÑO	CIL.	MOTOR	SISTEMA	No. PARTE
CHEROKEE SPORT	94-94	6	4.0	MPFI	8430
CHEROKEE SPORT	98-01	6	4.0		8432
COMMANDER	06-07	8	4.7		84977
GRAND CHEROKEE	93-98	8	5.2		8420
GRAND CHEROKEE	98-98	8	5.9		8420
GRAND CHEROKEE	93-97	6	4.0		8430
GRAND CHEROKEE	98-04	6	4.0		8432
GRAND CHEROKEE	05-06	6	3.7		84977
GRAND CHEROKEE	05-07	8	4.7		84977
GRAND CHEROKEE	99-04	8	4.7		84981
LIBERTY	04-07	6	3.7	84977	
LIBERTY	02-03	6	3.7	84981	
WRANGLER	99-02	4	2.5	8432	
WRANGLER	98-04	6	4.0	8432	
WRANGLER	93-97	4	2.5	8459	
WRANGLER	05-06	6	4.0	84977	
WRANGLER	05-06	4	2.4	84990	
WRANGLER	03-04	4	2.4	84995	

FORD					
MODELO	AÑO	CIL.	MOTOR	SISTEMA	No. PARTE
AEROSTAR	95-95	6	4.0	MPFI	8490
AEROSTAR	92-95	6	3.0		84958
AEROSTAR	93-94	6	4.0		84970
CONTOUR	96-00	6	2.5		8473
CONTOUR	96-96	4	2.0		84954
CONTOUR	95-95	4	2.0		84971
CONTOUR	97-00	4	2.0		84984
COURIER	01-06	4	1.6		8422
COURIER	07-09	4	1.6		84957
ECONOLINE E-150	01-03	6	4.2		84949
ECONOLINE E-150	95-95	6	4.9	84969	
ECONOLINE E-150	04-04	8	4.6	84982	
ECONOLINE E-150	97-00	6	4.2	84992	
ECONOLINE E-250	01-02	6	4.2	84949	
ECONOLINE E-250	97-00	6	4.2	84992	
ECONOLINE E-350	97-03	8	5.4	8404	
ECOSPORT	04-05	4	2.0	84950	
ECOSPORT	06-07	4	2.0	84980	
ESCAPE	03-04	6	3.0	84953	
ESCAPE	04-08	6	3.0	84980	
ESCAPE	05-08	4	2.3	84980	
ESCORT	94-95	4	1.9	8415	

FORD					
MODELO	AÑO	CIL.	MOTOR	SISTEMA	No. PARTE
ESCORT	98-99	4	2.0	MPFI	8473
ESCORT	96-96	4	1.9		8474
ESCORT	98-01	4	2.0		84984
EXPEDITION	98-00	8	4.6		8471
EXPEDITION	97-97	8	4.6		8473
EXPEDITION	02-04	8	4.6		84982
EXPLORER	97-97	8	5.0		8416
EXPLORER	96-01	8	5.0		8471
EXPLORER	98-00	6	4.0		8471
EXPLORER	95-97	6	4.0		8481
EXPLORER	95-96	6	4.0	84956	
EXPLORER	99-01	6	4.0	84968	
EXPLORER	91-94	6	4.0	84970	
EXPLORER 2 PUERTAS	02-03	6	4.0	84975	
EXPLORER 4 PUERTAS	02-10	6	4.0	84985	
F-150	92-94	6	3.8	8419	
F-150	97-01	8	4.6	8471	
F-150	01-08	6	4.2	84949	
F-150	96-96	6	4.9	8495	
F-150	02-03	8	4.6	84982	
F-150	97-00	6	4.2	84992	
F-250	94-96	8	5.0	8418	
F-250	94-97	8	5.8	8418	
F-250	97-99	8	4.6	8471	
F-250	02-04	8	4.6	84987	
F-250	99-99	8	4.6	84992	
F-350	00-03	8	5.4	8404	
F-350	95-95	8	5.0	8418	
F-350	94-97	8	5.8	8418	
F-350	92-92	8	5.0	8490	
F-350 SUPER DUTY	99-04	8	5.4	8404	
FIESTA	02-09	4	1.6	8422	
FIESTA	10-11	4	1.6	84957	
FIESTA	98-01	4	1.3	84986	
FOCUS	05-07	4	2.0	84950	
FOCUS	00-04	4	2.0	84986	
FOCUS	00-04	4	2.0	84992	
FOCUS ST	07-07	5	2.5	84950	
FREESTAR	04-07	6	4.2	84985	
GHIA	93-94	6	3.0	8418	
GHIA	91-91	4	2.3	8490	
IKON	01-03	4	1.6	8422	
KA	01-03	4	1.6	8422	
LOBO	04-06	8	4.6	84982	
MICROBUS	92-92	8	5.0	8490	
MONDEO	01-05	4	2.0	84950	
MONDEO	01-07	6	2.5	84987	
MUSTANG	94-95	8	5.0	8409	
MUSTANG	01-01	8	4.6	8481	
MUSTANG	96-00	8	4.6	8493	
MUSTANG	02-03	8	4.6	84966	
RANGER	99-02	6	3.0	8471	
RANGER	95-97	4	2.3	8481	
RANGER	01-11	4	2.3	84950	
TAURUS	89-91	6	3.8	8409	
TAURUS	88-88	6	3.8	8490	
THUNDERBIRD	91-93	8	5.0	8409	
THUNDERBIRD	95-95	8	4.6	8416	
THUNDERBIRD	96-96	8	4.6	8493	
THUNDERBIRD	96-96	6	3.8	84992	
THUNDERBIRD SC	89-95	6	3.8	8409	
WINDSTAR	96-98	6	3.8	8495	
WINDSTAR	95-95	6	3.8	84969	
WINDSTAR	01-03	6	3.8	84988	

FORD		LINCOLN			
MODELO	AÑO	CIL.	MOTOR	SISTEMA	No. PARTE
LS	00-02	8	3.9	MPFI	84965
MARK VIII	96-96	8	4.6		8473
TOWN CAR	91-95	8	4.6		8416
TOWN CAR	96-02	8	4.6		8493
TOWN CAR	03-05	8	4.6		84972

FORD		MERCURY			
MODELO	AÑO	CIL.	MOTOR	SISTEMA	No. PARTE
COUGAR XR7	90-93	6	3.8	MPFI	8409
COUGAR XR7	88-88	6	3.8		8478
COUGAR XR7	90-94	6	3.8		8478
GRAND MARQUIS	92-95	8	4.6		8416
GRAND MARQUIS	96-02	8	4.6		8493
GRAND MARQUIS	03-04	8	4.6		84972
MARINER	05-08	6	3.0		84980
MYSTIQUE	96-00	6	2.5		8473
MYSTIQUE	95-95	6	2.5		8481
MYSTIQUE	96-96	4	2.0		84954
MYSTIQUE	95-95	4	2.0		84971
MYSTIQUE	97-00	4	2.0		84984
SABLE	97-99	6	3.0		8471
SABLE	96-96	6	3.0		8476
SABLE	94-95	6	3.8		84969
SABLE DOHC	04-04	6	3.0		84980
TOPAZ	92-94	4	2.3		8419
TOPAZ	89-91	4	2.3		8490

FORD		BUICK			
MODELO	AÑO	CIL.	MOTOR	SISTEMA	No. PARTE
CENTURY	87-89	6	2.8	MPFI	8437
CENTURY	86-89	6	2.8		8442

FORD		CADILLAC			
MODELO	AÑO	CIL.	MOTOR	SISTEMA	No. PARTE
ESCALADE	02-02	8	5.3	MPFI	8456
ESCALADE	02-02	8	6.0		8456

GENERAL MOTORS		CHEVROLET				
MODELO	AÑO	CIL.	MOTOR	SISTEMA	No. PARTE	
AVALANCHE	02-02	8	5.3	MPFI	8456	
AVEO	08-17	4	1.6		8406	
BEAT	18-18	4	1.2		8485	
BLAZER	95-95	6	4.3		8442	
BLAZER	96-01	6	4.3		8456	
BLAZER NEVADA	91-94	6	3.1		TBI	8437
C2500	96-98	8	5.0		MPFI	8456
C2500	96-00	8	5.7			8456
C35	88-93	8	5.7			8437
C3500	94-98	8	5.7		TBI	8437
C3500	96-00	8	5.7	MPFI	8456	
CAMARO	96-97	8	5.7		8443	
CAMARO	00-02	8	5.7		8456	
CAMARO	95-95	8	5.7		8458	
CAMARO	98-99	8	5.7		8461	
CAVALIER	90-94	6	2.8		8448	
CAVALIER	95-97	4	2.2		8449	
CAVALIER	98-01	4	2.2		8454	
CAVALIER Z24	91-94	6	3.1		8442	
CAVALIER Z24	95-95	4	2.4		8449	
CAVALIER Z24	96-97	4	2.4		8454	
CELEBRITY	87-88	6	2.8		8437	
CELEBRITY	87-89	6	2.8		8442	
CHEVY	96-00	4	1.6		8406	
CHEVY	94-95	4	1.4		8406	
CHEVY	96-98	4	1.4		TBI	8448
CHEVY	96-98	4	1.6			8448

GENERAL MOTORS		CHEVROLET				
MODELO	AÑO	CIL.	MOTOR	SISTEMA	No. PARTE	
CHEVY	01-03	4	1.6	MPFI	8448	
CHEVY	09-12	4	1.6		8448	
CHEVY	99-03	4	1.4	TBI	84996	
CHEVY	99-03	4	1.6		84996	
CHEVY C2	04-08	4	1.6	MPFI	8448	
CHEVY MONZA	96-98	4	1.6	TBI	8448	
CHEVY MONZA	99-03	4	1.6		84996	
CHEVY PICK UP	99-03	4	1.6	MPFI	8448	
CHEYENNE CUSTOM	92-99	8	5.7		TBI	8437
CORSA	03-08	4	1.8		TBI	8448
CORVETTE	91-95	8	5.7			8442
CORVETTE	96-97	8	5.7		8443	
CORVETTE	95-96	8	5.7		8458	
EXPRESS 1500	96-06	6	4.3		8456	
EXPRESS 2500	96-02	8	5.7		8456	
EXPRESS 3500	96-02	8	5.7		8456	
IMPALA	00-03	6	3.4		8442	
IMPALA	00-03	6	3.8		8452	
LUMINA	96-96	6	3.4		8442	
LUV	00-03	4	2.2		8448	
MALIBU	97-03	6	3.1		8442	
MALIBU	97-01	4	2.4		8454	
MERIVA	04-04	4	1.8		8448	
MICROBUS	92-99	8	5.7		TBI	8437
OPTRA	06-10	4	2.0		MPFI	8406
P30	92-99	8	5.7		TBI	8437
P30	96-99	8	5.7		MPFI	8456
S10	95-97	4	2.2	8449		
S10	98-03	4	2.2	8454		
S10 MAXICAB	91-93	6	3.1	TBI	8437	
SILVERADO 1500	99-07	6	4.3	MPFI	8456	
SILVERADO 2500	00-02	8	5.3		8456	
SILVERADO 3500	01-02	8	6.0		8456	
SONORA	00-02	8	5.7		8456	
SPARK CLASSIC	11-17	4	1.2		8485	
SUBURBAN	92-99	8	5.7		TBI	8437
SUBURBAN 1500	00-02	8	5.3		8456	
SUBURBAN 2500	00-02	8	6.0		8456	
TORNADO	04-05	4	1.8		MPFI	8448
TRACKER	<b>NUEVO</b> 05-05	4	2.0		8429	
VENTURE	97-04	6	3.4	8442		

GENERAL MOTORS		OLDSMOBILE			
MODELO	AÑO	CIL.	MOTOR	SISTEMA	No. PARTE
88	92-95	6	3.8	MPFI	8470
CUTLASS	87-88	6	2.8		8437
CUTLASS	95-95	6	3.1	8442	
SILHOUETTE	91-94	6	3.1	TBI	8437
SILHOUETTE	94-95	6	3.8	MPFI	8470

GENERAL MOTORS		PONTIAC			
MODELO	AÑO	CIL.	MOTOR	SISTEMA	No. PARTE
AZTEK	01-05	6	3.4	MPFI	8442
BONNEVILLE	95-99	6	3.8		8452
BONNEVILLE	94-94	6	3.8		8470
FIREBIRD TRANS AM	94-99	8	5.7		8461
G3	07-09	4	1.6		8406
GRAND AM	99-04	6	3.4		8442
GRAND PRIX	97-01	6	3.1		8442
GRAND PRIX SC	97-01	6	3.8		8452
MATIZ	04-05	4	1.0		84973
SUNFIRE	95-97	4	2.2		8449
SUNFIRE	97-02	4	2.4		8454
SUNFIRE	98-02	4	2.2		8454

CONTINÚA»

**VÁLVULAS DE CONTROL DE AIRE EN MARCHA MÍNIMA (IAC)**

**HONDA**

MODELO	AÑO	CIL.	MOTOR	SISTEMA	No. PARTE
ACCORD	98-02	4	2.3	MPFI	84960
ACCORD	98-02	6	3.0		84978
CIVIC T/A	97-00	4	1.6		84961
CIVIC T/M	97-00	4	1.6		84951
ODYSSEY	02-04	6	3.5		84978
PILOT	03-04	6	3.5		84978

**NISSAN**

MODELO	AÑO	CIL.	MOTOR	SISTEMA	No. PARTE
D21	94-96	4	2.4	MPFI	8411
D21	97-08	4	2.4		84983
LUCINO GSR	96-00	4	2.0		84999
PLATINA	02-10	4	1.6		84991
SENTRA	92-92	4	1.6		8413
SENTRA	01-02	4	1.8		84976
SENTRA	97-00	4	2.0		84999
TSUBAME	94-99	4	1.6		8413
TSURU III	95-97	4	1.6		8413
TSURU III	98-16	4	1.6		84983
TSURU III GSR 2000	94-96	4	2.0		8414

**PEUGEOT**

MODELO	AÑO	CIL.	MOTOR	SISTEMA	No. PARTE
206 XT	00-03	4	1.4	MPFI	84993

**RENAULT**

MODELO	AÑO	CIL.	MOTOR	SISTEMA	No. PARTE
CLIO	02-10	4	1.6	MPFI	84991
MEGANE	01-03	4	2.0		84991
SCENIC	01-04	4	2.0		84991

**TOYOTA**

MODELO	AÑO	CIL.	MOTOR	SISTEMA	No. PARTE
AVANZA	07-15	4	1.5	MPFI	8431

**VOLKSWAGEN**

MODELO	AÑO	CIL.	MOTOR	SISTEMA	No. PARTE
COMBI	93-96	4	1.8	MPFI	8407
COMBI	97-01	4	1.8		8410
DERBY	98-01	4	1.8		8407
DERBY	02-09	4	1.8		8410
GOLF A2	90-92	4	1.8		8407
GOLF A3	93-96	4	1.8		8407
GOLF A3	93-98	4	2.0		8410
GOLF A3 VR6	95-98	6	2.8		8410
JETTA A2 FBU	90-92	4	1.8		8407
JETTA A3	93-96	4	1.8		8407
JETTA A3	93-99	4	2.0		8410
JETTA A3 VR6	95-98	6	2.8		8410
POINTER	98-99	4	1.8		8405
POINTER	00-09	4	1.8		84994
POINTER GTI	00-03	4	2.0		84994
POINTER PICK UP	99-99	4	1.8		8405
POINTER PICK UP	00-04	4	1.8		84994
SEDAN	93-04	4	1.6		8408
VAN	03-09	4	1.8		84994

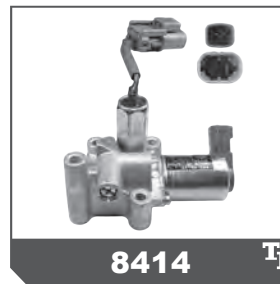



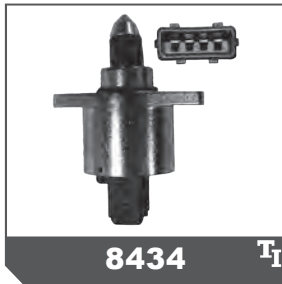
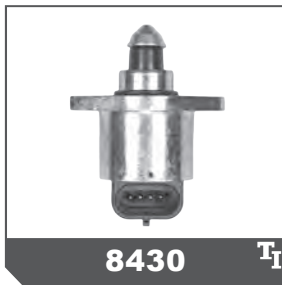
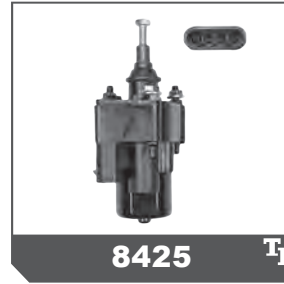
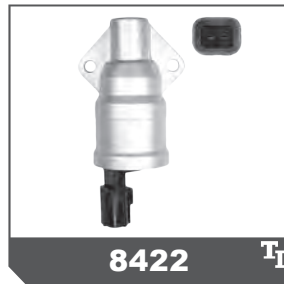
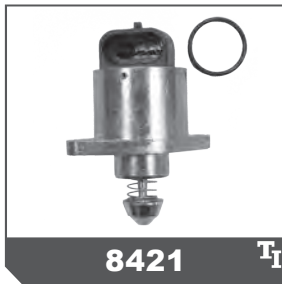
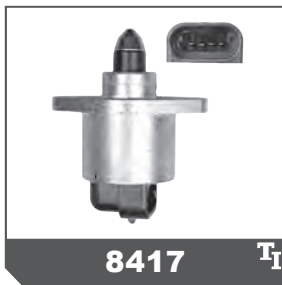

**VÁLVULAS DE CONTROL DE AIRE EN MARCHA MÍNIMA (IAC)**

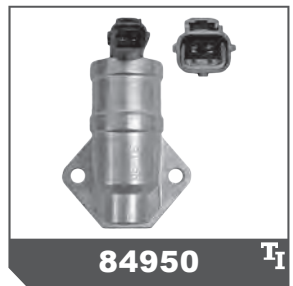
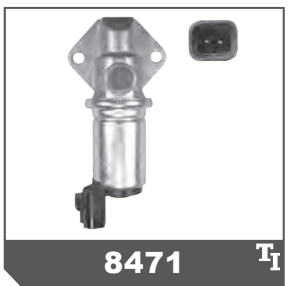

VÁLVULAS DE CONTROL DE AIRE EN MARCHA MÍNIMA (IAC)

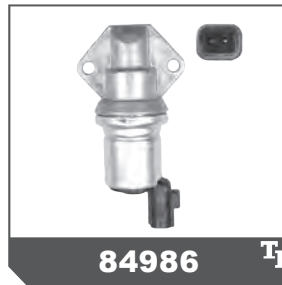
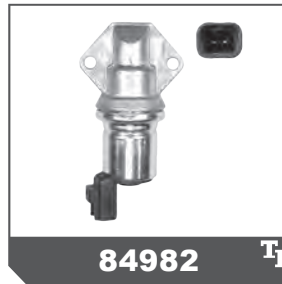
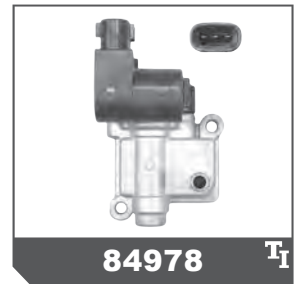
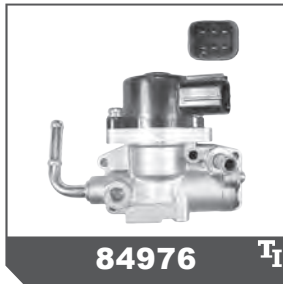
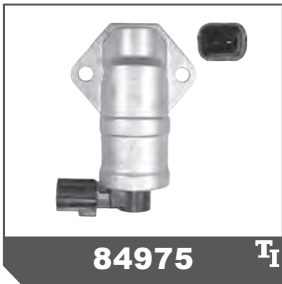
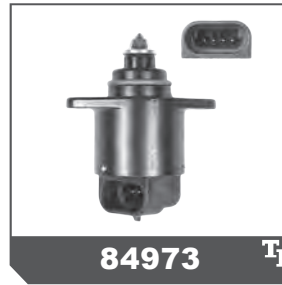
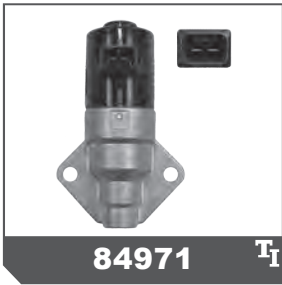
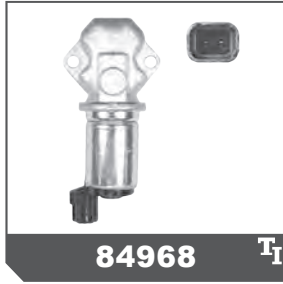

**VÁLVULAS DE CONTROL DE AIRE EN MARCHA MÍNIMA (IAC)**

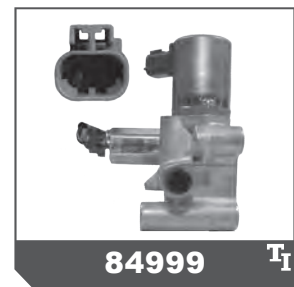
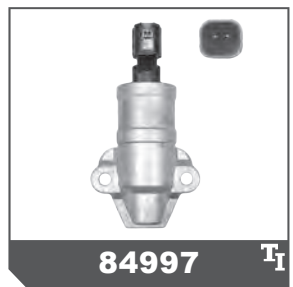

**SU FUNCIÓN:**

Recirculan los gases al múltiple de entrada para mantener baja la temperatura de combustión y reducir las emisiones.

**SÍNTOMAS DE FALLA:**

Marcha mínima inestable, explosiones en el escape, sobrecalentamiento y pérdida de potencia.

**MANTENIMIENTO/SERVICIO:**

Revisar cada 12,000 - 15,000 millas (19,000-24,000 kms.) y durante cada afinación.

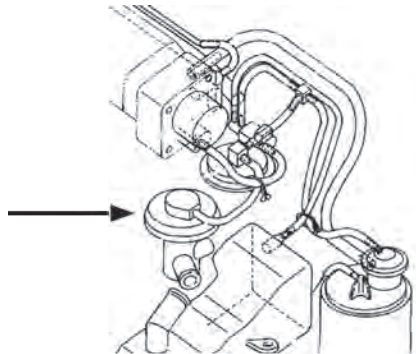

CHRYSLER					
MODELO	AÑO	CIL.	MOTOR	SISTEMA	No. PARTE
CIRRUS TURBO	96-96	4	2.4	MPFI	10312
CIRRUS TURBO	97-97	4	2.4		10709
CIRRUS TURBO	00-00	4	2.4		10709
GRAND VOYAGER	01-02	6	3.8		10703
TOWN & COUNTRY	01-02	6	3.8		10703
VOYAGER	01-02	6	3.3		10703

CHRYSLER DODGE					
MODELO	AÑO	CIL.	MOTOR	SISTEMA	No. PARTE
H100 CHASIS	03-05	4	2.4	MPFI	10707
RAM 2500	94-96	8	5.2		10710
RAM 2500	94-96	8	5.9		10710
RAM 3500	94-96	8	5.9		10710
RAMCHARGER	92-93	8	5.9		10710
STRATUS	95-96	4	2.4		10312
STRATUS	97-00	4	2.4	10709	

CHRYSLER JEEP					
MODELO	AÑO	CIL.	MOTOR	SISTEMA	No. PARTE
GRAND CHEROKEE	93-96	6	4.0	MPFI	10710
GRAND CHEROKEE	93-96	8	5.2		10710

FORD					
MODELO	AÑO	CIL.	MOTOR	SISTEMA	No. PARTE
CONTOUR	95-00	6	2.5	MPFI	10462
ECONOLINE E-150	95-95	6	4.9		10604
ESCAPE	04-08	6	3.0		10708
ESCORT	94-96	4	1.9		10436
F-150	94-95	6	4.9		10604
F-250	96-97	8	5.0		10455
F-250	94-95	8	5.0		10604
F-250	88-97	8	5.8		10604
F-350	94-97	8	5.0		10455
F-350	94-96	8	5.0		10604
F-350	92-97	8	5.8		10604
FOCUS	00-03	4	2.0		10702
GHIA	91-91	4	2.3		10436
RANGER	96-97	4	2.3		10458
THUNDERBIRD	95-95	8	4.6		10458
THUNDERBIRD	91-93	8	5.0		10604

FORD MERCURY					
MODELO	AÑO	CIL.	MOTOR	SISTEMA	No. PARTE
GRAND MARQUIS	92-95	8	4.6	MPFI	10458
MARINER	05-08	6	3.0		10708
MYSTIQUE	95-00	6	2.5		10462
TOPAZ	91-94	4	2.3		10436

GENERAL MOTORS BUICK					
MODELO	AÑO	CIL.	MOTOR	SISTEMA	No. PARTE
REGAL	94-95	6	3.8	MPFI	10519

GENERAL MOTORS CHEVROLET					
MODELO	AÑO	CIL.	MOTOR	SISTEMA	No. PARTE
AVALANCHE	02-02	8	5.3	MPFI	10516
BEAT	18-18	4	1.2		10516
BLAZER	95-01	6	4.3	TBI	10516
BLAZER NEVADA	91-94	6	3.1		10510
C35	92-93	8	5.7	TBI	10510
C3500	94-98	8	5.7		10510
CAVALIER	95-95	4	2.2	MPFI	10512
CAVALIER	96-99	4	2.2		10518
CAVALIER	91-94	6	2.8		10551
CAVALIER Z24	96-97	4	2.4		10518
CAVALIER Z24	91-94	6	3.1		10551
CHEYENNE CUSTOM	92-99	8	5.7		TBI
EXPRESS 1500	97-03	6	4.3	MPFI	10516
EXPRESS 2500	96-02	8	5.7		10516
EXPRESS 3500	96-02	8	5.7		10516
KODIAK	99-01	8	7.4	MPFI	10516
MALIBU	97-01	6	3.1		10515
MALIBU	97-00	4	2.4	TBI	10518
MATIZ	11-15	4	1.0		10705
MICROBUS	92-99	8	5.7	TBI	10510
P30	92-99	8	5.7		10510
S10 MAXICAB	91-93	6	3.1	MPFI	10510
SILVERADO 1500	99-03	6	4.3		10516
SILVERADO 2500	99-02	8	5.3		10516
SILVERADO 3500	99-01	8	7.4		10516
SPARK CLASSIC	11-17	4	1.2		10516
SUBURBAN	93-97	8	5.7		10501
SUBURBAN	92-99	8	5.7	TBI	10510
SUBURBAN 1500	00-02	8	5.3	MPFI	10516
VENTURE	97-99	6	3.4		10515

GENERAL MOTORS OLDSMOBILE					
MODELO	AÑO	CIL.	MOTOR	SISTEMA	No. PARTE
CUTLASS	91-95	6	3.1	MPFI	10551
SILHOUETTE	91-94	6	3.1	TBI	10510
SILHOUETTE	91-94	6	3.8		10510

GENERAL MOTORS PONTIAC					
MODELO	AÑO	CIL.	MOTOR	SISTEMA	No. PARTE
BONNEVILLE	94-95	6	3.8	MPFI	10519
MATIZ	07-10	4	1.0		10705
SUNFIRE	97-00	4	2.4		10518

NISSAN					
MODELO	AÑO	CIL.	MOTOR	SISTEMA	No. PARTE
LUCINO GSR	96-00	4	2.0	MPFI	10700
SENTRA	96-00	4	2.0		10700
TSURU II T/A	92-92	4	1.6	CARBURADO	10698
TSURU II T/M	92-92	4	1.6		10699
TSURU III	93-94	4	1.6	MPFI	10696



**VÁLVULAS DE RECIRCULACIÓN DE GASES (EGR)**

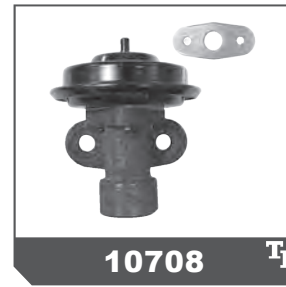
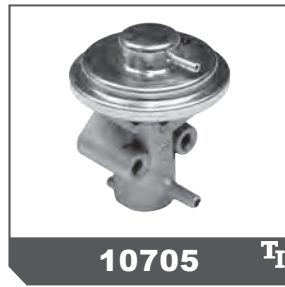
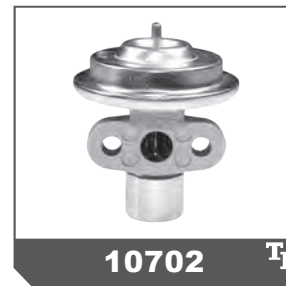
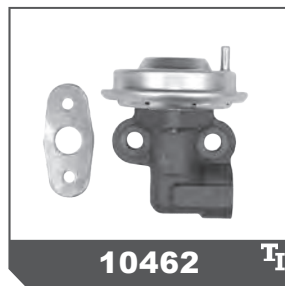
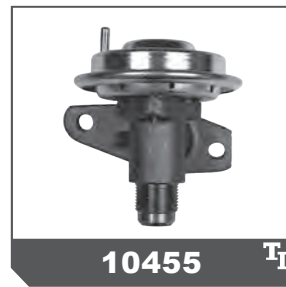

## VÁLVULAS DE RECIRCULACIÓN DE GASES (EGR)



## VÁLVULAS MAGNÉTICA PARA DEPÓSITO DE CARBÓN (AKF)

### VOLKSWAGEN

MODELO	AÑO	CIL.	MOTOR	SISTEMA	No. PARTE
SEDAN	93-04	4	1.6	MPFI	8600



## VÁLVULAS DE SOLENOIDE PARA SISTEMA EGR (EVP)

### FORD

MODELO	AÑO	CIL.	MOTOR	SISTEMA	No. PARTE
CONTOUR	95-00	6	2.5	MPFI	10811
CONTOUR	96-00	4	2.0		10811
ESCAPE	01-07	6	3.0		10811
ESCORT	94-95	4	1.9		10810
ESCORT	97-01	4	2.0		10811
EXPEDITION	97-04	8	4.6		10811
EXPEDITION	97-04	8	5.4		10811
EXPLORER	96-03	6	4.0		10811
F-150	92-94	6	3.8		10810
F-350 SUPER DUTY	99-00	8	5.4		10811
FOCUS	00-03	4	2.0		10811
GHIA	91-91	4	2.3		10810
GHIA	92-94	6	3.0		10810
MUSTANG	96-04	8	4.6		10811
RANGER	96-02	6	3.0		10811
TAURUS	91-91	6	3.8		10810
THUNDERBIRD	89-90	6	3.8		10810
THUNDERBIRD	91-93	8	5.0		10810
WINDSTAR	96-03	6	3.8		10811

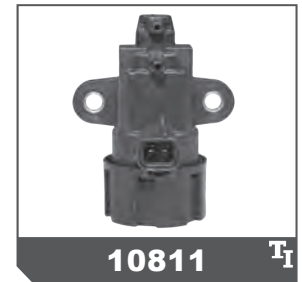

### FORD

### LINCOLN

MODELO	AÑO	CIL.	MOTOR	SISTEMA	No. PARTE
NAVIGATOR	98-04	8	5.4	MPFI	10811
TOWN CAR	96-02	8	4.6		10811

### FORD

### MERCURY

MODELO	AÑO	CIL.	MOTOR	SISTEMA	No. PARTE
GRAND MARQUIS	92-94	8	4.6	MPFI	10810
GRAND MARQUIS	95-04	8	4.6		10811
MARINER	05-07	6	3.0		10811
MYSTIQUE	95-00	6	2.5		10811
MYSTIQUE	96-00	4	2.0		10811
SABLE	96-04	6	3.0		10811
TOPAZ	91-94	4	2.3		10810

# Descarga nuestra app: Tomco Fuel Injection

**TOMCO<sup>TI</sup>**

ESPECIALISTAS EN INYECCIÓN

Videos y  
redes sociales

Consulta  
catálogo

Home



Nosotros



Contáctanos,  
escribenos

Disponible en:



Tomcofuelinjection |



Tomcodemexico



ESPECIALISTAS EN INYECCIÓN



Sistema de Gestión de Calidad  
ISO-9001:2015  
Certificado por  
American Trust Registrar, S.C.  
Norma de referencia  
NMX-CC-9001-IMNC-2015  
Para efectos de mayor  
información consultar la página  
[www.tomco.com.mx](http://www.tomco.com.mx)



[www.tomco.com.mx](http://www.tomco.com.mx)

DISTRIBUIDORA TRIEM, S.A. DE C.V.  
Av. Vasco de Quiroga #3900 Corporativo Diamante Santa Fe  
Torre "C" 2do. piso, int. 203 C1, Col. Lomas de Santa Fe  
Del. Cuajimalpa, C.P. 05300, México D.F.  
Tel. +52 (55) 5000 6777, Fax +52 (55) 5276 9446

TODOS LOS DERECHOS RESERVADOS, PROHIBIDA SU REPRODUCCIÓN TOTAL O PARCIAL  
SIN PREVIA AUTORIZACIÓN

